

N&C

Ironmongery
collection

The Nicholls & Clarke Group is a business dedicated to the manufacture and supply of the finest building materials. Founded in 1875 in London, we have grown from servicing the capitals' building trades to becoming the largest privately owned national manufacturer and distributor of fine quality building products.

Quality manufacturing is at the core of our business and comes as standard. We own state of the art manufacturing facilities based across the UK and Central Europe. This gives us the broadest manufacturing capability available, allowing us to offer an extensive portfolio of product, more specialised than that of any of our competitors.

Our distribution network is supported with our private fleet of over 110 commercial vehicles. This gives us full logistical control from the point of manufacture through to delivery to site. We offer a nationwide delivery service, be that to site, home or commercial address. The vast majority of our deliveries are made on a next day basis.



Complete Ironmongery Specialists

At Nicholls & Clarke, we offer a fully comprehensive collection of architectural ironmongery and builders hardware ideal for commercial or domestic use. Established in 1875, Ironmongery continues to be a core part of the business which has led to our proud heritage, loyal customer base and invaluable industry expertise.

Our comprehensive portfolio of the latest architectural ironmongery products are a vital element for consideration during the design stage of any building, whether a refurbishment or new build. As a result we have made it imperative that the products we offer are of high quality, fit the application purpose, comply with the relevant BS/EN Standards and are competitive. As long term members of the Guild of Architectural Ironmongers, we have a fully qualified team with full technical knowledge and the ability to prepare detailed schedules from architect drawings.



Experience

Established in 1875, Nicholls & Clarke has pedigree that has been developed over many years. Through great heritage, we have gained a depth of knowledge and invaluable experience in the manufacturing and supplying of ironmongery products to the construction industry. We have experience across many industries with a huge portfolio of products suited to most project environments.

Total Solution Providers

Part of the Nicholls & Clarke Group, we have the ability to offer a comprehensive range of products from ironmongery, sanitaryware, heavyside products to wall and floor tiles, tiling solutions and independent living solutions. We offer the complete package so that you can benefit from dealing with one source, making it easier to co-ordinate project supplies.

Technical Specification Service

This document will make the process of selecting the correct products for the required environment much simpler through information on client needs as well as legislation. If in doubt, our expert team are on hand to guide you in the right direction on specific project queries.

Environment

As an ISO14001 company, sustainability is a core part of our company agenda. As well as various carbon offsetting programmes in place, we invest a great deal in manufacturing and developing solutions that help reduce our carbon footprint.

Inventors & Innovators

Nicholls & Clarke continue to be at the forefront of innovation, embracing new technology within the industry and better defining our portfolio with products that perform, but where style and quality are at its peak. As inventors, we continue to engage in research and development and understand industry and customer requirements in order to present solutions that overcome day to day problems.

24 Hour Nationwide Delivery

Nicholls & Clarke are unique in being able to offer nationwide, next day delivery, even when you order up to 5pm the day before* and there is no minimum order requirement. We operate out of 16 branches nationwide so can offer localised delivery, and with over 60,000 product lines you also have the option, in most cases, to collect.

Research & Development

Prior to going to market, we undergo rigorous testing of all our products to ensure that performance is to a high standard. All products are tested to meet the relevant standards and regulations.

Customer Care

We aim to provide you with an outstanding level of customer service that will help to further enhance the service you offer to your clients. We monitor our performance levels and strive to achieve 100% client satisfaction. We believe that open channels of communication with our customers, coupled with their feedback are a sure way of further improving our customers buying experience.

Product Features Key



Commercial Use

Products suitable for use in commercial applications



Education

Designed to be suitable for use within educational establishments



CE

Complies with European health, safety and environmental legislation



Domestic Use

Products suitable for use in the home/private property



Fire

Fire rated for 30min - 60 mins and 120mins



British Standards

Products that comply with British Standards



Disabled Use

Products and solutions suitable for people with different levels of abilities



Guarantee

Products that come with the associated manufacturers guarantee



Certifire

The international certification mark of fire safety



Secure by Design

Secure by Design endorsed by the UK Police



Guarantee

Products that come with the associated manufacturers guarantee



Contents

- Door Furniture 6 - 40
- Locks, Latches & Security 41 - 58
- Hinges 59 - 66
- Door Controls 67 - 78
- Fire Control 79 - 85
- Signage 87 - 104
- Sliding Door Gear 105 - 112
- Cabinet Fittings and Shelving Systems 113 - 124
- Window Fittings 125 - 136
- Bolts, Stops and Accessories 137 - 146
- Anti Ligature Fittings 149 - 152
- General Hardware 153 - 166

Commercial Partners

We have worked in partnership with an extensive list of customers throughout the U.K and worldwide on some of the most demanding projects imaginable. Our first UK and export project was completed over 55 years ago, yet our products continue to perform today and will continue to do so for the life of the building or project.

This pedigree has created ultimate confidence in the Nicholls & Clarke range of products. Today we have N&C products specified by many recognised UK and international brands and are also working with many of the UK's premier contractors who in turn work in partnership with these brands.

N&C Ironmongery

Storage

It is essential that all ironmongery received on to site is stored in good clean, dry conditions prior to fixing. All items are carefully packed before delivery to avoid damage and are supplied complete with fixings. Where necessary, fixing instructions are included with each item. During construction, ironmongery must be protected after fitting. Care should be taken to avoid fitting any ironmongery whilst "wet" trades are still in progress. Fittings must be stored away from abrasives, acids and other corrosive materials.

Fixings

Each item of ironmongery should be fitted in accordance with the appropriate fitting instructions, using the fixings supplied. No substitution of fixings should be undertaken without reference to Nicholls & Clarke. Such substitution may invalidate any performance statement given or implied in product literature or fixing instructions.

Installation

All ironmongery supplied by Nicholls & Clarke has been carefully selected to provide optimum performance for the individual project. Considerations include fitness for purpose to suit the necessary level of performance, fire/safety requirements according to appropriate standards and regulations, co-ordination and compatibility for purpose, backed by a full technical service.

The correct installation of all items of ironmongery is essential to achieve the performance levels stated

Our history & heritage

1875, the journey begins...

Founded in 1875, Nicholls & Clarke have grown from strength to strength with over 135 years of experience and expertise in the manufacture and distribution of high quality building products. The journey saw huge developments into new areas of trade through diversifying and ongoing product development to meet the needs of different markets.



The Nicholls & Clarke building in Shoreditch, London, in one of its many guises through the progression and development of the company since 1875

Nicholls & Clarke was first established in Shoreditch London in 1875 as a glass business. By 1880, it had expanded into Ironmongery, the beginning of a journey we continue today.

In years where the railway were in their infancy, slavery was still legal in southern states and around the world, where neither Germany or Italy where unified countries and the Great Duke of Wellington was still alive, Nicholls and Clarke were servicing the capital's trade from the heart of Shoreditch, London.

During our history, Nicholls & Clarke has merged other ironmongery companies into its business by acquisition including GIFCO (General Iron Foundry Co.), Carter and Aynsley and Lips Locks which enabled the company to grow its specialist ironmongery division. We have been an influential member of the Guild of Architectural Ironmongers, involved in various Guild Committees over many years.



We have a history for supplying Ironmongery to some of the most iconic buildings in the UK. Nicholls & Clarke Ironmongery was soon being specified all over the Country. Many British hotels and other outstanding buildings were being fitted with master keyed suites of locks of exceptional quality. Nicholls & Clarke has supplied buildings such as the Old Bailey, the Dorchester Hotel and beautiful Royal buildings and premises such as the supply of railings for the Duke of York's riding school in Chelsea.

Archive: Old Bailey Ironmongery Schedule of Works

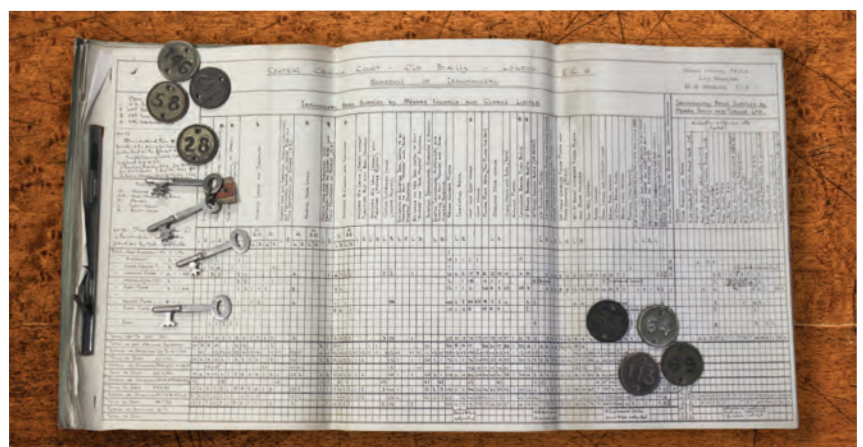

Inventors of the RADAR lock

The company's proudest achievement was probably the creation of the RADAR lock . The worlds only universal key scheme which allows disabled users to safely find a toilet facility which can be exclusively used by those that need it most. This invention has been in operation for 40 years using the same key and lock types, which are still working in toilets built years ago or installed today. Each year, thousands of keys and locks are supplied to increase the access for facilities provided, subject to Building Standards - Document M.

The N&C Phlexicare Radar lock now forms part of the design of the BS8300 compliant Document M toilet facilities offered by Nicholls & Clarke to ensure specifiers and builders can choose with confidence products that will conform to standards, offer longevity, stylish design and ease of installation. Our dedication, to continually develop our ironmongery range incorporating the latest designs, whilst maintaining our heritage of quality and value is as strong today as was nearly 140 years ago .

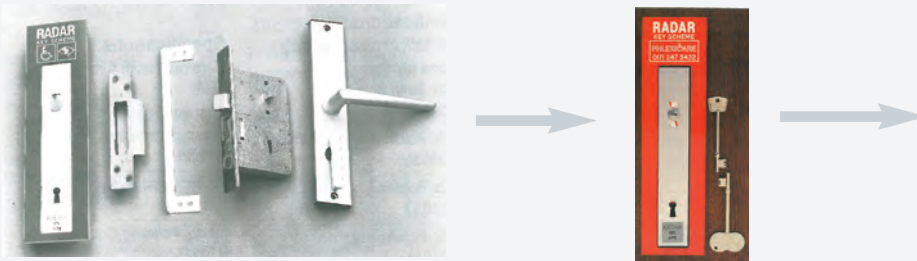

Our collection of Nicholls & Clarke specialist ironmongery catalogues stretch back to the late 1800's, with our largest ever ironmongery catalogue issued in 1900 with over 550 pages devoted to these goods alone. Each catalogue shows a true reflection of the fittings of its time.



Door Furniture

Our comprehensive range of door furniture is ideal for commercial or domestic environments and is available in a range of materials and finishes. Includes door knobs or lever handles on rose and backplates, pull handles, push plates, escutcheons, door packs as well as a range of front door furniture.

Where appropriate, our products meet British and European Standard requirements and testing methods covering lever handles and knob furniture (BS EN 1906).



N&C Contractor Range

A popular range of door furniture created for medium duty, medium traffic commercial environments.

Available in anodised aluminium with both polished & satin finishes.

N&C Contractor is also available in polished brass and polished chrome with a full range of matching accessories.



N&C Contractor Lever Handle

- Safety lever handle on sprung concealed fix round rose
- Anodised aluminium

Code	Dia	Rose	Finish
H3900001	19mm	50mm	Polished Aluminium
H0642517	19mm	50mm	Satin Aluminium



N&C Contractor Lever Latch Handle Short

- Safety lever latch handle on concealed fix short backplate
- Anodised aluminium

Code	Dia	Backplate	Finish
H3901001	19mm	100x40mm	Polished Aluminium



N&C Contractor Lever Latch Handle

- Safety lever latch handle on concealed fix long backplate
- Anodised Aluminium

Code	Dia	Backplate	Finish
H3901101	19mm	152x40mm	Polished Aluminium
H0642513	19mm	170x40mm	Satin Aluminium



N&C Contractor Lever Standard Lock Handle

- Safety lever latch handle on concealed fix long backplate
- Anodised Aluminium ● Pierced For Standard Keyway

Code	Dia	Backplate	Finish
H3901201	19mm	152x40mm	Polished Aluminium
H0642512	19mm	170x40mm	Satin Aluminium



N&C Contractor Lever Euro Lock Handle

- Safety lever latch handle on concealed fix long backplate
- Anodised aluminium ● Pierced for euro profile cylinder

Code	Dia	Backplate	Finish
H3901301	19mm	152x40mm	Polished Aluminium
H0642515	19mm	170x40mm	Satin Aluminium



N&C Contractor Lever Oval Lock Handle

- Safety lever latch handle on concealed fix long backplate
- Anodised aluminium ● Pierced for oval profile cylinder

Code	Dia	Backplate	Finish
H3901501	19mm	152x40mm	Polished Aluminium
H0642516	19mm	170x40mm	Satin Aluminium



N&C Contractor Lever Bathroom Handle

- Safety lever latch handle on concealed fix long backplate with external indicator/release & internal thumbturn
- Anodised aluminium

Code	Dia	Backplate	Finish
H3901401	19mm	152x40mm	Polished Aluminium
H0642514	19mm	170x40mm	Satin Aluminium



N&C Contractor Bathroom Thumbturn

- Bathroom indicator/release on round rose
- Internal thumbturn • Anodised aluminium

Code	Dia	Finish
H3904401	52mm	Polished Aluminium
H0642528	52mm	Satin Aluminium



N&C Contractor Bathroom Extended Thumbturn

- Bathroom indicator/release on round rose
- Internal thumbturn • Anodised aluminium

Code	Dia	Finish
H3904601	52mm	Polished Aluminium
H0642529	52mm	Satin Aluminium



N&C Contractor Standard Keyway Escutcheon

- Concealed fix escutcheon
- Standard keyway • Anodised aluminium

Code	Dia	Finish
H3904101	52mm	Polished Aluminium
H0642526	52mm	Satin Aluminium



N&C Contractor Euro Profile Escutcheon

- Concealed fix escutcheon
- Euro profile cylinder • Anodised aluminium

Code	Dia	Finish
H3904201	52mm	Polished Aluminium
H0642525	52mm	Satin Aluminium



N&C Contractor Oval Profile Escutcheon

- Concealed fix escutcheon
- Oval profile cylinder • Anodised aluminium

Code	Dia	Finish
H3904301	52mm	Polished Aluminium
H0642527	52mm	Satin Aluminium



N&C Contractor Standard Keyway Escutcheon

- Stamped round escutcheon
- Standard keyway • Anodised aluminium

Code	Dia	Finish
H0332501	32mm	Satin Aluminium
• with Cover Plate		
H0331013	32mm	Satin Aluminium



N&C Contractor Pull Handle

- Straight pull handle with bolt through fixings
- Anodised aluminium

Code	Size	Finish
H3906101	152x19mm	Polished Aluminium
H3906201	225x19mm	Polished Aluminium
H3906301	305x19mm	Polished Aluminium
H0642518	152x19mm	Satin Aluminium
H0642519	225x19mm	Satin Aluminium
H0642520	300x19mm	Satin Aluminium
H0642521	425x19mm	Satin Aluminium
H0642522	600x19mm	Satin Aluminium



N&C Contractor Pull Handle

- Straight pull handle on concealed fix round roses
- Anodised aluminium

Code	Size	Finish
H3906401	152x19mm	Polished Aluminium
H3906501	225x19mm	Polished Aluminium
H3906601	305x19mm	Polished Aluminium



N&C Contractor Pull Handle

- Straight pull handle on backplate on plate • Screw fix
- Anodised aluminium

Code	Handle	Plate	Finish
H3906701	225x19mm	300x75mm	Polished Aluminium
H3906801	305x19mm	375x75mm	Polished Aluminium



N&C Contractor Finger Plate

- Plain finger plate with square corners
- Drilled & countersunk • Anodised aluminium

Code	Size	Finish
H0380001	305x64x1.5mm	Polished Aluminium
H0380601	305x76x1.5mm	Polished Aluminium
H0380601	330x76x1.5mm	Polished Aluminium

Other sizes made to order



N&C Contractor Finger Plate

- Engraved finger plate "push" with square corners
- Drilled & countersunk • Anodised aluminium

Code	Size	Finish
H0381001	305x76x1.5mm	Satin Aluminium



N&C Contractor Flush Bolt

- Lever action flush bolt • Anodised aluminium

Code	Size	Finish
H3907001	150x25mm	Polished Aluminium
H3907101	200x25mm	Polished Aluminium
H3907201	305x25mm	Polished Aluminium
H0642530	152x19mm	Satin Aluminium
H0642531	203x19mm	Satin Aluminium

N&C Contractor Kicking Plate

- Kicking Plate with Square Corners
- Drilled & Countersunk • Anodised Aluminium

Code	Size	Finish
H0385001	675x152x1.5mm	Satin Aluminium
H0385011	750x152x1.5mm	Satin Aluminium
H0385021	825x152x1.5mm	Satin Aluminium

Other sizes made to order



N&C Contractor Wall Door Stop

- Wall mounted buffered door stop on round rose
- Anodised aluminium

Code	Projection	Finish
H0560001	65mm	Satin Aluminium
H0560011	76mm	Satin Aluminium

N&C Contractor wall door stop not on rose

H0642533	76mm	Satin Aluminium
----------	------	-----------------



N&C Contractor Floor Door Stop

- Floor mounted shielded door stop for timber floor
- Anodised aluminium

Code	Dia	Finish
H0562001	32mm	Polished Aluminium



N&C Contractor Floor Door Stop

- Floor mounted oval door stop for timber floor
- Anodised aluminium

Code	Size	Finish
H0563501	44x51mm	Polished Aluminium
H0642532	44x51mm	Silver Aluminium



N&C Contractor Cylinder Pull

- Concealed fix cylinder pull for rim cylinder
- Anodised aluminium

Code	Finish
H0355501	Polished Aluminium



N&C Contractor Hooks

- Strip pattern • Anodised aluminium

Hat & Coat	Code	Finish
	H0580001	Satin Aluminium
Robe Hook	H0580502	Satin Aluminium



N&C Contractor Cupboard Knob

- Dished pattern cupboard knob • bolt through fixing
- Anodised aluminium

Code	Dia	Finish
H0642501	35mm	SilvSatin Aluminium
H0642511	40mm	Satin Aluminium



N&C Contractor Lever Handle

- Safety lever handle on sprung concealed fix round rose

Code	Dia	Rose	Finish
H3900002	19mm	50mm	Polished Brass



N&C Contractor Bathroom Indicator

- Bathroom indicator/release on round rose
- Internal thumbturn

Code	Dia	Finish
H3904402	50mm	Polished Brass



N&C Contractor Pull Handle

- Straight pull handle on concealed fix round roses

Code	Size	Finish
H3906502	225mm	Polished Brass
H3906602	305mm	Polished Brass



N&C Contractor Standard Keyway Escutcheon

- Concealed Fix Escutcheon
- Standard Keyway

Code	Dia	Finish
H3904102	50mm	Polished Brass



N&C Contractor Euro Profile Escutcheon

- Concealed Fix Escutcheon
- Euro Profile Cylinder

Code	Dia	Finish
H3904202	50mm	Polished Brass



N&C Contractor Oval Profile Escutcheon

- Concealed Fix Escutcheon
- Oval Profile Cylinder

Code	Dia	Finish
H3904302	50mm	Polished Brass



N&C Contractor Plain Finger Plate

- Plain Finger Plate with Square Corners
- Drilled & Countersunk

Code	Size	Finish
H0380502	305x76x1.5mm	Polished Brass

Other sizes made to order



N&C Contractor Engraved Finger Plate "Push"

- Engraved Finger Plate "Push" with Square Corners
- Drilled & Countersunk

Code	Size	Finish
H0381002	305x76x1.5mm	Polished Brass



N&C Contractor Lever Action Flush Bolt

- Lever Action Flush Bolt

Code	Size	Finish
H3907002	150x19mm	Polished Brass
H3907102	200x19mm	Polished Brass
H3907202	305x25mm	Polished Brass

N&C Contractor Kicking Plate

- Kicking Plate with Square Corners
- Drilled & Countersunk

Code	Size	Finish
H0386501	675x152x1.5mm	Polished Brass
H0386511	750x152x1.5mm	Polished Brass
H0386521	825x152x1.5mm	Polished Brass

Other sizes made to order

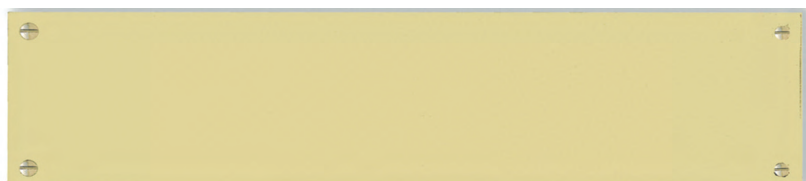



N&C Contractor Lever Handle

- Safety lever handle on sprung concealed fix round rose

Code	Dia	Rose	Finish
H3900003	19mm	50mm	Polished Chrome



N&C Contractor Bathroom Indicator

- Bathroom indicator/release on round rose
- Internal thumbturn

Code	Dia	Finish
H3904403	50mm	Polished Chrome



N&C Contractor Pull Handle

- Straight pull handle on concealed fix round roses

Code	Size	Finish
H3906503	225mm	Polished Chrome
H3906603	305mm	Polished Chrome



N&C Contractor Standard Keyway Escutcheon

- Concealed Fix Escutcheon
- Standard Keyway

Code	Dia	Finish
H3904103	50mm	Polished Chrome



N&C Contractor Euro Profile Escutcheon

- Concealed Fix Escutcheon
- Euro Profile Cylinder

Code	Dia	Finish
H3904203	50mm	Polished Chrome



N&C Contractor Oval Profile Escutcheon

- Concealed Fix Escutcheon
- Oval Profile Cylinder

Code	Dia	Finish
H3904303	50mm	Polished Chrome



N&C Contractor Finger Plate

- Plain finger plate with square corners
- Drilled & countersunk

Code	Size	Finish
H0380502	305x76x1.5mm	Polished Stainless Steel

Other sizes made to order



N&C Contractor Finger Plate

- Engraved finger plate "push" with square corners
- Drilled & countersunk

Code	Size	Finish
H0381003	305x76x1.5mm	Polished Stainless Steel



N&C Contractor Flush Bolt

- Lever action flush bolt

Code	Size	Finish
H0489101	150x19mm	Polished Chrome
H0489102	200x19mm	Polished Chrome
H0489103	305x25mm	Polished Chrome

N&C Contractor Kicking Plate

- Kicking plate with square corners
- Drilled & countersunk

Code	Size	Finish
H0387701	675x152x1.5mm	Polished Stainless Steel
H0387711	750x152x1.5mm	Polished Stainless Steel
H0387721	825x152x1.5mm	Polished Stainless Steel

Other sizes made to order



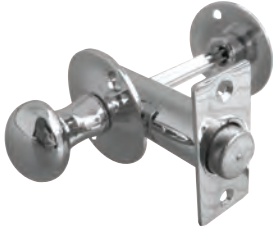

N&C Contractor Bathroom Oval Turn Knob & Release With Bolt

• Bathroom oval turn knob and release on round rose with mortice bolt

Code	Dia	Backset	Finish
H8001044	32mm	32mm	Polished Chrome



N&C Contractor Bathroom Oval Turn Knob

• Bathroom oval turn knob on round rose splined spindle

Code	Dia	Finish
H8001070	32mm	Polished Chrome



N&C Contractor Bathroom Oval Turn Knob and Release Without Bolt

• Bathroom oval turn knob & release on round rose
• Emergency release • 5mm square spindled

Code	Dia	Finish
H8001045	32mm	Polished Chrome



N&C Contractor Mortice Security Bolt

• Mortice security bolt • Splined follower

Code	Backset	Finish
H8001046	32mm	Polished Chrome



N&C Contractor Bathroom Indicator Bolt

• Vacant/engaged indicator with emergency release

Code	Internal	External	Finish
H8001067	60x40mm	50x50mm	Polished Chrome



N&C Contractor Cabin Hook & Eye

• Silent pattern cabin hook & eye

Code	Size	Finish
H8001062	102mm	Polished Chrome
H8001042	152mm	Polished Chrome

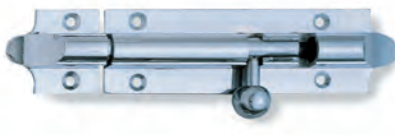

N&C Contractor Bell Pattern Barrel Bolt

• Straight bell pattern barrel bolt

Code	Size	Finish
H8001054	100x32mm	Polished Chrome
H8001055	150x32mm	Polished Chrome



N&C Contractor Bell Pattern Barrel Bolt

• Necked bell pattern barrel bolt

Code	Size	Finish
H8001056	100x32mm	Polished Chrome
H8001057	150x32mm	Polished Chrome



N&C Contractor Floor Door Stop

• Oval floor door stop with shield & rubber buffer

Code	Finish
H8001049	Polished Chrome



N&C Contractor Projection Door Stop

• Projection door stop on round rose with rubber buffer

Code	Size	Finish
H8001048	75mm	Polished Chrome



N&C Contractor Floor Door Stop

• Circular floor door stop with shield & rubber buffer

Code	Size	Finish
H8001063	40x30mm	Polished Chrome



N&C Contractor Spring Door Stop

• "Spring" projection door stop with rubber buffer

Code	Size	Finish
H8001069	75mm	Polished Chrome

N&C Specifier Range

Our durable range of door furniture, manufactured in stainless steel. Perfect for commercial projects with busy pedestrian traffic areas such as corporate offices, corridors etc.

Available in polished and satin finishes with a range of matching accessories.



N&C Specifier Lever Handle

- Safety lever handle on sprung concealed fix round rose

Code	Dia	Rose	Finish
H3700004	19mm	50mm	Satin Stainless Steel
H3700003	19mm	50mm	Polished Stainless Steel



N&C Specifier Lever Latch Handle

- Safety lever latch handle on concealed fix long backplate

Code	Dia	Backplate	Finish
H3701104	19mm	165x45mm	Satin Stainless Steel
H3701103	19mm	165x45mm	Polished Stainless Steel



N&C Specifier Lever Lock Handle

- Safety lever lock handle on concealed fix long backplate
- Pierced for standard keyway

Code	Dia	Backplate	Finish
H3701204	19mm	165x45mm	Satin Stainless Steel
H3701203	19mm	165x45mm	Polished Stainless Steel



N&C Specifier Lever Lock Handle

- Safety lever lock handle on concealed fix long backplate
- Pierced for euro profile cylinder

Code	Dia	Backplate	Finish
H3701304	19mm	165x45mm	Satin Stainless Steel
H3701303	19mm	165x45mm	Polished Stainless Steel



N&C Specifier Lever Lock Handle

- Safety lever lock handle on concealed fix long backplate
- Pierced for oval profile cylinder

Code	Dia	Backplate	Finish
H3701504	19mm	165x45mm	Satin Stainless Steel
H3701503	19mm	165x45mm	Polished Stainless Steel



N&C Specifier Lever Bathroom Handle

- Safety lever bathroom handle on concealed fix long backplate with external indicator/release & internal thumbturn

Code	Dia	Backplate	Finish
H3701404	19mm	165x45mm	Satin Stainless Steel
H3701403	19mm	165x45mm	Polished Stainless Steel



N&C Specifier Bathroom Indicator & Turn

- Bathroom indicator/release on round rose
- Internal thumbturn

Code	Dia	Finish
H3704404	50mm	Satin Stainless Steel
H3704403	50mm	Polished Stainless Steel



N&C Specifier Bathroom Indicator & Extended Turn

- Bathroom indicator/release on round rose
- Extended thumbturn

Code	Dia	Finish
H3704504	50mm	Satin Stainless Steel
H3704503	50mm	Polished Stainless Steel

Did you know?
Stainless Steel has hygienic properties. This means the cleanability of stainless steel makes it the first choice in hospitals, kitchens, pharmaceutical and food processing facilities.



N&C Contractor Standard Keyway Escutcheon

- Concealed fix escutcheon
- Standard keyway

Code	Dia	Finish
H3704104	50mm	Satin Stainless Steel
H3704103	50mm	Polished Stainless Steel



N&C Specifier Euro Profile Escutcheon

- Concealed fix escutcheon
- Euro profile cylinder

Code	Dia	Finish
H3704204	50mm	Satin Stainless Steel
H3704203	50mm	Polished Stainless Steel



N&C Specifier Oval Profile Escutcheon

- Concealed fix escutcheon
- Oval profile cylinder

Code	Dia	Finish
H3704304	50mm	Satin Stainless Steel
H3704303	50mm	Polished Stainless Steel



N&C Specifier Pull Handle

- Straight pull handle with bolt through fixings

Code	Size	Finish
H3706104	150x19mm	Satin Stainless Steel
H3706103	150x19mm	Polished Stainless Steel
H3706404	225x19mm	Satin Stainless Steel
H3706403	225x19mm	Polished Stainless Steel
H3706704	305x19mm	Satin Stainless Steel
H3706703	305x19mm	Polished Stainless Steel
H3706714	400x19mm	Satin Stainless Steel
H3706713	400x19mm	Polished Stainless Steel
H3706724	400x22mm	Satin Stainless Steel
H3706723	400x22mm	Polished Stainless Steel



N&C Specifier Pull Handle Rose

- Pair of roses to convert bolt fix pull handle to surface fix

Code	Dia	Finish
H3706804	50mm	Satin Stainless Steel
H3706803	50mm	Polished Stainless Steel



N&C Specifier Pull Handle

- Straight pull handle on backplate
- Screw fix

Code	Handle	Plate	Finish
H3706204	225x19mm	300x75mm	Satin Stainless Steel
H3706203	225x19mm	300x75mm	Polished Stainless Steel



N&C Specifier Finger Plate

- Plain finger plate with radius corners
- Drilled & countersunk

Code	Size	Finish
H0380505	305x64x1.5mm	Satin Stainless Steel
H0380506	305x76x1.5mm	Polished Stainless Steel
H0380605	330x76x1.5mm	Satin Stainless Steel
H0380606	330x76x1.5mm	Polished Stainless Steel

Other sizes made to order



N&C Specifier Finger Plate

- Engraved finger plate "push" with radius corners
- Drilled & countersunk

Code	Size	Finish
H0381012	305x76x1.5mm	Satin Stainless Steel
H0381006	305x76x1.5mm	Polished Stainless Steel



N&C Specifier Flush Bolt

- Lever action flush bolt

Code	Size	Finish
H0489201	150x19mm	Satin Stainless Steel
H0489202	200x19mm	Satin Stainless Steel

N&C Specifier Kicking Plate

- Kicking plate with square corners
- Drilled & countersunk

Code	Size	Finish
H0387001	675x152x1.5mm	Satin Stainless Steel
H0387701	675x152x1.5mm	Polished Stainless Steel
H0387011	750x152x1.5mm	Satin Stainless Steel
H0387711	750x152x1.5mm	Polished Stainless Steel
H0387021	825x152x1.5mm	Satin Stainless Steel
H0387721	825x152x1.5mm	Polished Stainless Steel

Other sizes made to order



N&C Specifier Wall Door Stop

- Wall mounted buffered door stop

Code	Projection	Finish
H3711904	75x16mm	Satin Stainless Steel
H3711903	75x16mm	Polished Stainless Steel



N&C Specifier Wall Door Stop on Rose

- Concealed fix wall mounted door stop on round rose

Code	Size	Finish
H3711004	75x16mm	Satin Stainless Steel
H3711003	75x16mm	Polished Stainless Steel



N&C Specifier Floor Door Stop

- Concealed fix floor mounted door stop

Code	Dia	Finish
H3712104	30mm	Satin Stainless Steel
H3712103	30mm	Polished Stainless Steel



N&C Sprung Letter Plate

- Sprung letter plate

Code	Size	Finish
H3709104	305x102mm	Satin Stainless Steel
H3709103	305x102mm	Polished Stainless Steel



N&C Specifier Buffered Hooks

- Strip pattern

	Code	Finish
Hat & Coat	H3714004	Satin Stainless Steel
Robe Hook	H3714104	Satin Stainless Steel
Hat & Coat	H3714003	Polished Stainless Steel
Robe Hook	H3714103	Polished Stainless Steel



N&C Specifier Cylinder Pull

- Cylinder pull euro profile cylinder
- Screw fix

Code	Finish
H3705004	Satin Stainless Steel
H3705003	Polished Stainless Steel

N&C Duo Range

An attractive, stainless steel range combining satin and polished finishes. The satin finish is designed to feature in the 'grip area' of handles to avoid the need for constant cleaning.

A range that is ideal for domestic projects, as well as the hospitality industry in hotels, bars, nightclubs.

A full range of matching accessories are available to complete the unified look.



N&C Duo Slimline Pull Handle

- Straight pull handle with bolt through fixings

Code	Size	Finish
H3812205	225mm	Duo Stainless Steel

- Straight Pull Handle Back to Back Fix

Code	Size	Finish
H3812305	225mm	Duo Stainless Steel



N&C Duo Wave Pull Handle

- Shaped pull handle with bolt through fixings

Code	Size	Finish
H3812005	225mm	Duo Stainless Steel

- Shaped Pull Handle Back to Back Fix

Code	Size	Finish
H3812105	225mm	Duo Stainless Steel



N&C Duo Cressida Lever Handle

- Swept lever handle on concealed fix round rose

Code	Finish
H3800305	Duo Stainless Steel



N&C Duo Montana Lever Handle

- Flat curved lever handle on concealed fix round rose

Code	Finish
H3800306	Duo Stainless Steel



N&C Duo Valeria Lever Handle

- Contemporary lever handle on concealed fix round rose

Code	Finish
H3800307	Duo Stainless Steel



N&C Duo Bathroom Indicator/Release Escutcheon

- Bathroom indicator/release
- Round rose with internal thumbturn

Code	Finish
H3804405	Duo Stainless Steel



N&C Duo Standard Keyway Escutcheon

- Concealed fix escutcheon
- Standard keyway

Code	Finish
H3804104	Duo Stainless Steel



N&C Duo Euro Profile Escutcheon

- Concealed fix escutcheon
- Euro profile cylinder

Code	Finish
H3804205	Duo Stainless Steel



N&C Duo Bathroom Extended Turn & Indicator

- Bathroom indicator/release
- Round rose with internal thumbturn

Code	Finish
H3804605	Duo Stainless Steel



N&C Innovations Range

A stylish range of door furniture manufactured in a variety of metals with various electro plated durable finishes. Matching accessories are available to complete a unified look. Ideal for residential and other domestic projects.



N&C Palomon Lever Handle

- Swept lever handle on concealed fix round rose

Code	Finish
H8006002	Polished Chrome
H8006003	Satin Chrome
H8006001	Polished Brass



N&C Angelo Lever Handle

- Swept lever handle on concealed fix round rose

Code	Finish
H8003002	Polished Chrome
H8003003	Satin Chrome
H8003001	Polished Brass



N&C Camillo Lever Handle

- Curved lever handle on concealed fix round rose

Code	Finish
H8004002	Polished Chrome
H8004003	Satin Chrome
H8004001	Polished Brass

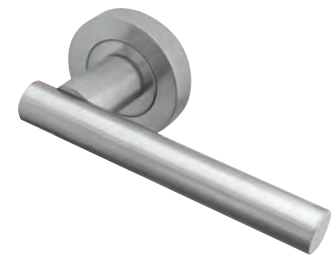

N&C Lucio Lever Handle

- Straight tee lever handle on concealed fix round rose

Code	Finish
H8005002	Polished Chrome
H8005003	Satin Chrome
H8005001	Polished Brass



N&C Bathroom Indicators

- Bathroom indicator/release on round rose
- Internal thumbturn
- To match Angelo, Camillo, Lucio & Palamon lever handles

Code	Finish
H8030302	Polished Chrome
H8030303	Satin Chrome
H8030301	Polished Brass



N&C Standard Keyway Escutcheons

- Concealed fix escutcheon
- Standard keyway
- To match Angelo, Camillo, Lucio and Palamon lever handles

Code	Finish
H8030002	Polished Chrome
H8030003	Satin Chrome
H8030001	Polished Brass



N&C Euro Profile Escutcheons

- Concealed fix escutcheon
- Euro profile cylinder
- To match Angelo, Camillo, Lucio and Palamon lever handles

Code	Finish
H8030102	Polished Chrome
H8030103	Satin Chrome
H8030102	Polished Brass

A collection of attractive, luxury door furniture in contemporary designs finished in polished and satin chrome for a striking appeal.

Perfect for any commercial and domestic project.



N&C Athena Lever Handle

- Shaped lever handle on concealed fix square rose

Code	Finish
H8009033	Polished Chrome
H8009034	Satin Chrome



N&C Peligia Lever Handle

- Shaped lever handle on concealed fix square rose

Code	Finish
H8009073	Polished Chrome
H8009074	Satin Chrome



N&C Bathroom Indicator/Release

- Bathroom indicator/release on square rose
- Internal thumbturn
- To match Athena & Peligia lever handles

Code	Finish
H8040953	Polished Chrome
H8040954	Satin Chrome



N&C Standard Keyway Escutcheons

- Concealed fix escutcheon
- Standard keyway
- To match Athena & Peligia lever handles

Code	Finish
H8040933	Polished Chrome
H8040934	Satin Chrome



N&C Euro Profile Escutcheons

- Concealed fix escutcheon
- Euro profile cylinder
- To match Athena & Peligia lever handles

Code	Finish
H8040943	Polished Chrome
H8040944	Satin Chrome



N&C Callia Lever Handle

- Shaped lever handle on concealed fix round rose

Code	Finish
H8009054	Polished Chrome
H8009064	Satin Chrome



N&C Neola Lever Handle

- Shaped lever handle on concealed fix round rose

Code	Finish
H8009064	Polished & Satin Chrome



N&C Voleta Lever Handle

- Shaped lever handle on concealed fix round rose

Code	Finish
H8009001	Polished & Satin Chrome



N&C Bathroom Indicator/Release

- Bathroom indicator/release on round rose
- Internal thumbturn
- To match Callia, Neola & Voleta lever handles

Code	Finish
H8041204	Polished & Satin Chrome



N&C Standard Keyway Escutcheons

- Concealed Fix Escutcheon
- Standard Keyway
- To match Callia, Neola & Voleta lever handles

Code	Finish
H8049004	Polished & Satin Chrome



N&C Euro Profile Escutcheons

- Concealed Fix Escutcheon
- Euro Profile Cylinder
- To match Callia, Neola & Voleta lever handles

Code	Finish
H8041004	Polished & Satin Chrome

N&C Perdita Lever Handle

- Straight Tee lever handle on concealed fix round rose
- Ideal for domestic projects or luxury offices
- attractive, contemporary choice

Code	Finish
H3800204	Satin Stainless Steel
H3800203	Polished Stainless Steel



N&C Soliano Lever Handle

- Curved lever handle on concealed fix round rose

Code	Finish
H3800304	Satin Stainless Steel
H3800303	Polished Stainless Steel



N&C Cronus Lever Handle

- Mitred lever handle on concealed fix round rose

Code	Finish
H3800004	Satin Stainless Steel
H3800003	Polished Stainless Steel



N&C Nessus Lever Handle

- Straight Tee lever handle on concealed fix round rose

Code	Finish
H3800104	Satin Stainless Steel
H3800103	Polished Stainless Steel



N&C Bathroom Indicator/Release

- Bathroom indicator/release on round rose
- Internal thumbturn
- To match Perdita, Soliano, Cronos & Nessus Lever Handles

Code	Finish
H3704404	Satin Stainless Steel
H3704403	Polished Stainless Steel



N&C Standard Keyway Escutcheons

- Concealed Fix Escutcheon
- Standard Keyway
- To match Perdita, Soliano, Cronos & Nessus Lever Handles

Code	Finish
H3804104	Satin Stainless Steel
H3804103	Polished Stainless Steel



N&C Euro Profile Escutcheons

- Concealed Fix Escutcheon
- Euro Profile Cylinder
- To match Perdita, Soliano, Cronos & Nessus Lever Handles

Code	Finish
H3804204	Satin Stainless Steel
H3804203	Polished Stainless Steel



Ask the
EXPERT

Our team of ironmongery specialists are on hand to help you with your project requirements.



N&C Carisbrooke Lever Handle

- Curved lever handle on concealed fix round rose

Code	Dia	Finish
H3806833	52mm	Polished Chrome
H3806834	52mm	Satin Chrome
H3806835	52mm	Polished & Satin Chrome



N&C Alnwick Lever Handle

- Contemporary lever handle on concealed fix round rose

Code	Dia	Finish
H3806836	52mm	Polished & Satin Chrome



N&C Hadleigh Lever Handle

- Straight tee lever handle on concealed fix round rose

Code	Dia	Finish
H3806837	52mm	Polished Chrome
H3806838	52mm	Satin Chrome



N&C Warwick Lever Handle

- Contemporary lever handle on concealed fix round rose

Code	Dia	Finish
H3806848	52mm	Polished & Satin Chrome



N&C Richmond Lever Handle

- Flat curved lever handle on concealed fix round rose

Code	Dia	Finish
H3806849	52mm	Polished & Satin Chrome



N&C Portland Lever Handle

- Stepped lever handle on concealed fix round rose

Code	Dia	Finish
H3806850	52mm	Polished & Satin Chrome



N&C Bathroom Indicator/Release

- Bathroom indicator/release on round rose
- Internal thumbturn
- To match Carisbrooke, Alnwick, Hadleigh, Warwick, Richmond and Portland lever handles

Code	Dia	Finish
H3806842	52mm	Polished Chrome
H3806843	52mm	Satin Chrome
H3806844	52mm	Polished & Satin Chrome



N&C Standard Keyway Escutcheons

- Concealed fix escutcheon
- Standard keyway
- To match Carisbrooke, Alnwick, Hadleigh, Warwick, Richmond and Portland lever handles

Code	Dia	Finish
H3806845	52mm	Polished Chrome
H3806846	52mm	Satin Chrome
H3806847	52mm	Polished & Satin Chrome



N&C Euro Profile Escutcheons

- Concealed fix escutcheon
- Euro profile cylinder
- To match Carisbrooke, Alnwick, Hadleigh, Warwick, Richmond and Portland lever handles

Code	Dia	Finish
H3806839	52mm	Polished Chrome
H3806840	52mm	Satin Chrome
H3806841	52mm	Polished & Satin Chrome



N&C Cambridge Lever Handle

- Contemporary lever handle on concealed fix round rose

Code	Dia	Finish
H3806854	52mm	Polished Nickel - Gold Effect Grip
H3806855	52mm	Polished Nickel - Silver Effect Grip
H3806856	52mm	Polished Nickel - Black Effect Grip



N&C Strand Lever Handle

- Straight lever handle on concealed fix round rose

Code	Dia	Finish
H3806857	52mm	Polished Nickel
H3806858	52mm	Satin Nickel



N&C Como Lever Handle

- Swept lever handle on concealed fix round rose

Code	Dia	Finish
H3806859	52mm	Polished Nickel



N&C Belgravia Lever Handle

- Swept lever handle on concealed fix round rose

Code	Dia	Finish
H3806861	52mm	Ebony



N&C Oxford Lever Handle

- Curved lever handle on concealed fix round rose

Code	Dia	Finish
H3806862	52mm	Ebony



N&C Serpentine Lever Handle

- Swept lever handle on concealed fix round rose

Code	Dia	Finish
H3806863	52mm	Ebony



N&C Regent Lever Handle

- Safety lever handle on concealed fix round rose

Code	Dia	Finish
H3806864	52mm	Ebony



N&C Windsor Lever Handle

- Safety lever handle on concealed fix round rose

Code	Dia	Finish
H3806860	52mm	Satin Nickel



N&C Bathroom Indicator/Release

- Bathroom Indicator/Release On Round Rose
- Internal Thumbturn
- To match Cambridge, Strand, Como, Belgravia, Oxford, Serpentine, Regent, and Windsor lever handle

Code	Dia	Finish
H3812009	52mm	Polished Nickel
H3812010	52mm	Satin Nickel
H3812012	52mm	Ebony



N&C Standard Keyway Escutcheons

- Concealed Fix Escutcheon
- Standard Keyway
- To match Cambridge, Strand, Como, Belgravia, Oxford, Serpentine, Regent, and Windsor lever handle

Code	Dia	Finish
H3812001	52mm	Polished Nickel
H3812002	52mm	Satin Nickel
H3812004	52mm	Ebony



N&C Euro Profile Escutcheons

- Concealed Fix Escutcheon
- Euro Profile Cylinder
- To match Cambridge, Strand, Como, Belgravia, Oxford, Serpentine, Regent, and Windsor lever handle

Code	Dia	Finish
H3812003	52mm	Polished Nickel
H3812006	52mm	Satin Nickel
H3812008	52mm	Ebony



N&C Sandrine Lever Handle

• Curved lever handle on concealed fix round rose

Code	Dia	Finish
H3700013	50mm	Polished Stainless Steel
H3700014	50mm	Satin Stainless Steel



N&C Monza Lever Handle

• Swept lever handle on concealed fix round rose

Code	Dia	Finish
H9910258	50mm	Satin Stainless Steel



N&C Salerno Lever Handle

• Swept T lever handle on concealed fix round rose

Code	Dia	Finish
H9910259	50mm	Satin Stainless Steel



N&C Selini Lever Handle

• Curved lever handle on concealed fix round rose

Code	Dia	Finish
H8009004	50mm	Polished & Satin Nickel



N&C Messina Lever Handle

• Contemporary lever handle on concealed fix round rose

Code	Dia	Finish
H9910260	50mm	Satin Stainless Steel



N&C Trento Lever Handle

• Straight lever handle on concealed fix round rose

Code	Dia	Finish
H9910261	50mm	Satin Stainless Steel



N&C Terni Lever Handle

• Stepped lever handle on concealed fix round rose

Code	Dia	Finish
H9910262	50mm	Satin Stainless Steel



N&C Sapphira Lever Handle

• Swept lever handle on concealed fix round rose

Code	Dia	Finish
H8009043	50mm	Polished Chrome
H8009044	50mm	Satin Chrome



N&C Calisto Lever Handle

• Stepped lever Handle on Concealed Fix Round Rose

Code	Dia	Finish
H8009014	50mm	Polished Chrome/Nickel



N&C Kyria Lever Handle

• Stepped lever Handle on Concealed Fix Round Rose

Code	Dia	Finish
H8009024	50mm	Polished Chrome/Nickel



N&C Victorian Range

A traditional range manufactured in solid brass for durability, quality and aesthetics. The Victorian range is available in polished and lacquered brass as well as polished and satin chrome finishes.

A range that is ideal for residential projects. A huge range of matching accessories are available.



N&C Victorian Straight Lever Latch Handle

- Straight lever latch handle on round rose

Code	Rose	Finish
H8000003	50mm	Polished Brass



N&C Victorian Straight Lever Latch Handle

- Straight lever latch handle on short backplate

Code	Backplate	Finish
H8000002	112x40mm	Polished Brass



N&C Victorian Straight Lever Latch Handle

- Straight lever latch handle on long backplate

Code	Backplate	Finish
H8000006	150x40mm	Polished Brass



N&C Victorian Straight Lever Lock Handle

- Straight lever lock handle standard keyway

Code	Backplate	Finish
H8000001	150x40mm	Polished Brass



N&C Victorian Straight Lever Bathroom Handle

- Straight lever bathroom handle
- Backplate with turn & release

Code	Backplate	Finish
H8000004	150x40mm	Polished Brass



N&C Victorian Straight Lever Privacy Handle

- Straight lever privacy handle
- Backplate with turn & release

Code	Backplate	Finish
H8000005	112x40mm	Polished Brass



N&C Victorian Scroll Lever Latch Handle

- Scroll lever latch handle on round rose

Code	Rose	Finish
H8000013	50mm	Polished Brass



N&C Victorian Scroll Lever Latch Handle

- Scroll lever latch handle short backplate

Code	Backplate	Finish
H8000012	112x40mm	Polished Brass



N&C Victorian Scroll Lever Latch Handle

- Scroll lever latch handle long backplate

Code	Backplate	Finish
H8000016	150x40mm	Polished Brass



N&C Victorian Scroll Lever Lock Handle

- Scroll lever lock handle • Standard keyway

Code	Backplate	Finish
H8000011	150x40mm	Polished Brass



N&C Victorian Scroll Lever Bathroom Handle

- Scroll lever bathroom handle
- Backplate with turn & release

Code	Backplate	Finish
H8000014	150x40mm	Polished Brass



N&C Victorian Scroll Lever Privacy Handle

- Straight lever privacy handle
- Backplate with turn & release

Code	Backplate	Finish
H8000015	112x40mm	Polished Brass



N&C Epsom Victorian Scroll Lever Latch Handle

- Scroll lever latch handle • Shaped backplate

Code	Backplate	Finish
H8000018	170x40mm	Polished Brass



N&C Epsom Victorian Scroll Lever Lock Handle

- Scroll lever lock handle • Standard keyway
- Shaped backplate

Code	Backplate	Finish
H8000017	170x40mm	Polished Brass



N&C Epsom Victorian Scroll Lever Bathroom Handle

- Scroll lever bathroom handle
- Backplate with turn & release • Shaped backplate

Code	Backplate	Finish
H8000019	170x40mm	Polished Brass



N&C Pull Handle on Plate

- Straight pull handle on plate

Code	Handle	Plate	Finish
H8000088	225mm	305x63mm	Polished Brass
H8000087	305mm	375x63mm	Polished Brass



N&C Pull Handle

- Straight pull handle bolt through fix

Code	Handle	Finish
H8000101	225mm	Polished Brass
H8000102	305mm	Polished Brass



N&C Pull Handle on Rose

- Straight pull handle on concealed fix round rose

Code	Rose	Finish
H8000097	225mm	Polished Brass
H8000098	300mm	Polished Brass



N&C Straight Pull Handle on Pillars

- Straight pull handle on pillars • Concealed fix round roses

Code	Handle	Finish
H8000088	225mm	Polished Brass



N&C Cranked Pull Handle

- Cranked pull handle face fix

Code	Rose	Finish
H8000093	225mm	Polished Brass
H8000094	300mm	Polished Brass



N&C Offset Pull Handle

- Offset pull handle on face fix rectangular plates

Code	Rose	Finish
H8000089	152mm	Polished Brass
H8000090	200mm	Polished Brass
H8000091	250mm	Polished Brass
H8000092	300mm	Polished Brass



N&C Mushroom Mortice Knob

- Mortice knob handle on round rose

Code	Dia	Finish
H8000064	50mm	Polished Brass
H8000065	57mm	Polished Brass
H8000066	64mm	Polished Brass



N&C Oval Mortice Knob

- Mortice knob handle on round rose

Code	Dia	Finish
H8000067	60mm	Polished Brass



N&C Ball Mortice Knob

- Mortice knob handle on round rose

Code	Dia	Finish
H8001069	32mm	Polished Brass



N&C Regency Cabin Hook

- Silent pattern cabin hook & eye

Code	Size	Finish
H8000153	75mm	Polished Brass
H8000154	102mm	Polished Brass
H8000155	152mm	Polished Brass
H8000156	200mm	Polished Brass
H8000157	250mm	Polished Brass
H8000158	300mm	Polished Brass



N&C Straight French Window Door Bolt

Code	Size	Finish
H8000136	200mm	Polished Brass
H8000137	250mm	Polished Brass



N&C Straight Bell Pattern Barrel Bolt

Code	Size	Finish
H8000138	100x32mm	Polished Brass
H8000139	150x32mm	Polished Brass

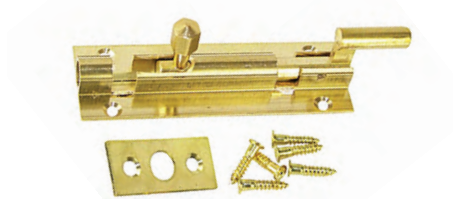

N&C Necked Pattern Barrel Bolt

Code	Size	Finish
H8000140	100x32mm	Polished Brass
H8000141	150x32mm	Polished Brass



N&C Straight Vertical Ball End Bolt

Code	Size	Finish
H8000142	250mm	Polished Brass
H8000143	300mm	Polished Brass
H8000144	350mm	Polished Brass
H8000145	400mm	Polished Brass
H8000146	500mm	Polished Brass
H8000147	600mm	Polished Brass



N&C Straight Flat Section Bolt

- Straight flat section bolt

Code	Size	Finish
H8000048	150mm	Polished Brass
H8000049	200mm	Polished Brass



N&C Bathroom Indicator Bolt Set

- Bathroom oval turn knob & release
- Round rose with mortice bolt

Code	Dia	Finish
H8000052	32mm	Polished Brass



N&C Bathroom Turn Knob

- Bathroom oval turn knob on round rose spined spindle

Code	Dia	Finish
H8000053	32mm	Polished Brass



N&C Bathroom Turn Knob & Realse

- Bathroom oval turn knob & release
- 5mm square spindle

Code	Dia	Finish
H8000056	32mm	Polished Brass



N&C Mortice Security Bolt

- Splined follower

Code	Backset	Finish
H8000054	28mm	Polished Brass



N&C Bathroom Turn Knob

- Bathroom oval turn knob on oval rose

Code	backset	Finish
H8000148	28mm	Polished Brass



N&C Bathroom Indicator Bolt Set

- Bathroom slide indicator bolt
- Vacant/engaged indicator
- Emergency release

Code	Size	Finish
H8000167	60x40mm	Polished Brass



N&C Door Holder

- Surface fix sprung door holder (Not for use on fire rated doors)

Code	Size	Finish
H8000162	180mm	Polished Brass



N&C Projection Door Stop

- "Spring" projection door stop with rubber buffer

Code	Size	Finish
H8000059	75mm	Polished Brass



N&C Projection Door Stop

- Projection door stop on round rose with rubber buffer

Code	Size	Finish
H8000160	64mm	Polished Brass
H8000057	75mm	Polished Brass



N&C Floor Door Stop

- Circular floor door stop with shield & rubber buffer

Code	Size	Finish
H8000161	40x30mm	Polished Brass

Recommended Care of Finishes

Brass lacquered

When brass is lacquer coated to preserve the original polish, regular dusting of internal fittings with the occasional application of a light coating of wax polish will prolong the life of the lacquer. Ultimately the lacquer will become damaged and break down. Should this occur, all traces of the lacquer should be removed using acetate lacquer remover. The product may then be re-lacquered or cleaned as unlacquered brass on a regular basis. For products fitted in exposed conditions we recommend the application of wax polish once a week. If lacquered surface is to be prolonged, avoid the use of brass cleaners or chemical based sprays.

Do not use a metal cleaner or aerosol spray to clean brass products.



N&C Victorian Straight Lever Latch Handle

- Straight lever latch handle round rose

Code	Rose	Finish
H8001003	50mm	Polished Chrome



N&C Victorian Straight Lever Latch Handle

- Straight lever latch handle short backplate

Code	Backplate	Finish
H8001002	112x40mm	Polished Chrome



N&C Victorian Straight Lever Lock Handle

- Straight lever lock handle standard keyway

Code	Backplate	Finish
H8001001	150x40mm	Polished Chrome



N&C Victorian Straight Bathroom Lever Handle

- Straight lever bathroom handle
- Backplate with turn & release

Code	Backplate	Finish
H8001004	112x40mm	Polished Chrome



N&C Victorian Straight Lever Privacy Handle

- Straight lever privacy handle
- Backplate with turn & release

Code	Backplate	Finish
H8001005	112x40mm	Polished Chrome



N&C Epsom Victorian Scroll Lever Latch Handle

- Scroll handle on shaped backplate

Code	Backplate	Finish
H8001018	170x40mm	Polished Chrome



N&C Epsom Victorian Scroll Lever Lock Handle

- Scroll handle on shaped backplate
- Standard keyway

Code	Backplate	Finish
H8001017	170x40mm	Polished Chrome



N&C Epsom Victorian Scroll Lever Bathroom Handle

- Scroll handle on shaped backplate with turn & release

Code	Backplate	Finish
H8001019	170x40mm	Polished Chrome



N&C Victorian Scroll Lever Latch Handle

- Scroll lever latch handle on round rose

Code	Rose	Finish
H8001180	50mm	Polished Chrome



N&C Victorian Scroll Lever Latch Handle

- Scroll lever latch handle on short backplate

Code	Backplate	Finish
H8001012	112x40mm	Polished Chrome



N&C Victorian Scroll Lever Lock Handle

- Scroll lever lock handle • Standard keyway

Code	Backplate	Finish
H8001011	150x40mm	Polished Chrome



N&C Victorian Scroll Bathroom Lever Handle

- Scroll lever bathroom handle
- Backplate with turn & release

Code	Backplate	Finish
H8001014	112x40mm	Polished Chrome



N&C Victorian Scroll Lever Privacy Handle

- Scroll Lever privacy handle
- Backplate with turn & release

Code	Backplate	Finish
H8001015	112x40mm	Polished Chrome

Recommended Care of Finishes

Polish chrome products are virtually maintenance free, however deposits will accumulate especially on external fittings.

We recommend regular cleaning with a soft cloth and non abrasive wax polish. This will help to maintain the original appearance.

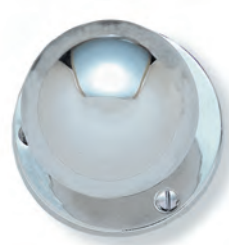

N&C Ball Mortice Knob

- Ball mortice knob handle on round rose

Code	Dia	Finish
H8001006	50mm	Polished Chrome



N&C Mushroom Mortice Knob

- Mushroom mortice knob handle on round rose

Code	Dia	Finish
H8001007	57mm	Polished Chrome



N&C Oval Mortice Knob

- Oval mortice knob on round rose

Code	Dia	Finish
H8001008	60mm	Polished Chrome

N&C Antque Range

A range of traditional iron fittings for authentic old England style door furniture. Perfect for old cottages, period style buildings, or to simply adopt the old vintage look.

Our Antique range features an antique black finish, particularly suitable for period properties.

A complete range of matching accessories is available.



N&C Antique Curved Lever Lock Handle

- Regal curved lever lock handle on rectangular backplate

Code	Size	Finish
H8070001	150x50mm	Antique Black



N&C Antique Curved Lever Latch Handle

- Curved lever latch handle on rectangular backplate

Code	Size	Finish
H8070003	155x52mm	Antique Black



N&C Antique Curved Lever Latch Handle

- Curved lever latch handle on Short rectangular backplate

Code	Size	Finish
H8070002	110x50mm	Antique Black



N&C Antique Curved Bathroom Handle

- Regal curved lever latch handle on rectangular backplate
- Turn & emergency release

Code	Size	Finish
H8070004	155x52mm	Antique Black



N&C Fleur De Lys Scroll Lever Lock Handle

- Lever lock handle on shaped backplate
- Standard keyway

Code	Size	Finish
H8070012	195x54mm	Antique Black



N&C Fleur De Lys Scroll Lever Latch Handle

- Lever lock handle on shaped backplate

Code	Size	Finish
H8070011	195x54mm	Antique Black



N&C Fleur De Lys Straight Pull Handle

- Fleur de lys straight pull handle

Code	Size	Finish
H8070031	155x52mm	Antique Black



N&C Cabin Hook

- Ring pattern cabin hook

Code	Size	Finish
H8070080	102mm	Antique Black
H8070061	152mm	Antique Black



N&C Indicator Bolt

- Circular external "vacant/engaged" indicator
- Emergency release with internal "lift" bolt

Code	Dia	Finish
H8070050	70mm	Antique Black



N&C Hat & Coat Hook

- Traditional straight pattern hat & coat hook

Code	Size	Finish
H8070052	125mm	Antique Black



N&C Single Robe Hook

- Traditional single robe hook

Code	Size	Finish
H8070054	55mm	Antique Black



N&C Double Robe Hook

- Traditional double robe hook

Code	Size	Finish
H8070055	195x54mm	Antique Black

Recommended Care of Finishes

Iron is vulnerable to rusting. Where abrasive areas of moving parts are evident, an occasional light oiling is recommended.

To remove harmful deposits which will cause corrosion, we advise regular wiping of the product with a lightly oiled cloth.

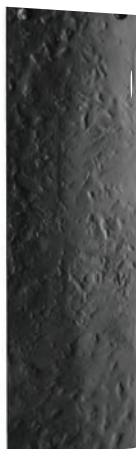

N&C Finger Plate

- Rectangular finger plate

Code	Size	Finish
H8070032	300x76mm	Antique Black



N&C Straight Bolt

- Straight slide pattern bolt

Code	Size	Finish
H8070041	200mm	Antique Black



N&C Necked Bolt

- Necked slide pattern bolt

Code	Size	Finish
H8070040	200mm	Antique Black

N&C Urban Door Furniture

A range that includes aluminium furniture that is perfect for local authority/void works or other projects where cost and function is of importance.

This is also available in 'Door packs' which makes for easier management of product on larger construction sites

The door packs are also available with 2 victorian styles of lever handles in polished brass, polished chrome and satin chrome finishes



N&C Urban Straight Lever Latch Handle

- Straight lever latch handle on backplate
- Silver anodised aluminium

Code	Rose	Finish
H8900003	104x40mm	Satin Anodised Aluminium



N&C Urban Straight Lever Lock Handle

- Straight lever lock handle on backplate
- Silver anodised aluminium

Code	Rose	Finish
H8901003	153x40mm	Satin Anodised Aluminium



N&C Urban Straight Lever Bathroom Handle

- Straight lever bathroom handle on backplate
- Silver anodised aluminium

Code	Rose	Finish
H8901403	153x40mm	Satin Anodised Aluminium



Latch Pack

N&C Urban Mortice Latch Pack BB

- Lever latch furniture
- 76mm tubular mortice latch
- 76mm stainless steel ball bearing butt hinges x2

Code	Finish
H7908001	Satin Anodised Aluminium



Lock Pack

N&C Urban Mortice Lock Pack BB

- Lever lock furniture
- 76mm 3 lever mortice sashlock
- 100mm stainless steel ball bearing butt hinges x2

Code	Finish
H7908002	Satin Anodised Aluminium



Bathroom Pack

N&C Urban Mortice Bathroom Pack BB

- Lever Bathroom turn/release
- 76mm mortice bathroom lock
- 76mm stainless steel ball bearing butt hinges x2

Code	Finish
H7908003	Satin Anodised Aluminium



Latch Pack

N&C Urban Mortice Latch Pack

- Lever latch furniture • 63mm Tubular Mortice Latch
- 76mm BZP light pattern steel butt hinges x2

Code	Finish
H7910002	Satin Anodised Aluminium



Lock Pack

N&C Urban Mortice Lock Pack

- lever lock furniture • 63mm 3 lever mortice sashlock
- 76mm BZP light pattern steel butt hinges x2

Code	Finish
H7910001	Satin Anodised Aluminium



Bathroom Pack

N&C Urban Mortice Bathroom Pack

- Lever Bathroom turn/release • 76mm mortice bathroom lock
- 76mm BZP light pattern steel butt hinges x2

Code	Finish
H7910003	Satin Anodised Aluminium



Latch Pack

N&C Victorian Straight Mortice Latch Pack

- Lever latch furniture • 63mm tubular mortice latch
- 76mm light pattern steel butt hinges x2

Code	Finish
H7920002	Polished Brass
H7930002	Polished Chrome
H7940002	Satin Chrome



Lock Pack

N&C Victorian Straight Mortice Lock Pack

- Lever lock furniture • 65mm 3 lever mortice sashlock
- 76mm light pattern steel butt hinges x2

Code	Finish
H7920001	Polished Brass
H7930001	Polished Chrome
H7940001	Satin Chrome



Privacy Pack

N&C Victorian Straight Privacy Pack

- Victorian straight privacy furniture with turn/release
- 65mm tubular mortice latch
- 76mm light pattern steel butt hinges x2

Code	Finish
H7920004	Polished Brass
H7930004	Polished Chrome



Latch Pack

N&C Victorian Scroll Mortice Latch Pack

- Scroll lever latch furniture • 63mm tubular mortice latch
- 76mm light pattern steel butt hinges x2

Code	Finish
H7920012	Polished Brass
H7930012	Polished Chrome
H7940012	Satin Chrome



Lock Pack

N&C Victorian Scroll Mortice Lock Pack

- Scroll lever lock furniture • 65mm 3 lever mortice sashlock
- 76mm light pattern steel butt hinges x2

Code	Finish
H7920011	Polished Brass
H7930011	Polished Chrome
H7940011	Satin Chrome



Privacy Pack

N&C Victorian Scroll Mortice Privacy Pack

- Scroll privacy furniture with turn/release
- 65mm tubular mortice latch
- 76mm light pattern steel butt hinges x2

Code	Finish
H7920014	Polished Brass
H7930014	Polished Chrome



Victorian Letter Plate with Pull Handle

- Victorian pattern sprung letter plate

Code	Overall	Aperture	Centres	Finish
H8000080	250x102mm	180x45mm	210mm	Polished Brass



Victorian Letter Plate

- Victorian pattern sprung letter plate

Code	Overall	Aperture	Centres	Finish
H8000027	254x100mm	206x50mm	232mm	Polished Brass
H8000077	280x90mm	280x90mm	240mm	Polished Brass
H8000028	305x100mm	234x57mm	270mm	Polished Brass
H8000078	355x155mm	283x63mm	322mm	Polished Brass
H8001025	254x100mm	206x50mm	232mm	Polished Chrome
H8001080	280x90mm	280x90mm	240mm	Polished Chrome
H7001026	305x100mm	234x57mm	270mm	Polished Chrome
H8001081	355x155mm	283x63mm	322mm	Polished Chrome
H8002021	254x100mm	206x50mm	232mm	Satin Chrome
H8002069	280x90mm	280x90mm	240mm	Satin Chrome
H8002022	305x100mm	234x57mm	270mm	Satin Chrome
H8002070	355x155mm	283x63mm	322mm	Satin Chrome
H8070024	260x80mm	190x40mm	220mm	Antique Black
H8070027	270x115mm	190x43mm	230mm	Antique Black



Victorian Gravity Letter Plate

- Victorian pattern sprung letter plate
- Outward opening

Code	Overall	Aperture	Centres	Finish
H8000081	254x102mm	204x42mm	230mm	Polished Brass



Interior Letter Tidy

- Interior letter tidy

Code	Overall	Finish
H8000029	280x80mm	Polished Brass
H8000030	297x85mm	Polished Brass
H8000084	352x127mm	Polished Brass
H8000085	400x127mm	Polished Brass
H7001027	280x80mm	Polished Chrome
H7001028	297x85mm	Polished Chrome
H7001029	352x127mm	Polished Chrome
H7001100	400x127mm	Polished Chrome
H7002039	280x80mm	Satin Chrome
H7002041	297x85mm	Satin Chrome
H7002042	352x127mm	Satin Chrome
H7002043	400x127mm	Satin Chrome
H8070028	308x85mm	Antique Black

Postal Knocker

- Sprung postal knocker

Code	Overall	Aperture	Centres	Finish
H8000025	250x76mm	190x40mm	215mm	Polished Brass
H8001024	250x76mm	190x40mm	215mm	Polished Chrome
H8002073	250x76mm	190x40mm	215mm	Satin Chrome
H8070025	310x105mm	200x45mm	258mm	Antique Black



Door Letters

● Pin fixing ● 50mm

Letter	Code	Finish	Letter	Code	Finish
A	H8012200	Polished Brass	E	H8012204	Polished Brass
B	H8012201	Polished Brass	F	H8012205	Polished Brass
C	H8012202	Polished Brass	G	H8012206	Polished Brass
D	H8012203	Polished Brass	H	H8012207	Polished Brass

Door Numerals

● Screw fixing ● 75mm



Number	Code	Finish
Zero	H8012000	Polished Brass
One	H8012001	Polished Brass
Two	H8012002	Polished Brass
Three	H8012003	Polished Brass
Four	H8012004	Polished Brass
Five	H8012005	Polished Brass
Six	H8012006	Polished Brass
Seven	H8012007	Polished Brass
Eight	H8012008	Polished Brass
Nine	H8012009	Polished Brass



Door Numerals

● Screw fixing ● 75mm

Number	Code	Finish
Zero	H8002080	Satin Chrome
One	H8002081	Satin Chrome
Two	H8002082	Satin Chrome
Three	H8002083	Satin Chrome
Four	H8002084	Satin Chrome
Five	H8002085	Satin Chrome
Six	H8002086	Satin Chrome
Seven	H8002087	Satin Chrome
Eight	H8002088	Satin Chrome
Nine	H8002089	Satin Chrome

Door Numerals

● Pin fixing ● 75mm



Number	Code	Finish
Zero	H8022000	Polished Chrome
One	H8022001	Polished Chrome
Two	H8022002	Polished Chrome
Three	H8022003	Polished Chrome
Four	H8022004	Polished Chrome
Five	H8022005	Polished Chrome
Six	H8022006	Polished Chrome
Seven	H8022007	Polished Chrome
Eight	H8022008	Polished Chrome
Nine	H8022009	Polished Chrome



Door Numerals

● Screw fixing ● 100mm

Number	Code	Finish
Zero	H8071000	Antique Black
One	H8071001	Antique Black
Two	H8071002	Antique Black
Three	H8071003	Antique Black
Four	H8071004	Antique Black
Five	H8071005	Antique Black
Six	H8071006	Antique Black
Seven	H8071007	Antique Black
Eight	H8071008	Antique Black
Nine	H8071009	Antique Black

Door Numerals

● Pin fixing ● 60mm



Number	Code	Finish
Zero	H8012100	Polished Brass
One	H8012101	Polished Brass
Two	H8012102	Polished Brass
Three	H8012103	Polished Brass
Four	H8012104	Polished Brass
Five	H8012105	Polished Brass
Six	H8012106	Polished Brass
Seven	H8012107	Polished Brass
Eight	H8012108	Polished Brass
Nine	H8012109	Polished Brass



Door Numerals

● Pin fixing ● 60mm

Number	Code	Finish
Zero	H8022100	Polished Chrome
One	H8022101	Polished Chrome
Two	H8022102	Polished Chrome
Three	H8022103	Polished Chrome
Four	H8022104	Polished Chrome
Five	H8022105	Polished Chrome
Six	H8022106	Polished Chrome
Seven	H8022107	Polished Chrome
Eight	H8022108	Polished Chrome
Nine	H8022109	Polished Chrome

Door Numerals

● Pin fixing ● 60mm



Number	Code	Finish
Zero	H8002090	Satin Chrome
One	H8002091	Satin Chrome
Two	H8002092	Satin Chrome
Three	H8002093	Satin Chrome
Four	H8002094	Satin Chrome
Five	H8002095	Satin Chrome
Six	H8002096	Satin Chrome
Seven	H8002097	Satin Chrome
Eight	H8002098	Satin Chrome
Nine	H8002099	Satin Chrome





Ring Door Knocker

● Rear bolt fix

Code	Dia	Finish
H8000020	105mm	Polished Brass
H8001020	105mm	Polished Chrome
H8002110	105mm	Satin Chrome
H8070029	95mm	Antique Black



Scroll Door Knocker

● Rear bolt fix

Code	Dia	Finish
H8000074	135mm	Polished Brass
H8022050	135mm	Polished Chrome
H7002050	135mm	Satin Chrome



Contemporary Door Knocker

● Rear bolt fix

Code	Dia	Finish
H8000021	1575mm	Polished Brass
H8022052	157mm	Polished Chrome
H7002052	157mm	Satin Chrome



Small Urn Door Knocker

● Rear bolt fix

Code	Dia	Finish
H8000073	150mm	Polished Brass
H8022054	150mm	Polished Chrome
H7002054	150mm	Satin Chrome



Lion Head Door Knocker

● Rear bolt fix

Code	Dia	Finish
H8070020	165mm	Antique Black

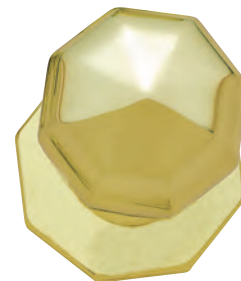

Domed Octagonal Centre Door Knob

● Rear bolt fix

Code	Dia	Finish
H8000061	60mm	Polished Brass
H8022054	60mm	Polished Chrome
H7002054	150mm	Satin Chrome



Stepped Hexagonal Centre Door Knob

● Rear bolt fix

Code	Dia	Finish
H8000063	70mm	Polished Brass
H8022056	70mm	Polished Chrome
H7002058	70mm	Satin Chrome
H8070026	70mm	Antique Black



Stepped Circular Centre Door Knob

● Rear bolt fix

Code	Dia	Finish
H8000062	102mm	Polished Brass
H8022058	102mm	Polished Chrome
H7002080	102mm	Satin Chrome



Door Viewer

● 180 degree angle of vision
● Max door thickness 55mm ● Min door thickness 35mm

Code	Dia	Finish
H8000170	14mm	Polished Brass
H8001010	14mm	Polished Chrome
H8002170	14mm	Satin Chrome



Ultrascope Door Viewer

- 160 degree angle of vision
- Door thickness 44-55mm
- Wide angled view from up to 2M from internal face of door

Code	Dia	Finish
H0101041	38mm	Gold



Door Security Chain

- Door security chain with retainer & plate

Code	Chain	Finish
H8000060	200mm	Polished Brass
H8001050	200mm	Polished Chrome
H7002062	200mm	Satin Chrome

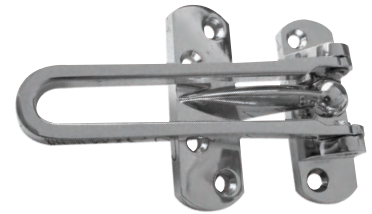

Door Guard

- Door rigid slide pattern security guard

Code	Finish
H8001013	Polished Brass
H8022060	Polished Chrome
H7002082	Satin Chrome

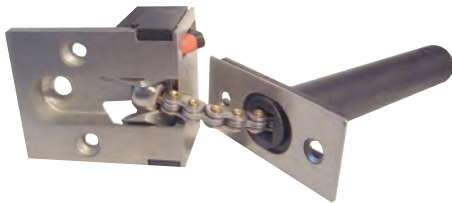

Release Pattern Door Guard

- Door chain release pattern security guard

Code	Finish
H8001012	Polished Brass
H8022060	Polished Chrome
H7002082	Satin Chrome



Victorian Bell Push

- Victorian bell push
- Screw fix

Code	Size	Finish
H8001014	80x30mm	Polished Brass
H8001023	80x30mm	Polished Chrome
H7002086	80x30mm	Satin Chrome



Cylinder Pull

- Plain cylinder pull for round rim cylinder concealed fix

Code	Size	Finish
H8000023	86x44mm	Polished Brass
H8001022	86x44mm	Polished Chrome
H7002088	86x44mm	Satin Chrome





Mila Prolinea Offset Pad/Lever Handle 92/62

- uPVC door furniture for euro profile cylinders
- Spring cassettes & spindles • Offset for 92/62mm centres

Code	Backplate	Finish
H3407000	240mm	Chrome
H3407001	240mm	Gold
H3407002	240mm	White



Mila Prolinea Inline Lever/Lever Handle

- uPVC door furniture for euro profile cylinders
- Spring cassettes & spindles • Inline for 92mm centres

Code	Backplate	Finish
H3407010	240mm	Chrome
H3407011	240mm	Gold
H3407012	240mm	White



Mila Prolinea Inline Pad/Lever Handle

- uPVC door furniture for euro profile cylinders
- Spring cassettes & spindles • Inline for 92mm centres

Code	Backplate	Finish
H3407020	220mm	Chrome
H3407021	220mm	Gold
H3407022	220mm	White



Mila Prolinea Inline Lever/Lever Handle

- uPVC door furniture for euro profile cylinders
- Spring cassettes & spindles • Inline for 92mm centres

Code	Backplate	Finish
H3407030	220mm	Chrome
H3407031	220mm	Gold
H3407032	220mm	White



Mila Slim Master Letter Box Assembly

- uPVC door internal nylon brush seals
- Telescopic sleeve set for 36-70mm door thickness
- Closed cell foam pads for draught sealing

Code	Backplate	Finish
H3407040	316x50mm	White
H3407041	316x50mm	Gold



Espagnolette Handles are perfect for conservatories or other uPVC and timber windows. Handles can be deadlocked for added security.



Mila Prolinea Inline Espagnolette Handle

- Push to engage locking

Code	Spindle	Finish
H3407060	40mm	Chrome
H3407061	40mm	Gold
H3407062	40mm	White



Mila Prolinea Inline TBT Espagnolette Handle

- Tilt Before turn function • Key locking
- Supplied with colour matched screw cover caps
- Suitable for uPVC, timber & aluminium windows

Code	Finish
H3407070	Satin Silver
H3407071	Gold
H3407072	White



Mila Prolinea Offset Espagnolette Handle

- Push to engage locking

Code	Spindle	Hand	Finish
H3407051	40mm	Left	Chrome
H3407052	40mm	Right	Chrome
H3407053	40mm	Left	Gold
H3407054	40mm	Right	Gold
H3407055	40mm	Left	White
H3407056	40mm	Right	White



**Mila Multipoint Locking Mechanism
4 Roller**

- Euro profile locking mechanism
- Lever operated latch & deadbolt
- Twin spindle • 4 rollers

Lift lever to engage locking mechanism and one full turn of cylinder to lock. One full turn of key then push down on the lever to unlock

Code	Faceplate	Backset	Centres
H3408076	16mm	35mm	92/62mm



**Mila Multipoint Locking Mechanism
2 Roller**

- Euro profile locking mechanism
- Lever operated latch & deadbolt
- Single spindle • 2 Rollers

Lift lever to engage locking mechanism and one full turn of cylinder to lock. One full turn of key then push down on the lever to unlock

Code	Faceplate	Backset	Centres
H3408076	16mm	35mm	92mm



**Mila Multipoint Locking Mechanism
2 Hook & 4 Roller**

- Euro profile locking mechanism
- Lever operated latch & deadbolt
- Twin spindle • 2 Hooks & 4 rollers

Lift lever to engage locking mechanism and one full turn of cylinder to lock. One full turn of key then push down on the lever to unlock

Code	Faceplate	Backset	Centres
H3408076	16mm	35mm	92/62mm



Centre Keep

- Centre keep for mila multipoint locking mechanism

Code	Dia	Hand
H3408090	225x30mm	Left
H3408091	225x30mm	Right



Roller Bolt Keep

- Roller bolt keep for mila multipoint locking mechanism

Code	Dia
H3408094	82x30mm



Hook Bolt Keep

- Hook bolt keep for mila multipoint locking mechanism

Code	Dia
H3408098	113x30mm



Patlock Security Lock

- 2 tamper resistant spindles • French door security
- To be used as additional security device & not as a replacement for existing locks
- Removes the risk of lock snapping
- Provides a visual deterrent

Code	Finish
H3408500	White



Door Thresholds & Seals

A quality range of weatherbars, door surrounds and DIY products for timber, composite and uPVC doors. All manufactured to the highest standards, incorporating many unique patented features to prevent the ingress of inclement weather



Tubex Draught Excluder

- High quality rubber
- Compression seal
- 100 metre roll

Code	Size	Finish
H0851001	6mm	White

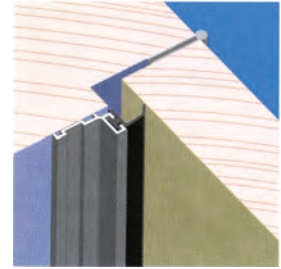

Flex'n'Seal Door Surround

- EDPM rubber gasket
- Aluminium carrier wiping seal

Code	Dia	Finish
H9991016	5180mm	Silver
H9991017	5180mm	Gold



Brushstrip Draught Excluder

- 30mm brushpile
- Aluminium carrier wiping seal

Code	Size	Finish
H9991012	915mm	Silver
H9991013	915mm	Gold
H0852511	2134mm	Silver
H0852512	2134mm	Gold

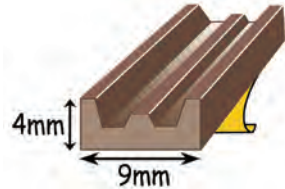

E Strip Draught Excluder

- EDPM rubber
- Self adhesive
- Seals gaps 2-3.5mm
- Compression seal
- 5 metre roll

Code	Size	Finish
H9991000	4x9mm	White
H9991001	4x9mm	Brown

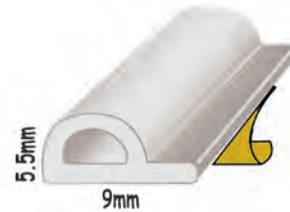

P Strip Draught Excluder

- EDPM rubber
- Self adhesive
- Seals gaps 2-3.5mm
- Compression seal
- 5 metre roll

Code	Size	Finish
H0855736	5.5x9mm	White



Foam Draught Excluder

- Self adhesive
- Compression seal
- 5 Metre roll

Code	Size	Finish
H9991006	4x6mm	White
H9991007	4x6mm	Brown

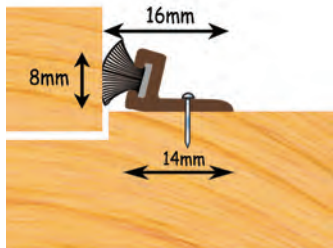

uPVC Pile Weather Set

- Polypropylene Pile
- UPVC carrier
- Wiping seal

Code	Size	Finish
H9991018	5180mm	White
H9991019	5180mm	Brown



MWK20 Door Threshold Seal

- Two part aluminium with rubber seals
- No seals underfoot to be damaged by traffic
- For inward opening doors
- Integral rear thermal barrier prevents condensation

Code	Size	Finish
H9991014	915mm	Silver
H9991015	915mm	Gold



Ultra Mobility Door Threshold Seal (UMT)

- Two Part Aluminium With Rubber Seals
- No seals underfoot to be damaged by traffic
- For inward & outward opening doors

Code	Size	Finish
H0855601	915mm	Silver
H0855602	915mm	Gold



Kleertred Door Threshold Seal

- Two Part Aluminium With Rubber Seals
- No seals underfoot to be damaged by traffic
- For inward & outward opening doors

Code	Size	Finish
H0855621	915mm	Silver
H0855622	915mm	Gold



Macclex Door Threshold Seal

- Aluminium with rubber seal
- No seals underfoot to be damaged by traffic
- For inward opening doors

Code	Size	Finish
H0855521	915mm	Silver
H0855522	915mm	Gold
H0855531	1000mm	Silver
H0855541	1219mm	Silver
H0855542	1219mm	Gold



Threshex Door Threshold Seal

- Aluminium with rubber seal
- No seals underfoot to be damaged by traffic
- For inward and outward opening doors

Code	Size	Finish
H9991008	933mm	Silver
H9991009	933mm	Gold
H0854031	990mm	Silver
H0854032	990mm	Gold
H0854051	1219mm	Silver
H0854052	1219mm	Gold
H0854071	1829mm	Silver
H0854072	1829mm	Gold

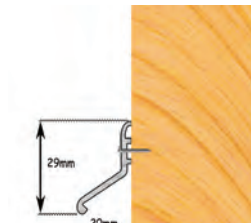

Deflector 20 Rain Deflector

- Aluminium With End Caps

Code	Size	Finish
H9991010	915mm	Silver
H9991011	915mm	Gold

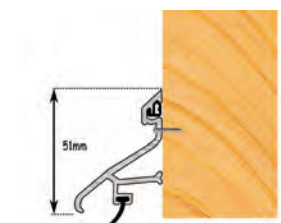

ERD Rain Deflector

- Aluminium With End Cap
- Integral Rubber Seal

Code	Size	Finish
H0855031	915mm	Silver

Locks, Latches & Security

Our extensive range of security solutions include deadlocks, digital locks, night latches and window locks for safeguarding both commercial and domestic properties. Our locks and latches are produced to high standard, meeting all British and European Standards, as well as testing methods covering locks and latches to BS EN 12209.

CYLINDER LOCKS

- All our locks available from stock are standard differ, but can be keyed alike and master keyed. If additional security is required, we offer restricted key sections
- Cylinders can easily be replaced without the need to remove the lock case in order to replace a broken cylinder or to increase the security level
- Our locks are perfect for commercial applications including offices, schools and hospitals

LEVER LOCKS

- Number of levers determines security level, from low security 2 lever to high security 5 lever
- Can be keyed alike
- Suitable for domestic applications

BRITISH STANDARD LOCKS

- These locks are fitted to exterior doors and are tested in order to meet insurance standards.
- Locks are stamped with a BS kitemark and tested to meet either BS3621 or BS8621
- These locks are anti-pick and have hardened steel anti-drill plates
- The bolt throw is also 20mm from the standard 14mm, with hardened rotating steel pins to prevent sawing

- A = Follower
- B = Centres
- C = Backset
- D = Forend
- E = Case Depth
- F = Case Height

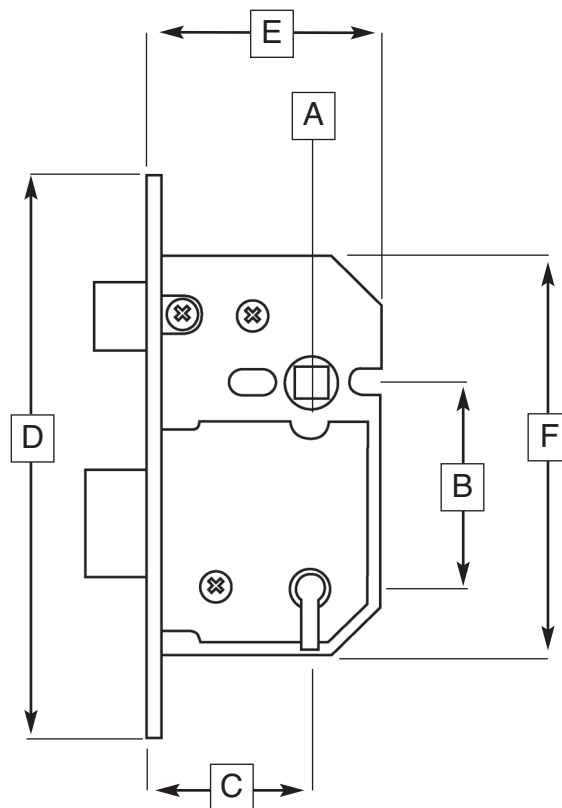



Latch
(sash locks feature a reversible sprung latch that is withdrawn by the handle)

Dead Bolt
(BS locks feature a 20mm hardened bolt)

Forend

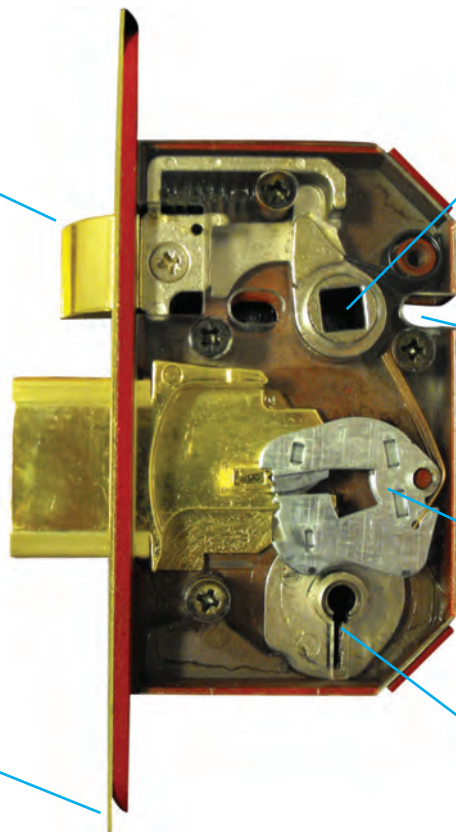

Follower

Holes to accept bolt through furniture

Levers
(BS locks feature at least 5 levers)

Keyway

Mortice Lock Types

British Standard BS3621:2007 locks should be fitted to all external doors in order to comply with insurance requirements.

To meet BS3621:2007, a mortice lock must (in addition to other requirements)

- Have at least 1000 key differs
- Have at least 5 levers (with anti picking features)
- Have a minimum bolt with a throw of 20mm
- Feature anti drill plates
- Box keep for frame



BRITISH STANDARD 5 LEVER

Featuring a 20mm bolt throw and anti-drill plates. They comply with BS3621:2007 or 2004



NON BS 5, 3, & 2 LEVER

These feature lower levels of security and are suitable for internal doors only



ESCAPE LOCKS

Feature egress option by lever or turn on the inside. Usually protected by break glass panel or dome

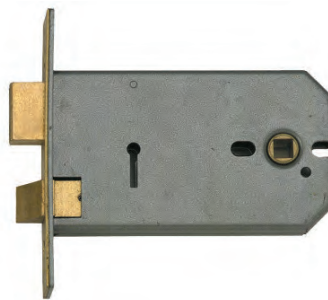

HORIZONTAL MORTICE LOCKS

Featuring a larger backset and are often used with mortice knob furniture



SLIDING MORTICE LOCKS

Locks with hook or clawbolts to suit sliding doors

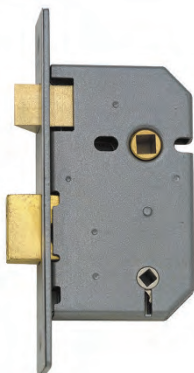

BATHROOM MORTICE LOCKS

These can be used with lever handles and turns and are fitted to bathroom and toilet doors



DIN STANDARD MORTICE LOCKS

Euro profile modular lock cases suitable for commercial projects

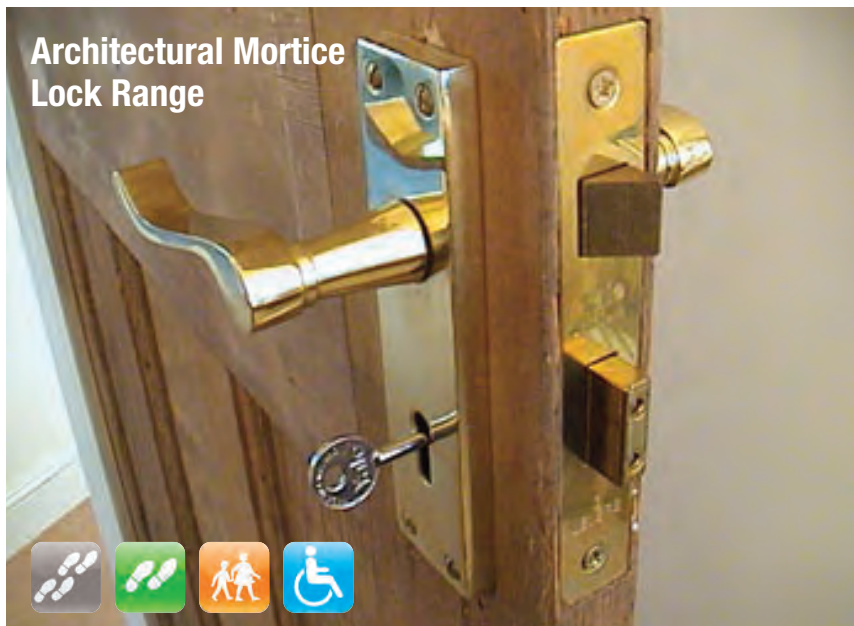

Architectural Mortice Lock Range



N&C Euro Profile Mortice Sashlock Case

- Brass latchbolt
- Brass deadbolt with hardened steel rollers
- Pierced @ 38mm centres for bolt through fixings

152 x 25.5mm forend

Code	Case	Backset	Centres	Finish
H3630002	63mm	43mm	47mm	Polished Brass
H3630004	63mm	43mm	47mm	Satin Chrome
H3630102	76mm	57mm	47mm	Polished Brass
H3630104	76mm	57mm	47mm	Satin Chrome



N&C Euro Profile Mortice Nightlatch Case

- Brass latchbolt
- Brass deadbolt with hardened steel rollers
- Pierced @ 38mm centres for bolt through fixings with hold back function & anti thrust latch

152 x 25.5mm forend

Code	Case	Backset	Centres	Finish
H3630602	63mm	43mm	47mm	Polished Brass
H3630604	63mm	43mm	47mm	Satin Chrome
H3630702	76mm	57mm	47mm	Polished Brass
H3630702	76mm	57mm	47mm	Satin Chrome



N&C Euro Profile Mortice Deadlock Case

- Brass deadbolt with hardened steel rollers
- Pierced @ 38mm centres for bolt through fixings

152 x 25.5mm forend

Code	Case	Backset	Centres	Finish
H3630402	63mm	43mm	47mm	Polished Brass
H3630404	63mm	43mm	47mm	Satin Chrome
H3630502	76mm	57mm	47mm	Polished Brass
H3630504	76mm	57mm	47mm	Satin Chrome



N&C Euro Profile Mortice Small Deadlock Case

- Brass deadbolt with hardened steel rollers
- Pierced @ 38mm centres for bolt through fixings

121 x 25.5mm forend

Code	Case	Backset	Centres	Finish
H3630202	63mm	43mm	47mm	Polished Brass
H3630204	63mm	43mm	47mm	Satin Chrome
H3630302	76mm	57mm	47mm	Polished Brass
H3630304	76mm	57mm	47mm	Satin Chrome



N&C Oval Profile Mortice Small Deadlock Case

- Brass deadbolt with hardened steel rollers
- Pierced @ 38mm centres for bolt through fixings

121 x 25.5mm forend

Code	Case	Backset	Centres	Finish
H3640202	63mm	43mm	47mm	Polished Brass
H3640204	63mm	43mm	47mm	Satin Chrome
H3640302	76mm	57mm	47mm	Polished Brass



N&C Oval Profile Mortice Sashlock Case

- Brass latchbolt
- Brass deadbolt with hardened steel rollers
- Pierced @ 38mm centres for bolt through fixings

152 x 25.5mm forend

Code	Case	Backset	Centres	Finish
H3640002	63mm	43mm	47mm	Polished Brass
H3640004	63mm	43mm	47mm	Satin Chrome
H3640102	76mm	57mm	47mm	Polished Brass
H3640104	76mm	57mm	47mm	Satin Chrome



N&C Oval Profile Mortice Deadlock Case

- Brass Deadbolt with Hardened Steel Rollers
- Pierced @ 38mm centres for bolt through fixings

152 x 25.5mm forend

Code	Case	Backset	Centres	Finish
H3630402	63mm	43mm	47mm	Polished Brass
H3630404	63mm	43mm	47mm	Satin Chrome
H3630502	76mm	57mm	47mm	Polished Brass
H3630504	76mm	57mm	47mm	Satin Chrome

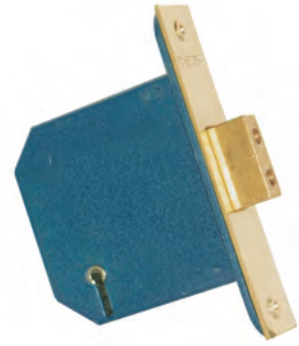

N&C 5 Lever Mortice Sashlock

- Brass latchbolt
- Brass deadbolt with hardened steel rollers
- Pierced @ 38mm centres for bolt through fixings

152 x 25.5mm forend

Code	Case	Backset	Centres	Finish
H3620002	63mm	43mm	47mm	Polished Brass
H3620046	63mm	43mm	47mm	Satin Chrome
H3620102	76mm	57mm	47mm	Polished Brass
H3620104	76mm	57mm	47mm	Satin Chrome

N&C 5 Lever BS Mortice Sashlock

- Brass latchbolt • Anti drill plates • Box keeper
- Brass deadbolt with hardened steel rollers
- Pierced @ 38mm centres for bolt through fixings
- British Standard BS3621

152 x 25.5mm forend

Code	Case	Backset	Centres	Finish
H3621002	63mm	43mm	47mm	Polished Brass
H3621004	63mm	43mm	47mm	Satin Chrome
H3621102	76mm	57mm	47mm	Polished Brass
H3621104	76mm	57mm	47mm	Satin Chrome

N&C 5 Lever Mortice Deadlock

- Brass deadbolt with hardened steel rollers

152 x 25.5mm forend

Code	Case	Backset	Centres	Finish
H3620202	63mm	43mm	47mm	Polished Brass
H3620204	63mm	43mm	47mm	Satin Chrome
H3620302	76mm	57mm	47mm	Polished Brass
H3620304	76mm	57mm	47mm	Satin Chrome

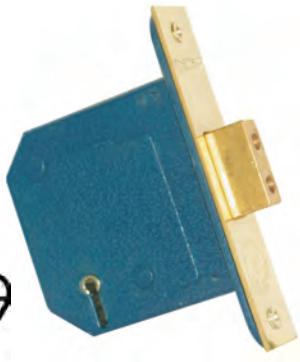
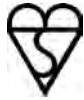

N&C 5 Lever BS Mortice Deadlock

- British Standard BS3621 • Anti drill plates • Box keeper
- Brass deadbolt with hardened steel rollers

152 x 25.5mm forend

Code	Case	Backset	Centres	Finish
H3621202	63mm	43mm	47mm	Polished Brass
H3621204	63mm	43mm	47mm	Satin Chrome
H3621302	76mm	57mm	47mm	Polished Brass
H3621304	76mm	57mm	47mm	Satin Chrome

N&C Mortice Bathroom lock

- Brass latchbolt • Brass deadbolt
- Pierced @ 38mm centres for bolt through fixings
- 8mm square lever handle follower
- 5mm square turn/indicator follower

152 x 25.5mm forend

Code	Case	Backset	Centres	Finish
H3621602	63mm	43mm	47mm	Polished Brass
H3621604	63mm	43mm	47mm	Satin Chrome
H3621702	76mm	57mm	47mm	Polished Brass
H3621704	76mm	57mm	47mm	Satin Chrome

N&C Full Case Mortice Latch

- Brass latchbolt
- Pierced @ 38mm centres for bolt through fixings

152 x 25.5mm forend

Code	Case	Backset	Centres	Finish
H3621802	63mm	43mm	47mm	Polished Brass
H3621804	63mm	43mm	47mm	Satin Chrome
H3621902	76mm	57mm	47mm	Polished Brass
H3621904	76mm	57mm	47mm	Satin Chrome



Union Strongbolt Mortice Locks

Features an easily reversible radius latch that uses the unique Union switchwatch technology, as well as the unique chamfered deadlock design.

Known for its superior strength and exceeding the requirements of BS3621:2007, the StrongBOLT® British Standard 5 lever mortice lock fulfils the security needs of home insurance policies.

The range has been extended to include 3 lever bathroom and cylinder mortice lock cases.



Union Strongbolt 5 Lever Mortice Sashlock

- 2 Keys ● Easily reversible radius latchbolt
- Anti rattle adjustable strike ● Plastic splinter guard

Code	Case	Finish
H0063608	68mm	Polished Brass
H0063609	68mm	Stainless Steel
H0063610	81mm	Polished Brass
H0063611	81mm	Stainless Steel

Union Strongbolt 5 Lever Mortice Deadlock

- 2 Keys ● Easily reversible radius latchbolt
- Anti rattle adjustable strike ● Plastic splinter guard

Code	Case	Finish
H0063612	68mm	Polished Brass
H0063613	68mm	Stainless Steel
H0063614	81mm	Polished Brass
H0063615	81mm	Stainless Steel

Union Strongbolt 5 Lever BS Mortice Sashlock

- 2 Keys ● Easily reversible radius latchbolt
- Anti rattle adjustable strike ● Plastic splinter guard
- British Standard BS3261

Code	Case	Finish
H0063600	68mm	Polished Brass
H0063601	68mm	Stainless Steel
H0063602	81mm	Polished Brass
H0063603	81mm	Stainless Steel

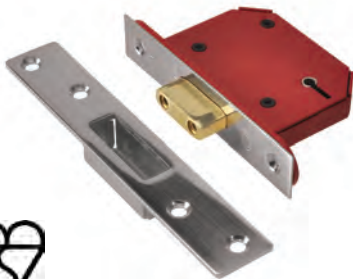

Union Strongbolt 5 Lever BS Mortice Deadlock

- 2 Keys ● Easily reversible radius latchbolt
- Anti rattle adjustable strike ● Plastic splinter guard
- British Standard BS3261

Code	Case	Finish
H0063604	68mm	Polished Brass
H0063605	68mm	Stainless Steel
H0063606	81mm	Polished Brass
H0063607	81mm	Stainless Steel

Union Strongbolt 3 Lever Mortice Sashlock

- 3 Keys ● Easily reversible radius latchbolt
- Anti rattle adjustable strike ● Plastic splinter guard

Code	Case	Finish
H0063616	68mm	Polished Brass
H0063617	68mm	Stainless Steel
H0063618	81mm	Polished Brass
H0063619	81mm	Stainless Steel

Union Strongbolt 3 Lever Mortice Deadlock

- 3 Keys ● Easily reversible radius latchbolt
- Anti rattle adjustable strike ● Plastic splinter guard

Code	Case	Finish
H0063620	68mm	Polished Brass
H0063621	68mm	Stainless Steel
H0063622	81mm	Polished Brass
H0063623	81mm	Stainless Steel



Union Strongbolt Mortice Bathroom Lock

- 5mm follower for turn
- Easily reversible radius latchbolt
- Anti rattle adjustable strike
- Plastic splinter guard

Code	Case	Finish
H0063624	68mm	Polished Brass
H0063625	68mm	Stainless Steel
H0063626	81mm	Polished Brass
H0063627	81mm	Stainless Steel

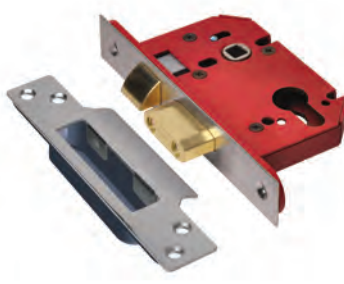

Union Strongbolt Euro Profile Cylinder Mortice Sashlock Case

- Easily reversible radius latchbolt
- Anti rattle adjustable strike
- Plastic splinter guard

Code	Case	Finish
H0063628	68mm	Polished Brass
H0063629	68mm	Stainless Steel
H0063630	81mm	Polished Brass
H0063631	81mm	Stainless Steel



Union Strongbolt Euro Profile Cylinder Mortice Deadlock Case

- Easily reversible radius latchbolt
- Anti rattle adjustable strike
- Plastic splinter guard

Code	Case	Finish
H0063632	68mm	Polished Brass
H0063633	68mm	Stainless Steel
H0063634	81mm	Polished Brass
H0063635	81mm	Stainless Steel

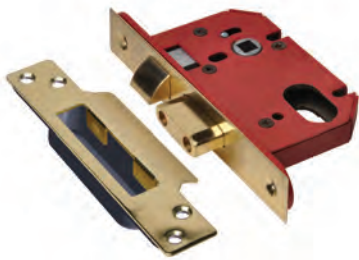

Union Strongbolt Oval Profile Cylinder Mortice Sashlock Case

- Easily reversible radius latchbolt
- Anti rattle adjustable strike
- Plastic splinter guard

Code	Case	Finish
H0063636	68mm	Polished Brass
H0063637	68mm	Stainless Steel
H0063638	81mm	Polished Brass
H0063639	81mm	Stainless Steel



Union Strongbolt Oval Profile Cylinder Mortice Deadlock Case

- Easily reversible radius latchbolt
- Anti rattle adjustable strike
- Plastic splinter guard

Code	Case	Finish
H0063640	68mm	Polished Brass
H0063641	68mm	Stainless Steel
H0063642	81mm	Polished Brass
H0063643	81mm	Stainless Steel

Union Strongbolt Rebate Conversion Set

- To suit all union strongbolt mortice sashlocks

Code	Case	Finish
H0063646	13mm	Polished Brass
H0063647	13mm	Satin Chrome

Union Strongbolt Rebate Conversion Set

- To suit all union strongbolt mortice deadlocks

Code	Case	Finish
H0063644	13mm	Polished Brass
H0063645	13mm	Satin Chrome



How to choose the right cylinder length

Specifying the correct cylinder length is important not only for aesthetic appearance, but also security. It is essential to ensure that the cylinder is as flush with the surrounding hardware as possible to reduce the opportunity for the cylinder to be removed.

A flush fitted cylinder will also reduce movement over time and increase the longevity of the product. When choosing a cylinder length there are three factors to consider:

1. Door thickness
2. Hardware thickness (eg, cylinder roses)
3. Lock position

In most applications the mortice lock will be fitted on the door centreline. Therefore a standard equal length cylinder can be used. However if the lock is fitted off centre then an offset cylinder needs to be specified.



How to measure an equal length double cylinder

Overall Cylinder Length =
door thickness + total hardware thickness

How to measure an offset cylinder length

Overall Cylinder length =
(measure 1 + hardware thickness) +(measure 2 + hardware thickness)

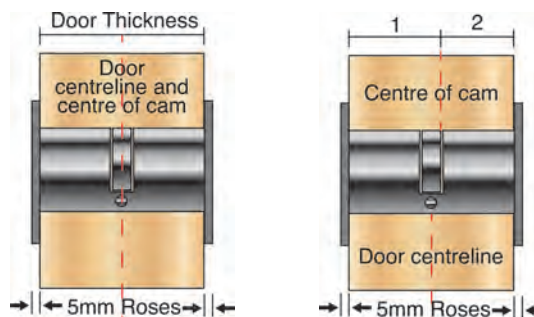

N&C Euro Profile Pin Tumbler Single Cylinder

- 5 Pin mechanism ● Mild steel cam
- Brass body & plug ● Standard differ ● Supplied with 2 keys
- Cylinder retaining screw

Code	Case	Finish
H3631002	40mm	Polished Brass
H3631102	45mm	Polished Brass
H3631202	50mm	Polished Brass
H3631004	40mm	Satin Chrome
H3631104	45mm	Satin Chrome
H3631204	50mm	Satin Chrome

N&C Euro Profile Pin Tumbler Double Cylinder

- Double cylinder ● 5 Pin mechanism ● Mild steel cam
- Brass body & plug ● Standard differ ● Supplied with 2 keys
- Cylinder retaining screw

Code	Case	Finish
H3632002	60mm	Polished Brass
H3632102	70mm	Polished Brass
H3632202	80mm	Polished Brass
H3632004	60mm	Satin Chrome
H3632104	70mm	Satin Chrome
H3632204	80mm	Satin Chrome

N&C Euro Profile Pin Tumbler Cylinder and Thumbturn

- 5 Pin mechanism ● Mild steel cam ● Brass body & plug
- Standard differ ● Supplied with 2 keys
- Cylinder retaining screw

Code	Case	Finish
H3633002	60mm	Polished Brass
H3633102	70mm	Polished Brass
H3633202	80mm	Polished Brass
H3633004	60mm	Satin Chrome
H3633104	70mm	Satin Chrome
H3633204	80mm	Satin Chrome



N&C Oval Profile Pin Tumbler Single Cylinder

- 5 Pin mechanism ● Mild steel cam
- Brass body & plug ● Standard differ ● Supplied with 2 keys
- Cylinder retaining screw

Code	Case	Finish
H3641002	40mm	Polished Brass
H3641102	45mm	Polished Brass
H3631004	40mm	Satin Chrome
H3641104	45mm	Satin Chrome

N&C Oval Profile Pin Tumbler Double Cylinder

- 5 Pin mechanism ● Mild steel cam
- Brass body & plug ● Standard differ ● Supplied with 2 keys
- Cylinder retaining screw

Code	Case	Finish
H3642002	60mm	Polished Brass
H3642102	70mm	Polished Brass
H3642202	80mm	Polished Brass
H3642004	60mm	Satin Chrome
H3642104	70mm	Satin Chrome
H3642204	80mm	Satin Chrome

N&C Oval Profile Pin Tumbler Cylinder and Thumbturn

- 5 Pin mechanism ● Mild steel cam ● Brass body & plug
- Standard differ ● Supplied with 2 keys ● Cylinder retaining screw

Code	Case	Finish
H3643002	60mm	Polished Brass
H3643102	70mm	Polished Brass
H3643202	80mm	Polished Brass
H3643004	60mm	Satin Chrome
H3643104	70mm	Satin Chrome
H3643204	80mm	Satin Chrome

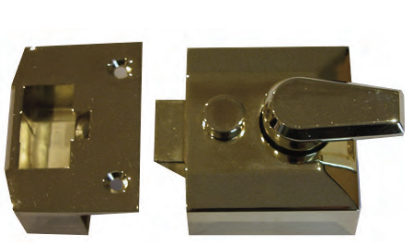

N&C Cylinder Rim Nightlatch

- Narrow stile • Brass latchbolt
- Supplied with 2 keys

Code	Backset	Finish
H8010030	40mm	Polished Brass
H8020030	40mm	Polished Chrome
H8020031	40mm	White
H7030004	40mm	Satin Chrome



N&C Cylinder Rim Nightlatch

- Standard stile • Brass latchbolt
- Supplied with 2 keys

Code	Backset	Finish
H8010020	60mm	Polished Brass
H8020020	60mm	Polished Chrome
H8010021	60mm	White
H8030003	60mm	Satin Chrome



N&C Traditional Cylinder Rim Nightlatch

- Standard stile • Brass latchbolt
- Supplied with 2 keys

Code	Backset	Finish
H8010050	60mm	Green Brass
H8020050	60mm	Silver Chrome
H8010060	60mm	Polished Brass
H8020060	60mm	Polished Chrome



N&C Rim Cylinder

- Supplied with 2 keys

Code	Finish
H8010040	Polished Brass
H8020040	Polished Chrome

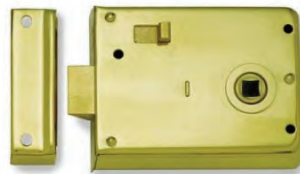

N&C Rim Latch With Internal Locking Snib

- Polished case & staple • 3 Lever mechanism
- Supplied with 2 keys

Code	Finish
H8010002	Polished Brass

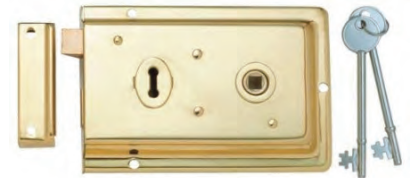

N&C Rim Lock

- Polished case & staple • 3 Lever mechanism
- Supplied with 2 keys

Code	Finish
H8010001	Polished Brass

Typical Master Key Control System

For more information, please contact one of our experienced ironmongery sales team

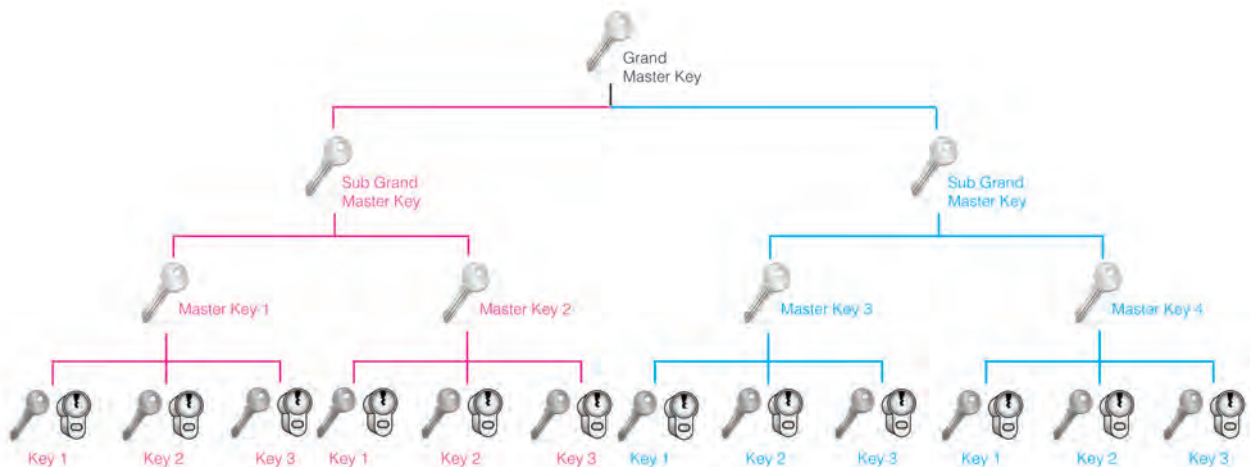

Yale Locks



Yale has a comprehensive range of nightlatches suitable for all applications and security needs, including locks to meet BS 3621 & BS 8621.

Yale's long standing history & experience in the manufacture of nightlatches means that the locks are commonly referred to as "Yale locks".



Yale PBS1 Nightlatch

- British Standard cylinder rim nightlatch
- 2 Keys • 20mm bolt • Anti thrust protection • Anti drill
- Anti pick anti bump • 6 Pin cylinder • Auto deadlocking

Code	Backset	Cylinder	Case
H0185522	60mm	Brass	Brasslux
H0185521	60mm	Brass	Gunmetal
H0185523	60mm	Chrome	Chrome



Yale PBS2 Nightlatch

- British Standard cylinder rim nightlatch for narrow stiles
- 2 Keys • 20mm bolt • Anti thrust protection • Anti drill
- Anti pick anti bump • 6 pin cylinder • Auto deadlocking

Code	Backset	Cylinder	Case
H0185532	40mm	Brass	Brasslux
H0185533	40mm	Chrome	Chrome

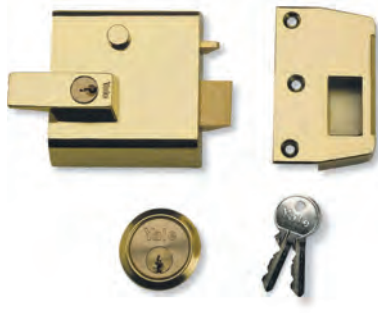

Yale No 1 Nightlatch

- Double Locking cylinder rim nightlatch
- 2 Keys • 20mm Bolt • Anti thrust protection
- Deadlocking by key internally

Code	Backset	Cylinder	Case
H0185512	60mm	Brass	Brasslux



Yale No 2 Nightlatch

- Double Locking cylinder rim nightlatch for narrow stiles
- 2 Keys • 20mm Bolt • Anti thrust protection
- Deadlocking by key internally

Code	Backset	Cylinder	Case
H0185502	40mm	Brass	Brasslux



Yale 89 Nightlatch

- Double Locking cylinder rim nightlatch
- 2 Keys • Deadlocking by key externally

Code	Backset	Cylinder	Case
H0184513	60mm	Brass	Brasslux
H0184514	60mm	Chrome	Chrome
H0184511	60mm	Brass	Gunmetal
H0184512	60mm	Chrome	Gunmetal



Yale 88 Nightlatch

- Standard cylinder rim nightlatch
- 2 Keys • Deadlocking by snib internally

Code	Backset	Cylinder	Case
H0184521	60mm	Brass	Gunmetal
H0184522	60mm	Chrome	Gunmetal



Yale 85 Nightlatch

- Deadlocking cylinder rim nightlatch for narrow stiles
- 2 Keys • Deadlocking by key externally

Code	Backset	Cylinder	Case
H0184503	40mm	Brass	Brasslux
H0184504	40mm	Chrome	Chrome
H0184501	40mm	Brass	Gunmetal
H0184502	40mm	Chrome	Gunmetal



Yale 82 Nightlatch

- Deadlocking cylinder rim nightlatch
- 2 Keys • Deadlocking by key externally & snib internally

Code	Backset	Cylinder	Case
H0187002	60mm	Brass	Gunmetal
H0187001	60mm	Chrome	Gunmetal



Yale 81 Nightlatch

- Rollerbolt cylinder rim nightlatch
- 2 Keys • Deadlocking by key externally & snib internally

Code	Backset	Cylinder	Case
H0186501	60mm	Brass	Gunmetal
H0186502	60mm	Chrome	Gunmetal



Yale 77 Nightlatch

- Standard cylinder rim nightlatch • 2 Keys

Code	Backset	Cylinder	Case
H0184001	60mm	Brass	Bronze
H0184002	60mm	Chrome	Gunmetal



Yale 706 Nightlatch

- Standard cylinder rim nightlatch • 2 Keys
- For narrow stiles

Code	Backset	Cylinder	Case
H0184021	40mm	Brass	Bronze
H0184022	60mm	Chrome	Bronze

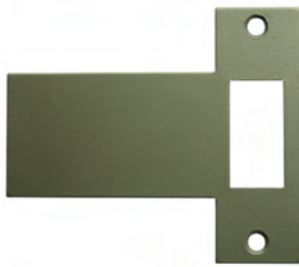

Yale Long Lipped Strikeplate

- Long lipped strikeplate for standard nightlatches
- For outward opening doors

Code	Finish
H0184011	Bronze



Yale 1109 Rim Cylinder

- Yale 1109 replacement rim cylinder
- 2 Keys

Code	Finish
H0188501	Polished Brass
H0188500	Polished Chrome
H0188503	Satin Chrome



Contract Din Standard Locks

A range of modular euro profile mortice locks where the case size and shape remains the same throughout the range regardless of the function. Features the Easi-T reversible latchbolt, perfect for use in commercial applications.

The 72mm centres between the handle and the cylinder assists the visually impaired with operating the lock.

Ideal for heavy duty commercial applications.

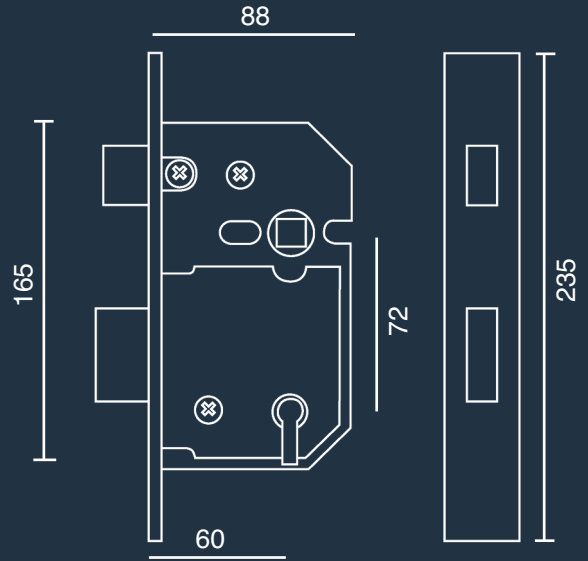

N&C Din Standard Euro Profile Mortice Sashlock Case

- One piece square forend
- Reversible latchbolt
- Lever handle withdraws latchbolt
- Cylinder withdraws deadbolt
- Strike plate includes white dustcaps

235 x 24mm forend

Code	Case	Backset	Centres	Finish
H2900535	85mm	60mm	72mm	Stainless Steel



N&C Din Standard Mortice Latch Case

- One piece square forend
- Reversible latchbolt
- Lever handle withdraws latchbolt
- Strike plate includes white dustcaps

235 x 24mm forend

Code	Case	Backset	Centres	Finish
H2900538	85mm	60mm	72mm	Stainless Steel



N&C Din Standard Euro Profile Mortice Deadlock Case

- One piece square forend
- Cylinder throws deadbolt to 22mm
- Strike plate includes white dustcaps

235 x 24mm forend

Code	Case	Backset	Centres	Finish
H2900536	85mm	60mm	72mm	Stainless Steel



N&C Din Standard Mortice Bathroom Lock Case

- One piece square forend
- Reversible latchbolt
- Lever handle withdraws latchbolt
- Thumbturn (5mm follower) throws deadbolt to 11mm
- Strike plate includes white dustcaps

235 x 24mm forend

Code	Case	Backset	Centres	Finish
H2900537	85mm	60mm	78mm	Stainless Steel



N&C Din Standard Euro Profile Mortice Nightlatch Case With Anti Thrust Bolt

- One piece square forend
- Reversible latchbolt
- Lever handle & cylinder withdraws latchbolt
- Strike plate includes white dustcaps

235 x 24mm forend

Code	Case	Backset	Centres	Finish
H2900540	85mm	60mm	72mm	Stainless Steel



N&C Din Standard Euro Profile Mortice Escape Sashlock Case With Split Follower Reversible Handing Includes Split Spindle

- One piece square forend
- Reversible latchbolt
- Lever handle & cylinder withdraws latchbolt
- Strike plate includes white dustcaps

235 x 24mm forend

Code	Case	Backset	Centres	Finish
H2900539	85mm	60mm	72mm	Stainless Steel

Fire Brigade Locks

Fire Brigade Locks are operated by common keys that are kept by Fire Brigade, Police, Ambulance Services and other authorised personnel. They should not therefore be relied upon for security applications. With the exception of the yellow padlocks all options are supplied either grey hammered, galvanised or satin finish. Applications include gates and shutters, barriers, hoardings, common area stores and doors.

- Supplied without keys, see below
- Some options are handed
- Mortice and rim locks are supplied with aluminium escutcheons

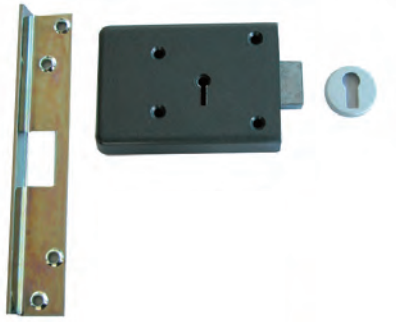

FB1 Fire Brigade Rim Deadlock

- FB1 rim deadlock • Supplied with aluminium escutcheon
- Outward opening strikeplate

Code	Backset	Hand	Case	Finish
H0140001	45mm	Left	110x80mm	Grey Case
H0140011	45mm	Right	110x80mm	Grey Case

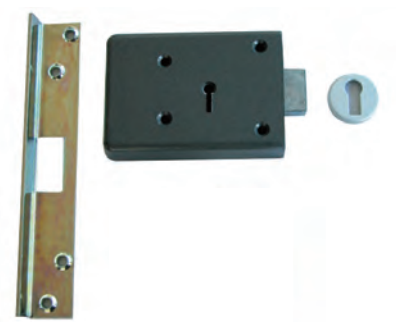

FB2 Fire Brigade Rim Deadlock

- FB2 rim deadlock • Supplied with aluminium escutcheon
- Outward opening strikeplate

Code	Backset	Hand	Case	Finish
H0140501	45mm	Left	110x80mm	Grey Case
H0140511	45mm	Right	110x80mm	Grey Case

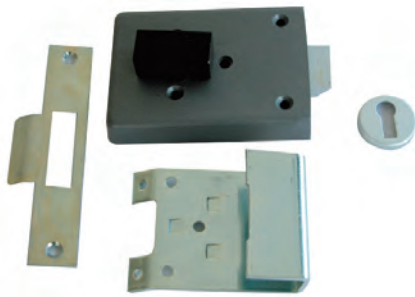

FB4 Fire Brigade Rim Slamlock

- FB4 rim slamlock • Supplied with aluminium escutcheon
- Inward opening strikeplate

Code	Backset	Hand	Case	Finish
H0141001	45mm	Left	110x80mm	Grey Case
H0141002	45mm	Right	110x80mm	Grey Case

- Outward Opening Strikeplate

H0141011	45mm	Left	110x80mm	Grey Case
H0141012	45mm	Right	110x80mm	Grey Case

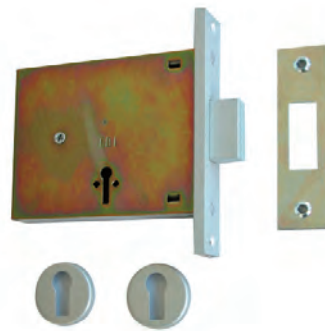

FB1 Fire Brigade Mortice Deadlock

- FB1 mortice deadlock
- Supplied with 2 aluminium escutcheon

Code
H0141501



FB2 Fire Brigade Mortice Deadlock

- FB2 mortice deadlock
- Supplied with 2 aluminium escutcheon

Code
H0141511



FB47 Fire Brigade Padlock

- FB47 fire brigade padlock • 2 lever mechanism

Code	Case	Finish
H0143001	50mm	Galvanised
H0143011	including chain 50mm	Galvanised



FB14 Fire Brigade Padlock

- FB14 padlock • 4 lever mechanism

Code	Case	Finish
H0143002	64mm	Galvanised Yellow



FB11 Fire Brigade Padlock

- FB11 padlock • 4 lever mechanism

Code	Case	Finish
H0143003	64mm	Galvanised



Fire Brigade Keys

Code	Description
H0142501	FB1 Standard Key
H0142502	FB2 Standard Key
H0142503	FB4 Standard Key
H0142511	FB1 Extra Long Key
H0142514	FB4 Extra Long Key

Code	Description
H0143021	FB11 Padlock Key
H0143031	FB14 Padlock Key
H0143041	FB11 Padlock Key



N&C Phlexicare RADAR Key Scheme

Disability Rights UK (formerly RADAR) are a charity that promotes a national key scheme (NKS) whereby RADAR locks are fitted to public toilets and can only be operated using a RADAR key.

Nicholls & Clarke, together with RADAR launched the NKS in 1981 with thousands of locks installed throughout the UK, with hundreds of thousands of keys in circulation.

These keys are available to disabled or registered blind people to enable them to access the facility.

Non RADAR key holders are denied access to the facility, protecting them against vandalism or misuse, so that a clean functional toilet is available.

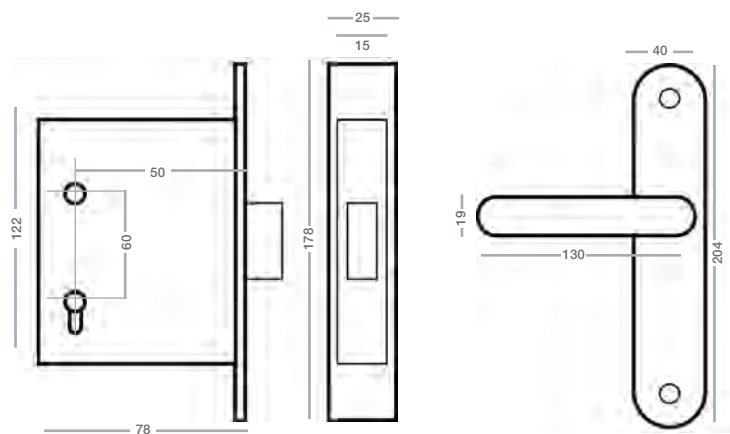
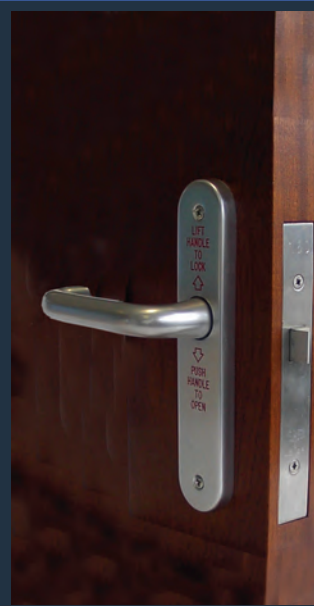

N&C Phlexicare Radar Lockset

- National Key Scheme ● Anodised aluminium
- Plate with matching internal plate with lever handle
- Supplied with one bow handle key

Right hand				
Code	Case	Backset	Centres	Finish
H0148502	78mm	50mm	60mm	Polished Silver

Left hand				
Code	Case	Backset	Centres	Finish
H0148503	78mm	50mm	60mm	Polished Silver

Right hand				
Code	Case	Backset	Centres	Finish
H0148505	78mm	50mm	60mm	Polished Gold

Left hand				
Code	Case	Backset	Centres	Finish
H0148506	78mm	50mm	60mm	Polished Gold



N&C Phlexicare Radar Key

- National Key Scheme ● Anodised aluminium

	Code	Finish
Standard Pattern Radar Key	H0149001	Silver

	Code	Finish
Bow Pattern Radar Key	H0149002	Silver



N&C Phlexicare Radar Cover Plate

- External cover plate for Phlexicare Radar lockset
- Provides colour contrast for those with visual impairment
- Reversible without Text

Code	Case	Finish
H0149011	300x80mm	ABS Plastic Yellow
H0149012	300x80mm	ABS Plastic Green
H0149013	300x80mm	ABS Plastic Red
H0149014	300x80mm	ABS Plastic Black
H0149015	300x80mm	ABS Plastic Grey
H0149016	300x80mm	ABS Plastic White
H0149017	300x80mm	ABS Plastic Blue

In addition to the traditional RADAR mortice lockset, the RADAR padlock provide an extension to the National Key Scheme (NKS) and has been adopted by the National Trust, the railways and similar organisations.

In rural areas it may be necessary to prevent stock straying or horses or motorcycles from damaging footpaths.



N&C Phlexicare Radar Padlock

- National Key Scheme ● 2 Lever mechanism
- Brass weather resistant components ● Keys not included

Code	Size	Finish
H0149003	60mm	Red

N&C Phlexicare Radar Hasp & Staple

Code	Finish
H0149004	Red



Unican L 1000-1 Digital Lock

- Heavy duty mechanical digital lock ● Lever handle
- Auto deadlocking with key over-ride

Left hand

Code	Size	Finish
H0201051	187x79mm	Satin Chrome

Right hand

Code	Size	Finish
H0201052	187x79mm	Satin Chrome



Unican 1000-1 Digital Lock

- Heavy duty mechanical digital lock
- Knob handle operation
- Auto deadlocking with key over-ride

Code	Size	Finish
H0201511	187x79mm	Satin Chrome



Unican 7000 Digital Lock

- Medium duty mechanical digital lock
- Knob handle operation ● Auto deadlocking

Code	Size	Finish
H0201041	155x56mm	Satin Chrome
H0201042	155x56mm	Polished Brass



Briton 9160 Digital Lock

- Light duty mechanical digital lock ● Knob handle operation
- Auto deadlocking ● Dual function backplate provides optional hold open facility

Code	Backset	Finish
H0201095	60mm	Silver
H0201096	60mm	Polished Brass



Ask the
EXPERT

Our team of ironmongery specialists are on hand to help you with your project requirements. Call us on 0208 586 4600

Padlocks & Bars

A range of low and medium level security padlocks ideal for tool boxes, sheds and gardens.



N&C Brass Padlock

- Solid brass body padlock with 2 keys
- Hardened steel shackle • Pick resistant cylinder

Code	Size	Shackle Clearance	Finish
H0161501	20mm	12mm	Polished Brass
H0161503	30mm	19mm	Polished Brass
H0161504	40mm	22mm	Polished Brass
H0161505	50mm	30mm	Polished Brass
H0161506	60mm	34mm	Polished Brass



N&C Laminated Steel Padlock

- Strong laminated steel body with 2 keys
- Hardened steel shackle • Pick resistant cylinder

Code	Size	Shackle Clearance	Finish
H0161001	30mm	18mm	BZP
H0161002	40mm	22mm	BZP
H0161003	50mm	25mm	BZP
H0161004	60mm	34mm	BZP



N&C Old English Padlock

- Old english padlock with 2 keys
- 4 Lever lock mechanism • Brass keyhole cover
- Reliable in all outdoor or marine environments

Code	Size	Shackle Clearance	Finish
H9990123	38mm	11mm	Galvanised
H9990124	51mm	18mm	Galvanised
H9990125	64mm	21mm	Galvanised



N&C Recodable Padlocks

- 3 Wheel recodable combination padlock
- Ideal for luggage

Code	Size	Shackle Clearance	Finish
H9990148	22mm	22mm	Brass
H9990149	30mm	26mm	Brass



N&C High Security Padlock

- High security padlock with 2 keys • Closed shackle
- Hardened forged shackle • Laminated steel body
- 5 lever mechanism

Code	Size	Shackle Clearance	Finish
H0162001	66mm	15mm	Zinc Plated



N&C Wire Hasp & Staple

- Wire pattern hasp & staple

Code	Size	Finish
H0168001	102mm	Black
H0168002	127mm	Black
H0168003	152mm	Black



N&C Safety Hasp & Staple

- Concealed fixings when in closed position

Code	Size	Finish
H0167501	76mm	Zinc Plated
H0167502	114mm	Zinc Plated
H0167503	152mm	Zinc Plated



N&C Vertical Locking Bar

- Strong vertical locking bar

Code	Size	Finish
H0168511	150mm	Mild Steel



N&C Horizontal Locking Bar

- Strong horizontal locking bar
- Concealed fixings when closed

Code	Size	Finish
H0162501	200mm	Mild Steel



N&C Locking Bar

- Strong malleable iron locking bar to swivel

Code	Size	Finish	Code	Size	Finish
H0166001	254mm	Black	H0166011	254mm	Galvanised
H0166002	305mm	Black	H0166012	305mm	Galvanised
H0166003	354mm	Black	H0166013	354mm	Galvanised
H0166004	457mm	Black	H0166014	457mm	Galvanised

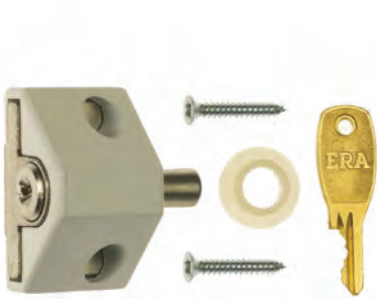

Patio Door Lock

- Patio door lock with 2 keys
- Suitable for most types of wooden, aluminium & upvc sliding patio door
- Push bolt to lock • Release with key

Code	Case	Finish
H0110002	46x27x26mm	White



Universal Bolt

- Universal press bolt with 1 key • Push bolt to lock
- Suitable for most types of wood & metal doors & windows
- Release with key

Code	Size	Finish
H0112501	110x10mm	White



Multi Purpose Bolt

- Multi purpose press bolt with 1 key
- Suitable for most wood & metal hinged & sliding doors
- Push bolt to lock • Release with key

Code	Size	Finish
H0113001	140x10mm	White

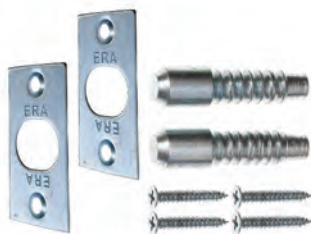

Hinge Bolts

- Hinge bolt
- Secures hinge side of door to frame
- Fully concealed when door closed

Code	Finish
H0110501	Satin Chrome



Securichain

- Security door chain
- Automatically restricts door opening
- Can only be unlocked when door is closed
- Fully concealed when door closed

Code	Finish
H0122501	Satin Chrome
H0122502	Brass Effect



N&C London Bar

- Reinforcing bar with d shaped staple to fit over & secure the staple of a cylinder rim nightlatch

Code	Size	Finish
H0122701	1830mm	White

N&C Birminham Bar

- Dual purpose flat security bar to strengthen either the hinge side of the doorframe or to the lockside where a mortice lock is fitted

Code	Size	Finish
H0122702	1830mm	White





N&C Tubular Latch

- Tubular mortice latch • Brass bolt
- Pierced @ 38mm centres for bolt through fixings

Code	Case	Backset	Finish
H0041002	64mm	45mm	Electro Brass
H0041004	76mm	57mm	Electro Brass
H0041001	64mm	45mm	Nickel Plated
H0041003	76mm	57mm	Nickel Plated



N&C Double Spring Tubular Latch

- Double spring tubular mortice latch • Brass bolt
- Larger backset makes this suitable for mortice knob furniture

Code	Case	Backset	Finish
H8010009	100mm	77mm	Electro Brass
H8010010	151mm	127mm	Electro Brass
H8020009	100mm	77mm	Stainless Steel
H8020010	151mm	127mm	Stainless Steel



N&C Rollerbolt Catch

- Adjustable mortice rollerbolt catch

Code	Size	Finish
H8010018	32x48mm	Electro Brass
H8020018	32x48mm	Stainless Steel



N&C Bathroom Deadbolt

- Mortice bathroom deadbolt
- Brass deadbolt • 5mm follower

Code	Case	Backset	Finish
H8000055	76mm	57mm	Electro Brass
H8001047	76mm	57mm	Stainless Steel



N&C Mortice Sashlock

- 3 Lever mortice sashlock with 2 keys
- Brass latchbolt • Brass deadbolt

Code	Case	Backset	Finish
H8010005	64mm	45mm	Electro Brass
H8010006	76mm	57mm	Electro Brass
H8020005	64mm	45mm	Satin Chrome
H8020006	76mm	57mm	Satin Chrome

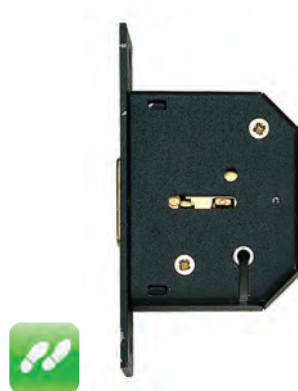

N&C Mortice Deadlock

- 3 Lever mortice sashlock with 2 keys
- Brass deadbolt

Code	Case	Backset	Finish
H8010011	64mm	45mm	Electro Brass
H8010012	76mm	57mm	Electro Brass
H8020011	64mm	45mm	Satin Chrome
H8020012	76mm	57mm	Satin Chrome



N&C Mortice Bathroom Lock

- Mortice bathroom lock
- 5mm follower for thumbturn
- Brass latchbolt

Code	Case	Backset	Finish
H8010007	64mm	45mm	Electro Brass
H8010008	76mm	57mm	Electro Brass
H8020007	64mm	45mm	Satin Chrome
H8020008	76mm	57mm	Satin Chrome



N&C Mortice Sashlock

- 5 lever mortice sashlock with 2 keys
- Brass deadbolt with hardened steel rollers
- Brass latchbolt • Box strikeplate

Code	Case	Backset	Finish
H8010013	64mm	45mm	Electro Brass
H8010013	76mm	57mm	Electro Brass
H8020013	64mm	45mm	Satin Chrome
H8020013	76mm	57mm	Satin Chrome



N&C Mortice Deadlock

- 5 lever mortice sashlock with 2 keys
- Brass deadbolt with hardened steel rollers
- Box strikeplate

Code	Case	Backset	Finish
H8010015	64mm	45mm	Electro Brass
H8010016	76mm	57mm	Electro Brass
H8020015	64mm	45mm	Satin Chrome
H8020016	76mm	57mm	Satin Chrome

Hinges

At Nicholls and Clarke, we offer a comprehensive range of single axis hinges for a variety of applications such as door, gate, cabinet and windows. All types of applications from heavy duty commercial to lightweight internal doors and furniture fittings.

Select from high quality butt hinges, continuous hinges and spring hinges using the selection charts below.

Our products, where appropriate, meet British and European Standards and Testing methods that cover single axis hinges (BS EN 1935).

The type of hinge and size chosen is dependent on door mass and test cycles (See table below).

Door type	Size (mm)	Mass (kg)	Duty
Cupboard, wardrobe, cabinet, louvered door and shutters	2040 x 626 x 400	3 to 10	Light
Light internal large wardrobe and large louvered doors	2040 x 926 x 40	10 to 17.5	Light
Medium internal doors	2040 x 1012 x 40	17.5 to 25	Medium
Heavy internal doors	2040 x 1012 x 40	25 to 37.5	Medium
Half hour fire doors	2040 x 826 x 44	25 to 37.5	Heavy
Light external fire doors	2040 x 907 x 40	20 to 37.5	Heavy
Heavy external fire doors	2040 x 1002 x 44	37.5 to 55	Heavy
One hour fire doors	2040 x 826 x 54	37.5 to 72.5	Heavy
Oversize or special external doors	2040 x 1200	55 to 110	Heavy

Frequency of Door Operation			
Type of Building and Door	Test Cycles (frequency)		Hinge Type
	Daily	Yearly	
Large dept. store entrance	5,000	1,500,000	High frequency } Heavy Weight
Large office bldg. entrance	4,000	1,200,000	
School entrance	1,250	225,000	
School toilet door	1,250	225,000	
Store or bank entrance	500	50,000	
Office bldg. toilet door	400	118,000	
School corridor door	80	15,000	Av. frequency } Standard Weight Anti-Friction Bearing (except on heavy doors)
Office bldg. corridor door	75	22,000	
Store toilet door	60	18,000	
Dwelling entrance	40	15,000	
Dwelling toilet door	25	9,000	Low frequency } Plain Bearing Hinges may be used on light doors
Dwelling corridor door	10	3,600	
Dwelling closet door	6	2,200	



All hinges should be fitted in accordance with templates where supplied and/or fitting instructions provided. All hinge pins should be in vertical alignment. Where required, hinges should be lubricated immediately after fixing, and at regular intervals, to avoid undue wear on the knuckles, strain on the fixings and stress on the door closers if fitted.



Hi Load Three Knuckle Hinge H207

- Max door weight 120kg ● BS EN 1935 Grade 13
- Marked certifiere approved ● Concealed bearing

Code	Size	Finish
H0444905	102x76x3mm	Satin Stainless Steel



Hi Load Three Knuckle Hinge H208

- Max door weight 120kg ● BS EN 1935 Grade 13
- Marked certifiere approved ● Concealed bearing

Code	Size	Finish
H0444906	102x89x3mm	Satin Stainless Steel



Hi Load Three Knuckle Hinge H209

- Max door weight 120kg ● BS EN 1935 Grade 13
- Marked certifiere approved ● Concealed bearing

Code	Size	Finish
H0444907	102x102x3mm	Satin Stainless Steel



Hi Load Three Knuckle Hinge H102

- Max door weight 120kg ● BS EN 1935 Grade 13
- Marked certifiere approved

Code	Size	Finish
H0444601	100x88x3mm	Bright Zinc Plated
H0444602	100x88x3mm	Satin Nickel Plated
H0444603	100x88x3mm	Satin Stainless Steel
H0444605	100x88x3mm	Polished Brass



Hi Load Three Knuckle Hinge H103

- Max door weight 100kg ● BS EN 1935 Grade 12
- Marked certifiere approved

Code	Size	Finish
H0444901	100x86x2.5mm	Bright Zinc Plated



Hi Load Three Knuckle Hinge H104

- Max door weight 80kg ● BS EN 1935 Grade 11
- Marked certifiere approved

Code	Size	Finish
H0444902	100x75x2.3mm	Bright Zinc Plated



Hi Load Two Knuckle Lift Off Hinge H101

- Max door weight 80kg ● BS EN 1935 Grade 11
- Marked certifiere approved ● Radius corners

Code	Size	Hand	Finish
H0444701	100x88x3mm	Left	Bright Zinc Plated
H0444721	100x88x3mm	Right	Bright Zinc Plated



Hi Load Two Knuckle Lift Off Hinge H105

- Max door weight 80kg ● BS EN 1935 Grade 11
- Marked certifiere approved ● Radius corners

Code	Size	Hand	Finish
H0444903	98x84x2mm	Left	Bright Zinc Plated
H0444908	98x84x2mm	Right	Bright Zinc Plated



Hi Load Two Knuckle Lift Off Hinge H107

- Max door weight 120kg ● BS EN 1935 Grade 13
- Marked certifiere approved ● Radius corners

Code	Size	Hand	Finish
H0444904	110x98x3.2mm	Left	Bright Zinc Plated
H0444908	110x98x3.2mm	Right	Bright Zinc Plated



All hinges on this page are from the Hi Load Range manufactured by Royde and Tucker





N&C Five Knuckle Twin Ball Race Hinges

- Max door weight 120kg • BS EN 1935 Grade 13
- Marked certifiere approved

Code	Size	Finish
H0442717	102x76x3mm	Polished Stainless Steel
H0442716	102x76x3mm	Satin Stainless Steel
H0442718	102x76x3mm	PVD (Brass)



N&C Three Knuckle Self Lubricating Butt Hinge

- Max door weight 120kg • BS EN 1935 Class 9
- Marked certifiere approved

Code	Size	Finish
H0442803	102x76x3mm	Polished Stainless Steel
H0442804	102x76x3mm	Satin Stainless Steel



N&C Five Knuckle Twin Ball Race Hinges

- Max door weight 120kg • BS EN 1935 Grade 7
- Marked certifiere approved

Code	Size	Finish
H0442715	102x76x3mm	Bright Zinc Plated
H0442713	76x50x2mm	Polished Stainless Steel
H0442701	76x50x2mm	Satin Stainless Steel



N&C Five Knuckle Hinges

- Max door weight 120kg

Code	Size	Finish
H0442511	102x76x2mm	Satin Stainless Steel
H0442501	76x50x2mm	Satin Stainless Steel



N&C Five Knuckle Double Pressed Steel Hinge

- 899 Pattern

Code	Size	Finish
H0441521	150mm	Self Colour Steel
H0441511	100mm	Self Colour Steel
H0441501	75mm	Self Colour Steel

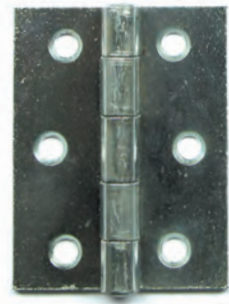

N&C Five Knuckle Medium Steel Hinge

- 451 Pattern

Code	Size	Finish
H0441011	100mm	Self Colour Steel
H0441001	75mm	Self Colour Steel
H8021013	100mm	Bright Zinc Plated
H8011012	100mm	Electro Brass Plated

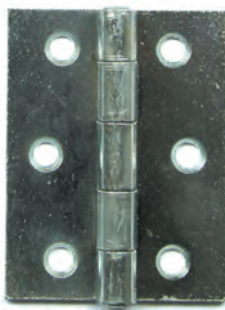

N&C Five Knuckle Light Steel Hinge

- 1838 Pattern

Code	Size	Finish
H0440041	100mm	Self Colour Steel
H0440031	75mm	Self Colour Steel
H0440021	50mm	Self Colour Steel
H0440011	40mm	Self Colour Steel
H8021021	100mm	Bright Zinc Plated
H8021020	75mm	Bright Zinc Plated
H8011016	100mm	Electro Brass Plated
H8011015	75mm	Electro Brass Plated



N&C Five Knuckle Light Steel Hinge Loose Pin

- 1840 Pattern

Code	Size	Finish
H8021023	100mm	Bright Zinc Plated
H8021022	75mm	Bright Zinc Plated
H8011020	100mm	Electro Brass Plated
H8011019	75mm	Electro Brass Plated



N&C Rising Steel Hinge

- Two knuckle steel rising hinge

Code	Size	Hand	Finish
H0451011	100mm	Right	Self Colour Steel
H0451012	100mm	Left	Self Colour Steel
H0451001	75mm	Right	Self Colour Steel
H0451002	75mm	Left	Self Colour Steel
H0451021	100mm	Right	Bright Zinc Plated
H0451022	100mm	Left	Bright Zinc Plated
H8011061	100mm	Right	Electro Brass Plated
H8011060	100mm	Left	Electro Brass Plated
H8011051	75mm	Right	Electro Brass Plated
H8011050	75mm	Left	Electro Brass Plated
H8021070	100mm	Right	Stainless Steel
H8021072	100mm	Left	Stainless Steel



N&C Flush Steel Hinges

- Three knuckle flush steel hurlinge

Code	Size	Finish
H0450031	100mm	Bright Zinc Plated
H8021017	75mm	Bright Zinc Plated
H8021016	63mm	Bright Zinc Plated
H8021015	50mm	Bright Zinc Plated
H8021014	40mm	Bright Zinc Plated



N&C Flush Steel Hinges

- Three knuckle flush steel hurlinge

Code	Size	Finish
H0450032	100mm	Electro Brass Plated
H8011024	75mm	Electro Brass Plated
H8011023	63mm	Electro Brass Plated
H8011022	50mm	Electro Brass Plated
H8011021	40mm	Electro Brass Plated



N&C Steel Back Flap Hinges

- Three knuckle steel backflap hinge

Code	Size	Finish
H0452001	25x75mm	Self Colour Steel
H0452011	32x80mm	Self Colour Steel
H0452021	38x90mm	Self Colour Steel
H0452031	50x105mm	Self Colour Steel
H0452041	65x150mm	Self Colour Steel



N&C Five Knuckle Brass Hinges DPBW

- Five knuckle brass hinge
- Double phosphor bronze washers

Code	Size	Finish
H8011002	76x50x3mm	Polished Brass
H8011003	102x67x3mm	Polished Brass
H8011004	102x76x3mm	Polished Brass
H8021000	76x50x3mm	Polished Chrome
H8021001	102x67x3mm	Polished Chrome
H8021002	102x76x3mm	Polished Chrome

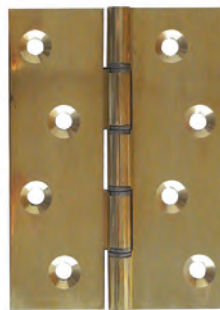

N&C Five Knuckle Brass Hinges DSSW

- Five knuckle brass hinge
- Double stainless steel washers

Code	Size	Finish
H8011026	76x50x3mm	Polished Brass
H8011027	102x67x3mm	Polished Brass
H8011028	102x76x3mm	Polished Brass



N&C Five Knuckle Brass Hinges

- Five Knuckle Solid Drawn Brass Hinge

Code	Size	Finish
H8011031	102x60mm	Self Colour Brass
H8011029	76x40mm	Self Colour Brass
H8011030	102x76mm	Self Colour Brass
H8021004	50x30mm	Polished Chrome
H8021005	60x34mm	Polished Chrome
H8021006	75x41mm	Polished Chrome
H8021007	102x60mm	Polished Chrome



N&C Parliament Brass Hinges

- Five Knuckle Solid Drawn Brass Parliament Hinge

Code	Size	Finish
H8011009	102x102x3mm	Polished Brass
H8011010	102x125x3mm	Polished Brass
H8011011	102x152x3mm	Polished Brass
H8021008	102x102x3mm	Polished Chrome
H8021010	102x152x3mm	Polished Chrome



N&C Projection Brass Hinges

N&C Projection Brass Hinges are drilled with holes towards the edge of a broad hinge leaf enabling the hinge to clear obstructions when fully opened beyond 90°

N&C Projection Brass Hinges

- Five Knuckle Solid Drawn Brass Projection Hinge
- Double Stainless Steel Washers

Code	Size	Finish
H8011032	102x102x3mm	Polished Brass
H8011033	102x125x3mm	Polished Brass
H8011034	102x152x3mm	Polished Brass

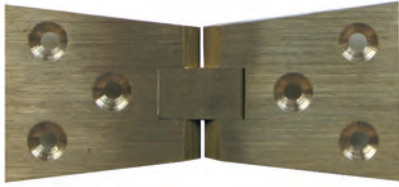

N&C Counterflap Brass Hinges

• Brass Counterflap Hinge

Code	Size	Finish
H0453501	75x25mm	Self Colour Brass



N&C Counterflap Catch

• Brass counterflap catch

Code	Size	Finish
H0454001	35x22mm	Polished Brass



N&C Heavy Duty Continuous Hinge

• Continuous heavy duty stainless steel hinge

Code	Size	Finish
H0452507	2000x75x2.5mm	Stainless Steel
H0452508	2134x100x2.5mm	Stainless Steel

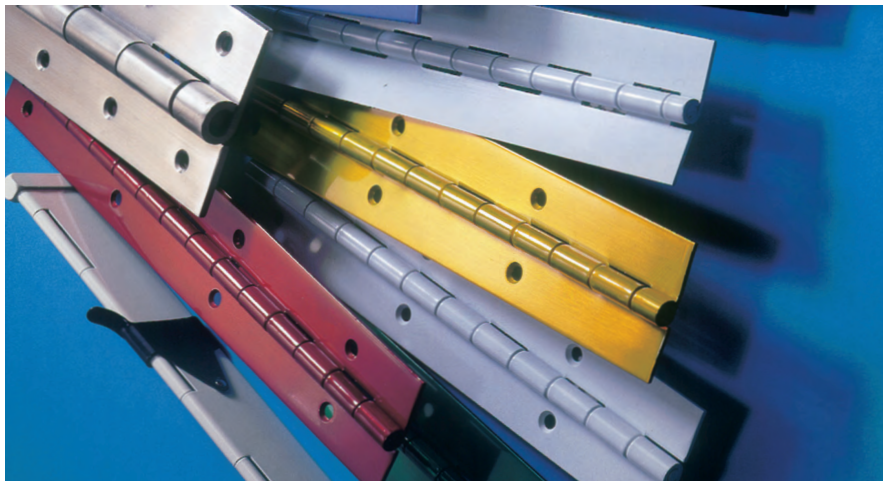

N&C Steel Piano Hinge

• Continuous steel piano hinge • 0.66mm thickness

Code	Size	Finish
H0452501	1800x25mm	Electro Brass
H0452503	1800x32mm	Electro Brass
H0452505	1800x38mm	Electro Brass
H0452502	1800x25mm	Nickel Plated
H0452504	1800x32mm	Nickel Plated
H0452506	1800x38mm	Nickel Plated



Concealed Soss Brass Hinges

• Pattern 203

Code	Door Thickness	Finish
H0453001	19mm	Self Colour Brass

• Pattern 208

Code	Door Thickness	Finish
H0453011	70x16mm	Self Colour Brass

• Pattern 216

Code	Door Thickness	Finish
H0453021	117x25mm	Self Colour Brass

• Pattern 218

Code	Door Thickness	Finish
H0453031	117x28mm	Self Colour Brass

• Pattern 220

Code	Door Thickness	Finish
H0453041	140x35mm	Self Colour Brass

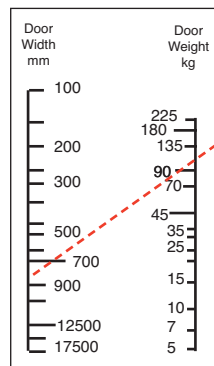

Choosing the right Soss hinge

Firstly determine the width, thickness and weight of the door. Then draw a straight line on the chart, starting on the left hand side at the appropriate point on the door weight column to end at line A

Example

A door 760mm wide that weighs 90kg and has a thickness of 41mm would require four Soss hinges No. 218. The dotted red line shows how this result was determined from the chart

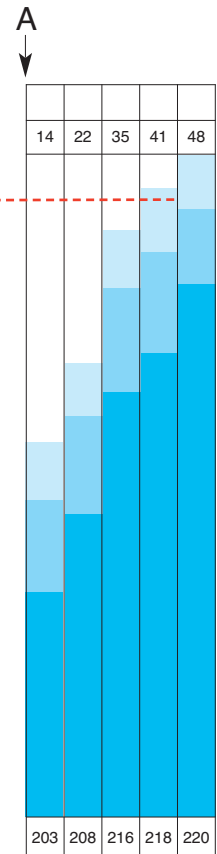

Gate Hinges

A range of traditional steel hinges for a variety of applications from gates, sheds, stores, trestles and cellar hatches outside pubs.



N&C Steel Tee Hinges Medium Weight

● Medium weight steel tee hinges

Code	Size	Finish
H0460001	230mm	Japanned
H0460011	300mm	Japanned
H0460021	375mm	Japanned
H0460031	450mm	Japanned



N&C Steel Tee Hinges Heavy Weight

● Heavy Weight Steel Tee Hinge

Code	Size	Finish
H0460551	300mm	Galvanised
H0460561	450mm	Galvanised
H0460571	600mm	Galvanised

N&C Steel Strap Hinges

● Straight steel strap hinges

Code	Size	Finish
H0461001	152mm	Self Colour Steel
H0461011	203mm	Self Colour Steel
H0461021	305mm	Self Colour Steel

N&C Steel Reversible Hinges

● Light pattern steel reversible hinges

Code	Size	Finish
H0461501	254mm	Self Colour Steel
H0461511	305mm	Self Colour Steel
H0461521	406mm	Self Colour Steel
H0461531	457mm	Self Colour Steel
H0461541	610mm	Self Colour Steel



N&C Steel Reversible Hinges

● Heavy pattern steel reversible hinges ● Heavy pattern

Code	Size	Finish
H0462001	457mm	Self Colour Steel
H0462011	610mm	Self Colour Steel
H0462021	760mm	Self Colour Steel
H0462031	914mm	Self Colour Steel

N&C Hook & Ride Hinges

● Wrought iron hinges ● Hook on screw fix plates

Code	Size	Finish
H0463001	305mm	Self Colour
H0463011	405mm	Self Colour
H0463021	457mm	Self Colour
H0463031	610mm	Self Colour

N&C Cellar Flap Hinges

● Wrought iron cellar flap hinge

Code	Size	Finish
H0463501	457mm	Self Colour

Spring Hinges

N&C architectural single action spring hinges can be used where clients would normally fit jamb mounted concealed door closers and hinges.

N&C double action and single action hinges are ideal for kitchens, restaurants, public houses, although it is advisable to note that there is no control or check action with these hinges.



N&C Architectural Single Action Spring Hinges

- Adjustable steel single action (Set Of 3)
- Max door weight 60kg

Code	Size	Finish
H8700160	102x76x2.7mm	Polished Chrome
H8700161	102x76x2.7mm	Satin Chrome
H8700162	102x76x2.7mm	Electro Brass Plated

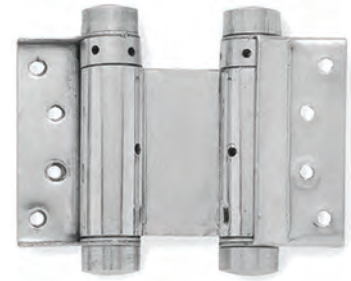

N&C Double Action Spring Hinges

- Max door weight 40Kg
- Max door width 750mm
- Door thickness 35-40mm

Code	Size	Finish
H8700011	75mm	Silver Sprayed
H8700111	75mm	Brass



N&C Double Action Spring Hinges

- Max door weight 15kg
- Max Door width 600mm
- Door thickness 18-25mm

Code	Size	Finish
H8700012	102mm	Silver Sprayed
H8700112	102mm	Brass

N&C Double Action Spring Hinges

- Max door weight 22kg
- Max door width 700mm
- Door thickness 25-30mm

Code	Size	Finish
H8700013	127mm	Silver Sprayed
H8700113	127mm	Brass

N&C Double Action Spring Hinges

- Max door weight 27kg
- Max door width 700mm
- Door thickness 30-35mm

Code	Size	Finish
H8700014	152mm	Silver Sprayed
H8700114	152mm	Brass

N&C Double Action Spring Hinges

- Max door weight 55kg
- Max door width 850mm
- Door thickness 40-45mm

Code	Size	Finish
H8700015	178mm	Silver Sprayed



N&C Single Action Spring Hinges

- Max door weight 15kg
- Max Door width 600mm
- Door thickness 18-25mm

Code	Size	Finish
H8700001	75mm	Silver Sprayed
H8700101	75mm	Brass

N&C Single Action Spring Hinges

- Max door weight 22kg
- Max door width 700mm
- Door thickness 25-30mm

Code	Size	Finish
H8700002	102mm	Silver Sprayed
H8700102	102mm	Brass

N&C Single Action Spring Hinges

- Max door weight 27kg
- Max door width 700mm
- Door thickness 30-35mm

Code	Size	Finish
H8700003	127mm	Silver Sprayed
H8700103	127mm	Brass

N&C Single Action Spring Hinges

- Max door weight 40kg
- Max door width 750mm
- Door thickness 35-40mm

Code	Size	Finish
H8700004	152mm	Silver Sprayed
H8700104	152mm	Brass

N&C Window Hinges

N&C window hinges include cranked casement hinges that accommodate the weatherproofing joinery detail on timber windows and easy clean hinges that open to an angle that allows cleaning from the inside with a friction stay option.

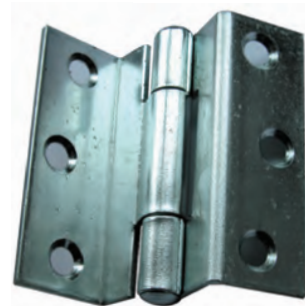

N&C Stormproof Casement Hinges

- Cranked Stormproof Hinge

Code	Size	Finish	
H0455501	65mm	Steel	Bright Zinc Plated
H8011005	65mm	Brass	Self Colour Brass



N&C Easy Clean Hinges

- Easy Clean Steel Window Hinge ● 16mm Projection

Code	Leg	Hand	Finish
H0452101	100mm	Left	Sheradised
H0452102	100mm	Right	Sheradised



N&C Friction Stay Hinges Side Hung

- Stainless Steel Friction Stay ● Max Casement Weight 22Kg
- Hinge For Side Hung Casement

Code	Size	Finish
H0535701	305mm	Stainless Steel



N&C Friction Stay Hinges Top Hung

- Stainless Steel Friction Stay ● Max Casement Weight 16Kg
- Hinge For Top Hung Casement

Code	Size	Finish
H0535711	305mm	Stainless Steel

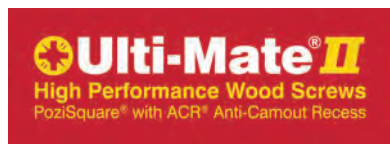

STATE OF THE ART POZISQUARE® AND ACR® ANTI-CAMOUT RECESS FOR 'STICK-FIT' AND 'STABLE DRIVING'

- REINFORCED DOUBLE ANGLE HEAD**
Self countersinking and resistant to screw breakage
- SELF CENTERING POZISQUARE® RECESS**
Will also drive with PH and PZ Drivers
- STRONG SHANK**
Tempered high quality steel
- OPTIMALLY ANGLED WAXED THREADS**
Faster and easier to drive
- SLOTTED SHANK**
For reduced wood splitting
- NEW QUICK-START POINT**
Rapid starting with a minimum of force

Ulti-Mate II also features: ● TOUGHER NECK ● ZINC & YELLOW PLATED ● NO RIBS ON SMALLER SIZES suitable for hinges and fittings

For more information on fixings please contact our team of ironmongery specialists.

Door Closers & Controls

We offer architectural quality door closers and controls for everyday projects suitable for domestic and commercial situations, as well as doors suitable for accessibility with varying options dependent on usage, volume of traffic and environment. Where appropriate, our door closers meet British and European Standards and testing methods to BS EN 1154 and for electro magnetically controlled products to BS EN 1155.

OVERHEAD DOOR CLOSERS

We offer a complete range of N&C door closers that cover all possible applications along with known brands such as Dorma and Briton.

FLOOR SPRINGS

The perfect choice for heavier doors where the closing mechanism is mounted within the floor

TRANSOM CLOSURES

Transom door closers are normally used throughout the shopfitting industry as they lend themselves to the Aluminium and Stainless Steel profiles for shopfronts.



WHICH DOOR CLOSER TO USE?

Frequency of Use

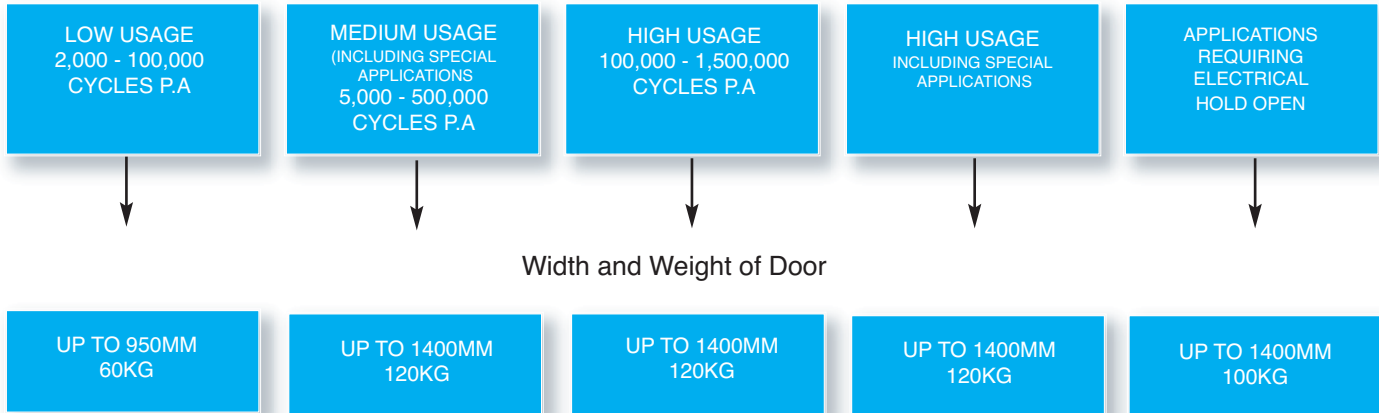

WHICH DOOR CLOSER CONFIGURATION TO USE?

Overhead door closers can generally be fixed in one of three ways depending on the door location. Most door closers are supplied with necessary brackets and fixings to enable them to be fitted in any of the applications with universal fittings.

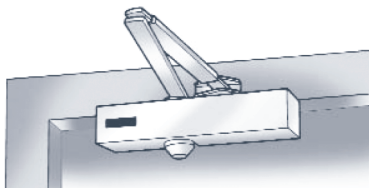

Regular fixing

Closer body mounted on the pull face of the door

Fig 1

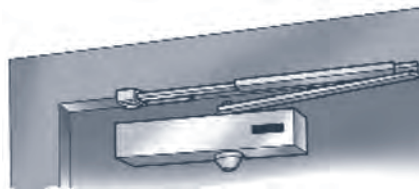

Parallel Fixing

Closer body mounted on the push side of the door

Fig 66

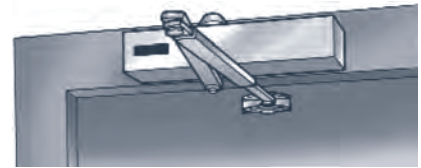

Transom fixing

Closer body mounted on the transom on the push side of the door

Fig 61



CE MARK EXPLAINED

Door closers are an important link in the control of fire and smoke and their usage can help save lives. From October 2004 Door Closer standards, EN 1154 and EN 1155 became harmonised across Europe and are now the required standards to test to in order to attain CE marking for controlled door closing devices.



UNDERSTANDING THE TERMINOLOGY

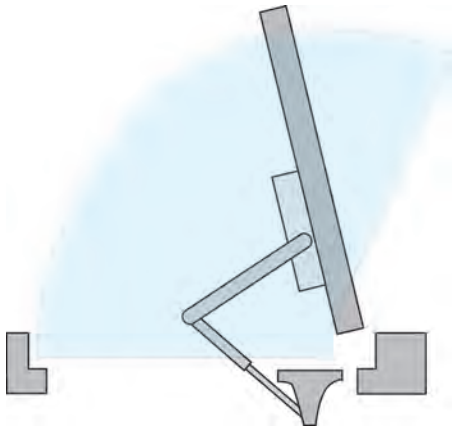

Back Check

The in built cushioning during the opening cycle that helps minimise the risk of personal injury and damage to adjacent walls

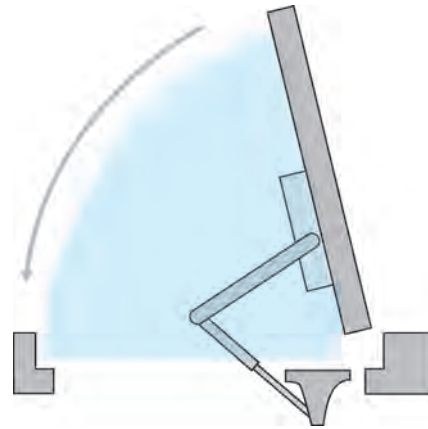

Delayed Closing Action

Delays the closing cycle to allow slow moving pedestrians to pass through unhindered by the closing door

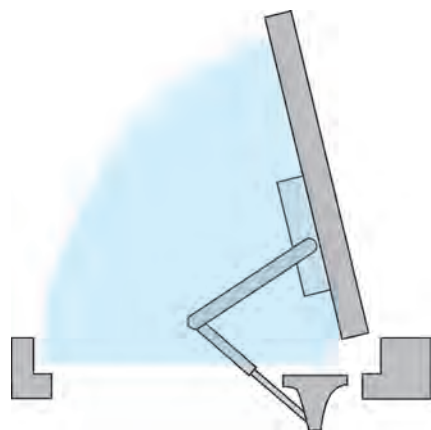

Hold Open

A device to enable the closer to be held in the open position (usually 90 degrees), These closers must not be used on fire doors (except where they are electronically controlled)

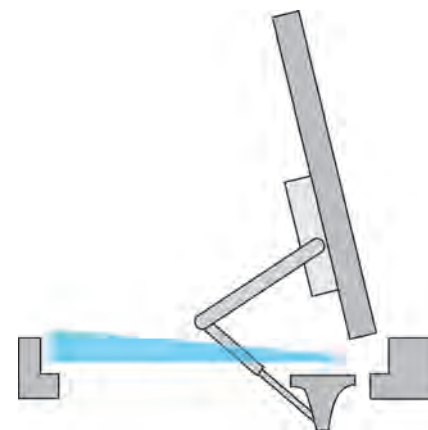

Latching action

The door movement becomes accelerated in the last degrees of closing to overcome any resistance such as seals, latch bolts etc.

THE EQUALITIES ACT - DISABILITY LEGISLATION

Legislation aimed at providing universal accessibility of buildings requires service providers to make "reasonable adjustments to the physical features of their premises to overcome barriers to access".

Approved Doc M of the Building Regulations and BS 8300 provide guidance in establishing recommended opening forces for door controls to assist less able users.

Our high efficiency door closers that are capable of meeting the required levels of opening and closing forces. They are marked with the "Wheelchair Symbol". Accurate installation, hinge friction, door seals and variable air pressure can all have a bearing on the opening resistance of the final doorset.

For doors which must also meet the stringent closing force requirements for fire door applications, it may be more appropriate to use electromagnetic hold open or swing free closers or a powered opening solution.





N&C Overhead Door Closer BS EN Size 3

- Door closer fixed closing force 3
 - Max door width 950mm • Max door weight 60kg
 - 120 minute fire rated • Matching arm & cover
- Fig 1, 61 & 66

Code	Body	Finish
H0412517	180x42x64mm	Silver Sprayed



N&C Overhead Door Closer BS EN Size 2-4

- Backcheck & delayed closing action
 - Variable closing force 2-4 • Adjustment by position
 - Max door width 1100mm • Max door weight 80kg
 - 120 minute fire rated • Matching arm & cover
- fig 1, 61 & 66

Code	Body	Finish
H0412508	248x42x52mm	Silver Sprayed
H0412509	248x42x52mm	Satin Stainless Steel
H0412510	248x42x52mm	Polished Stainless Steel
H0412516	248x42x52mm	Polished Brass



N&C Overhead Door Closer BS EN Size 2-5

- Slimline closer with backcheck & delayed closing action
 - Variable closing force 2-5 • Adjustment by spring
 - Max door width 1250mm • Max door weight 100kg
 - 120 minute fire rated • Matching arm & cover
- fig 1, 61 & 66

Code	Body	Finish
H0412523	236x55x38mm	Silver Sprayed
H0412524	236x55x38mm	Satin Stainless Steel
H0412525	236x55x38mm	Polished Stainless Steel
H0412526	236x55x38mm	Polished Brass



N&C Overhead Slimline Door Closer BS EN Size 3-6

- Slimline closer with backcheck & delayed closing action
 - Variable closing force 3-6 • Adjustment by spring
 - Max door width 1250mm • Max door weight 100kg
 - 120 minute fire rated • Matching arm & cover
- fig 1, 61 & 66

Code	Body	Finish
H0412518	236x55x38mm	Silver Sprayed
H0412519	236x55x38mm	Satin Stainless Steel
H0412520	236x55x38mm	Polished Stainless Steel
H0412521	236x55x38mm	Polished Brass



N&C Overhead Slimline Cam Action Door Closer BS EN Size 2-4

- Slimline closer with backcheck & delayed closing action
 - Variable closing force 2-4 • Adjustment by spring
 - Max door width 950mm • Max door weight 60kg
 - 120 minute fire rated • Matching arm & cover
- Fig 1, 61 & 66

Code	Body	Finish
H0412528	210x52x36mm	Silver Sprayed
H0412529	210x52x36mm	Satin Stainless Steel
H0412525	210x52x36mm	Polished Stainless Steel
H0412527	210x52x36mm	Polished Brass



N&C Overhead Door Closer With Electro Magnetic Function BS EN Size 4

- Electro magnetic hold open/swing free function
 - Size 4 closing force • Adjustment by position
 - Max door width 1100mm • Matching arm & cover
- fig 1, 61 & 66

Code	Body	Finish
H0412536	290x553x60mm	Silver Sprayed
H0412537	290x553x60mm	Satin Stainless Steel
H0412538	290x553x60mm	Polished Stainless Steel
H0412539	290x553x60mm	Polished Brass

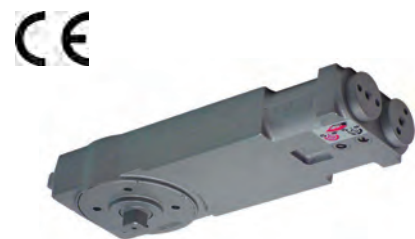

N&C Transom Mounted Concealed Door Closer BS EN Size 3

- Concealed transom mounted double action door closer
- Size 3 closing force • Max door width 950mm
- Bottom pivot and side load arm

Code	Body	Finish
H0412556	271x87x40mm	N/A



N&C Jamb Mounted Concealed Door Closer

- Concealed jamb fixing door spring
- Max door weight 50kg • Square plate

Code	Barrel	Plate	Finish
H0412508	138x22mm	51x25mm	Nickel Plated
H0430501	138x22mm	51x25mm	Brass

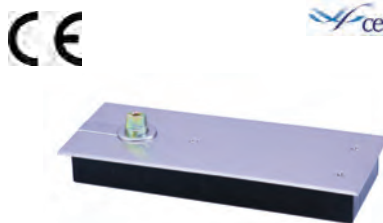

N&C Single Action Floor Spring BS EN Size 3

- Heavy duty floor spring non hold open mechanism
- Back check • Size 3 closing force
- Max door width 950mm • Single action accessories & matching cover plate

Code	Body	Hand	Finish
H0412540	306x108x40mm	Left	Satin Stainless Steel
H0412541	306x108x40mm	Right	Satin Stainless Steel
H0412542	306x108x40mm	Left	Polished Brass
H0412543	306x108x40mm	Right	Polished Brass



N&C Double Action Floor Spring BS EN Size 3

- Heavy duty floor spring non hold open mechanism
- Back check ● Size 3 closing force
- Max door width 950mm ● Double action accessories & matching cover plate

Code	Body	Finish
H0412544	306x108x40mm	Satin Stainless Steel
H0412545	306x108x40mm	Polished Brass



N&C Single Action Floor Spring BS EN Size 4

- Heavy duty floor spring non hold open mechanism
- back check ● Single action accessories & matching cover
- Size 4 closing force ● Max door width 1100mm plate

Code	Body	Hand	Finish
H0412546	306x108x40mm	Left	Satin Stainless Steel
H0412547	306x108x40mm	Right	Satin Stainless Steel
H0412548	306x108x40mm	Left	Polished Brass
H0412549	306x108x40mm	Right	Polished Brass



N&C Double Action Floor Spring BS EN Size 4

- Heavy duty floor spring non hold open mechanism
- Size 4 closing force ● Max door width 1100mm
- Back check ● Double action accessories & matching cover plate

Code	Body	Finish
H0412544	306x108x40mm	Satin Stainless Steel
H0412551	306x108x40mm	Polished Brass



N&C Single Action Floor Spring With Electro Magnetic Function BS EN Size 4

- Electro magnetic hold open mechanism
- Size 4 closing force ● Max door width 1100mm
- Single action accessories & matching cover plate

Code	Body	Finish
H0412552	307x78x60mm	Satin Stainless Steel
H0412553	307x78x60mm	Polished Brass



N&C Double Action Floor Spring With Electro Magnetic Function BS EN Size 4

- Electro magnetic hold open mechanism
- Size 4 closing force ● Max door width 1100mm
- Double action accessories & matching cover plate

Code	Body	Finish
H0412554	307x78x60mm	Silver Sprayed
H0412555	307x78x60mm	Polished Brass



N&C Door Selector

- N&c overhead "wedge" pattern door selector
- ensures correct closing sequence on a pair of rebated double doors

Code	Finish
H0432002	Satin Stainless Steel



Dorgard Door Holder

- Dorgard acoustic fire door retainer ● Battery operated
- Doors released upon activation of fire alarm when used in conjunction with a suitable door closing device

Code	Body	Finish
H0410512	205x195mm	White
H0410513	205x195mm	Black
H0410514	205x195mm	Red
H0410515	205x195mm	Brown
H0410516	205x195mm	Oak

Code	Body	Finish
H0410517	205x195mm	Beech
H0410518	205x195mm	Ash
H0410519	205x195mm	Mahogany
H0410520	205x195mm	Aluminium
H0410521	205x195mm	Brass

Why Use Dorgard Door Holders?

Dorgard is an intelligent fire door hold-open device that listens for a continuous fire alarm sound level of over 65 decibels.

After approximately 14 seconds, Dorgard releases allowing the fire door to close under the pressure of the overhead door closure.

Dorgard is accepted for use by fire authorities and complies fully with all relevant British Standards, EC Directives and UK Workplace Regulations (Fire Precautions) 1997 CE rated.



Briton Door Closers & Controls



Our range of Briton overhead door closers and controls offer our clients a multi-level approach to suit projects of all types, door applications and budgets. Briton have been supplying high quality, highly engineered products designed for longevity and performance for well over 100 years.



Briton 121CE Door Closer

- Overhead door closer
- Fixed closing force 3
- Max door width 950mm
- Screwthread armset
- Fig 1 & 61

Code	Body	Finish
H0412535	181x40x63mm	Silver



Briton 1110 Door Closer

- Overhead door closer
- Variable closing force 2-4
- Adjustment by position
- Max door width 1100mm
- Screwthread armset and trimplate cover
- Fig 1, 61 & 66

Code	Body	Finish
H0411101	207x60x38mm	Silver



Briton 1110.C Door Closer

- Overhead door closer
- Variable closing force 2-4
- Adjustment by position
- Max door width 1100mm
- Flat form armset and matching cover
- Fig 1, 61 & 66

Code	Body	Finish
H0411103	207x60x38mm	Polished Stainless Steel
H0411104	207x60x38mm	Satin Stainless Steel



Briton 1120.B Door Closer

- Overhead door closer
- Variable closing force 2-4
- Adjustment by spring
- Max door width 1100mm
- Screwthread armset and trimplate cover
- Fig 1, 61 & 66

Code	Body	Finish
H0412504	236x60x38mm	Silver



Briton 2003 Door Closer

- Overhead door closer
- Fixed closing force 3
- Fixed closing force 3
- Max door width 950mm
- Flat form armset matching cover
- Fig 1, 61 & 66

Code	Body	Finish
H0412501	249x48x59mm	Silver
H0412503	249x48x59mm	Polished Brass



Briton 2003V Door Closer

- Overhead door closer with adjustable backcheck
- Variable closing force 1-4
- Adjustment by spring
- Max door width 1100mm
- Flat form armset matching cover
- Fig 1, 61 & 66

Code	Body	Finish
H0413901	249x48x59mm	Silver



Briton 2003T Door Closer

- Overhead slide track door closer
- Fixed power force 3
- Max door width 950mm
- Matching cover and slide track
- Fig 1 & 61

Code	Body	Finish
H0413701	249x48x59mm	Silver



Briton 2004 Door Closer

- Overhead door closer
- Fixed closing force 4
- Adjustment by position
- Max door width 1100mm
- Flat form armset and matching cover
- Fig 1, 61 & 66

Code	Body	Finish
H0413001	249x48x59mm	Silver
H0413003	249x48x59mm	Polished Brass



Briton 2130B.C Door Closer

- Overhead door closer with backcheck
- Variable power force 2-6
- Adjustable by spring
- Max door width 1400mm
- Flat form armset matching cover
- Fig 1, 61 & 66

Code	Body	Finish
H0413501	310x55x66mm	Silver
H0413503	310x55x66mm	Polished Brass



Briton 2130BD.C Door Closer

- Overhead door closer with backcheck and delayed action
- Variable power force 2-6
- Adjustable by spring
- Max door width 1400mm
- Flat form armset matching cover
- Fig 1, 61 & 66

Code	Body	Finish
H0413601	310x55x66mm	Silver
H0412603	310x55x66mm	Polished Brass



Briton 2130B.T.C Door Closer

- Overhead slide track door closer with backcheck
- Delayed closing action
- Variable power force 2-4
- Adjustable by spring
- Max door width 1100mm
- Matching cover & slide track
- Fig 1 & 61

Code	Body	Finish
H0413801	310x55x66mm	Silver



Briton 9963/01 Overhead Door Closer With Electro Magnetic Function

- Overhead door closer with electro magnetic hold open/swing free function
- Size 3 closing force
- Max door width 950mm
- Black arm & silver cover
- Fig 1 & 61

Code	Body	Finish
H0410501	305x64x92mm	Silver



Briton 9963/66 Overhead Door Closer With Electro Magnetic Function

- Overhead door closer with electro magnetic hold open/swing free function
- Size 3 closing force
- Max door width 950mm
- Black arm & silver cover
- Fig 66

Code	Body	Finish
H0410511	305x64x92mm	Silver



Briton 2130B.TE.C Overhead Door Closer With Electro Magnetic Hold Open Function

- Overhead slide track closer with electro magnetic hold open
- Adjustable backcheck
- Variable power force 3-4
- Max door width 1100mm
- Matching cover & slide track
- Fig 1

Code	Body	Finish
H0410601	310x55x66mm	Silver



Briton 533 Electro Magnetic Hold Open Device

- Wall mounted electro magnetic hold open device
- Built in release/test button doors
- Released upon activation of fire alarm when used in conjunction with a suitable door closing device

Code	Finish
H0409001	Silver



Briton 533C Surface Box

- Surface box mount
- (Converts 533 from flush mounted to surface mounted)

Code	Finish
H0409002	Silver



Dorma Door Closers & Controls

Dorma's design oriented range includes quality door closers, access solutions and accessories perfect for commercial and domestic projects implemented across all industries.



Dorma TS68 Overhead Door Closer

- Overhead door closer
- Adjustable power force 2-4
- Adjustment by position
- Max door width 1100mm
- Screwthread armset
- Fig 1, 61 & 66

Code	Body	Finish
H0421501	220x54x45mm	Silver



Dorma TS71 Overhead Door Closer

- Overhead door closer
- Adjustable power force 3-4
- Adjustment by position
- Max door width 1100mm
- Trimplate cover and matching screwthread armset
- Fig 1, 61 & 66

Code	Body	Finish
H0421001	232x68x45mm	Silver



Dorma TS72V Overhead Door Closer

- Overhead door closer
- Adjustable power force 2-4
- Adjustment by spring
- Max door width 1100mm
- Trimplate cover and matching screwthread armset
- Fig 1, 61 & 66

Code	Body	Finish
H0421600	232x68x45mm	Silver



Dorma TS72VBC Overhead Door Closer

- Overhead door closer
- adjustable backcheck
- Adjustable power force 2-4
- Max door width 1100mm
- Trimplate cover and matching screwthread Armset
- Fig 1, 61 & 66

Code	Body	Finish
H0421601	232x68x45mm	Silver



Dorma TS73V Overhead Door Closer

- Overhead door closer with backcheck
- Variable closing force 2-4
- Adjustment by spring
- Max door width 1100mm
- Trimplate cover and matching screwthread armset
- Fig 1, 61 & 66

Code	Body	Finish
H0421701	225x40x45mm	Silver



Dorma TS90 Overhead Door Closer

- Cam action overhead slide track door closer
- Fixed power force 3
- Max door width 950mm
- Full cover, matching slide channel & arm
- Fig 1

Code	Body	Finish
H0422200	246x57x46mm	Silver



Dorma TS91 Overhead Door Closer

- Cam action overhead slide track door closer
- Fixed power force 3
- Max door width 950mm
- Body & cover only
- Fig 1

Code	Body	Finish
H0421901	267x65x47mm	Silver



Dorma TS92B Overhead Door Closer (Pull Side)

- Cam action overhead slide track door closer
- Adjustable power force 1-4 • Adjustment by spring
- Max door width 1100mm • Body & cover only
- Fig 1

Code	Body	Finish
H0421801	281x65x47mm	Silver



Dorma TS92B Overhead Door Closer (Push Side)

- Cam action overhead slide track door closer
- Adjustable power force 1-4 • Adjustment by spring
- Max door width 1100mm • Body & cover Only
- Fig 6

Code	Body	Finish
H0421803	281x65x47mm	Silver



Dorma TS93B Overhead Door Closer

- Cam action overhead slide track door closer
- Adjustable power force 2-5 • Adjustment by spring
- Max door width 1250mm • Body & cover only
- Fig 1

Code	Body	Finish
H0422501	285x62x53mm	Silver



Dorma G-N Arm & Channel

- Slide arm & channel to suit TS91/92/93 cam action overhead slide track door closer

Code	Body	Finish
H0422601	428x35mm	Silver



Dorma G-N Angle Bracket

- Angle bracket for push side of door (For use with slide arm & channel (for push side of door))

Code	Body	Finish
H0422602	428x25mm	Silver



Dorma ITS96 Overhead Door Closer

- Concealed cam action overhead door closer
- Adjustable power force 2-4 • Adjustment by spring
- Body only • Fig 1

Code	Body
H0422701	256x40x51mm

Dorma ITS96 Intumescent Pack

Code	Finish
H0422705	N/A



Dorma ITS96 Arm & Channel

- To suit 2-4 ITS96 concealed cam action overhead closer

Code	Finish
H0422702	Silver



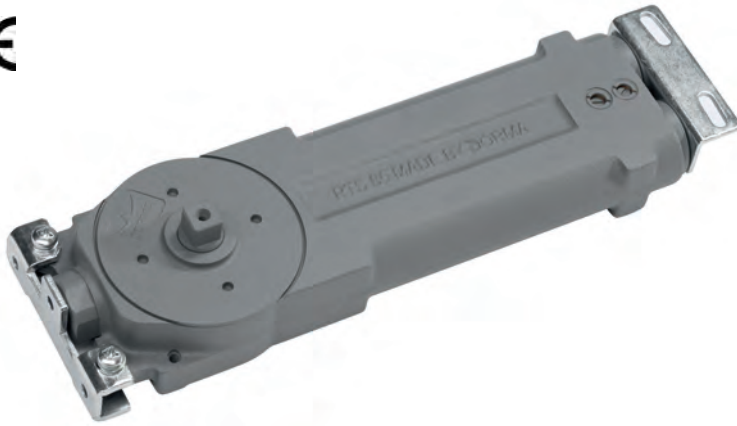

Dorma 8550/1 Side Load Floor Pivot

- For door bottom rail • Channel depth of up to 50mm

Code

H0423041

Dorma RTS85 Size 3 Non H/O Transom Closer

- Concealed transom mounted door closer
- Fixed power size 3 • Non hold open
- Standard spindle & brackets for 70mm pivot point

Code Body

H0423000 329x94x39mm

Dorma RTS85 Size 3 105 Deg H/O Transom Closer

- Concealed transom mounted door closer
- Fixed power size 3 • Max door width 950mm
- 105 degree hold open • Standard spindle & brackets for 70mm pivot point

Code Body

H0423003 329x94x39mm

Dorma RTS85 Size 4 Non H/O Transom Closer

- Concealed transom mounted door closer
- Fixed power size 4 • Max door width 1100mm
- Non hold open • Standard spindle & brackets for 70mm pivot point

Code Body

H0423011 329x94x39mm

Dorma RTS85 Size 3 90 Deg H/O Transom Closer

- Fixed power size 3 • Max door width 950mm
- 90 degree hold open • Standard spindle & brackets for 70mm pivot point

Code Body

H0423002 329x94x39mm



Dorma 8552/3 End Load Floor Pivot

- End load universal floor pivot for door bottom rail
- Channel depth of up to 50mm

Code

H0423042

Dorma RTS85 Size 4 90 Deg H/O Transom Closer

- Concealed transom mounted door closer
- Fixed power size 4 • Max door width 1100mm
- 90 degree hold open • Standard spindle & brackets for 70mm pivot point

Code Body

H0423012 329x94x39mm

Dorma RTS85 Size 5 Non H/O Transom Closer

- Concealed transom mounted door closer
- Fixed power size 5 • Max door width 1250mm
- non hold open • Standard spindle & brackets for 70mm pivot point

Code Body

H0423021 329x94x39mm



Dorma RTS85W Cover Plate

- Dorma RTS85W cover plate for timber door

Code

H0423051

Dorma RTS85 Size 5 90 Deg H/O Transom Closer

- Concealed transom mounted door closer
- Fixed power size 5 • Max door width 1250mm
- 90 degree hold open • Standard spindle & brackets for 70mm pivot point

Code Body

H0423022 329x94x39mm

Dorma RTS85 Size 5 105 Deg H/O Transom Closer

- Concealed transom mounted door closer
- Fixed power size 5 • Max door width 1250mm
- 105degree hold open • Standard spindle & brackets for 70mm pivot point

Code Body

H0423023 329x94x39mm



Dorma RTS85M Cover Plate

- Dorma RTS85M cover plate for metal door

Code

H0423052



Dorma 8530 Side Load Arm

- Dorma 8530 side load arm for RTS85 transom closer

Code Size

H0423031 38 x 15mm



Dorma 8534 End Load Arm

- Dorma 8534 end load arm for RTS85 transom closer

Code Body

H0423032 35 x 21mm



Dorma BTS75V Floor Spring

- Floor spring mechanism with backcheck
- Variable power 1-4 • for single & double action doors
- Max door width 1100mm • non hold open
- Standard spindle & cement box

Code	Body
H0425002	285x82x50mm



Dorma Double Action Accessory Pack For BTS75V Floor Spring

- Double action accessory pack for BTS75V floor spring
- Comprising: 8066 top centre, 7421 bottom strap, 7510 cover plate, fixings & installation instructions

Code	Finish
H0425005	Satin Stainless Steel Cover Plate
H0425006	Satin Brass Cover Plate



Dorma Single Action Accessory Pack For BTS75V Floor Spring

- Single accessory pack for BTS75V floor spring
- Comprising: 7411k/56f top centre, 7411/56 bottom strap, 7510 cover plate, fixings & installation instructions

Code	Finish
H0425003	Satin Stainless Steel Cover Plate
H0425004	Satin Brass Cover Plate



Dorma BTS80 Floor Spring

- Floor spring mechanism with backcheck
- Delayed closing action & hold open • Fixed power force 4
- Single & double action doors • max door width 1100mm
- Standard spindle & cement box

Code	Body
H0426002	341x78x60mm



Dorma Double Action Accessory Pack For BTS80 Floor Spring

- Double action accessory pack for BTS80 floor spring
- Comprising: 8066 top centre, 7421 bottom strap, 7510 cover plate, fixings & installation instructions

Code	Finish
H0426005	Satin Stainless Steel Cover Plate
H0426006	Satin Brass Cover Plate



Dorma Single Action Accessory Pack For BTS80 Floor Spring

- Single action accessory pack for BTS80 floor spring
- Comprising: 7411K/56F top centre, 7411/56 bottom strap, 7510 cover plate, fixings & installation instructions

Code	Finish
H0426003	Satin Stainless Steel Cover Plate
H0426004	Satin Brass Cover Plate



Dorma TS73EMF Overhead Door Closer With Electro Magnetic Function Size 4

- Overhead door close • Size 4 closing force
- Electro magnetic hold open/swing free function
- Max door width 1100mm
- Trimplate cover and matching armset
- Fig 1 & 61

Code	Size	Finish
H0427001	320x46x60mm	Silver



Dorma TS73EMF Overhead Door Closer With Electro Magnetic Function Size 5

- Overhead door close • Size 4 closing force
- Electro magnetic hold open/swing free function
- Max door width 1250mm
- Trimplate cover and matching armset
- Fig 1 & 61

Code	Size	Finish
H0427011	320x46x60mm	Silver



Dorma BTS80EMB Floor Spring With Electro Magnetic Function

- Floor spring mechanism • Fixed power force 4
- Backcheck & electro magnetic hold open function
- For single & double action doors • Cement box
- Max door width 1250mm • No spindle supplied

Code	Body
H0426021	341x78x75mm

Standard Spindle To Suit BTS80EMB Floor Spring	
H0426022	3mm Clearance



Powermatic Hydraulic Door Closer

- Concealed jamb mounted hydraulic door closer
- Adjustable closing speed & power latching action
- Fixed power force 3 • Max door width 950mm
- Max door weight 80kg

Code	Finish
H0431101	Brass
H0431102	Satin Chrome Plated
H0431105	Polished Chrome Plated



Perkomatic Hydraulic Door Closer

- Concealed jamb mounted hydraulic door closer
- Adjustable latching action
- For light to medium duty internal doors
- Max door weight 75kg

Code	Finish
H0431001	Brass
H0431002	Satin Chrome Plated
H0431005	Polished Chrome Plated



Perko Door Closer

- Concealed jamb mounted door closer
- For light to medium duty internal doors
- Max door weight 50kg

Code	Finish
H0430001	Brass
H0430002	Satin Chrome Plated
H0430005	Polished Chrome Plated



Door Closers & Controls Care and Maintenance

Overhead door closers

After fitting in accordance with the fitting instructions and template, the door closer must be adjusted to provide a smooth closing action. Adjustment should be made if necessary to allow the door to close against the resistance of a latch bolt where fitted using the "latch action" or in the instance of unlatched doors, against the doorstops with the "latch action" removed to avoid slamming. Where back check or delayed action facilities are incorporated, these should also be adjusted. Similarly the valve fitted to variable power units must be set according to the size of the door and the strength and ability of the user to operate the door. Further adjustments may be necessary during the commissioning and hand over stages as the hinges "wear in" and the closer mechanism adjusts to operating conditions. Where constantly variable air pressures exist, optimum performance cannot be guaranteed. It is recommended that doorstops be fitted to all non-back-check applications to prevent undue strain on the closer mechanism.

Floor springs

Floor springs single or double action, should be correctly installed to allow the door to align precisely in the doorframe in the closed position. Double action assemblies are designed to hold the door in the closed position at neutral, whereas single action accessories provide a 3 degree over-run to ensure that the door leaf is held positively against the door frame. Normally the universal spring unit should be fitted in line with the doorframe, but it may be fitted at 90 degrees to the doorframe provided the spindle insert is adjusted accordingly. Adjustments should be made to each control as appropriate to ensure a smooth and effective closing of the door. Additional adjustments may be necessary in the first few months after installation, as the door, frame and mechanism adjust to the prevailing conditions to achieve an acceptable action. A latch action facility is available for single action mode if required. In "wet" or external applications, the loose box should be filled with the manufacturers sealing compound. It is recommended that doorstops be fitted where possible to prevent undue strain on the spring mechanism.

Fire Control

Nicholls & Clarke offer a wide choice of fire control products for the safeguarding of properties assets and lives in both commercial and residential environments. From intumescent products that prevent the spread of fire, smoke and hot gases to extinguishers and blankets for attacking a fire.

A complete range of fire door exit hardware that assist in providing safe and effective escape completes the range. Our fire door exit hardware is rigorously tested to British and European Standard requirements and testing methods BS EN 1125 and BS EN 179.

BS EN 1125 covers exit devices operated by a horizontal bar for public environments that must provide safe and effective escape with a minimum of effort and without prior knowledge of operation i.e. cinema shopping centre, hospitals etc. BS EN 179 covers similar devices but operated by a lever handle or push pad but in non public environments where staff members of users are trained and therefore familiar with the operation.

CHOOSING A FIRE EXTINGUISHER

Fire Classification	Type of Fire	Suitable Fire Extinguisher Type
Class A Fires	Wood, paper, textiles	Water, Dry Powder, Foam
Class B Fires	Flammable liquids such as petrol, oil, fats and paints	Dry Powder, Foam
Class C Fires	Flammable gases such as Methane Acetylene and other natural or manufactured gases	Dry Powder
Electrical Fires	All types of electrical equipment	Carbon Dioxide



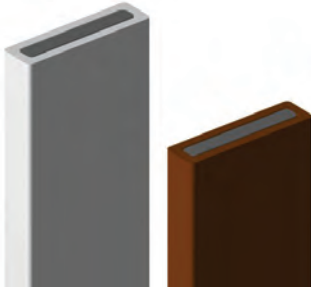

Intumescent Fire Seal

● Fire Only Seal

Code	Length	Size	Finish
H0850621	2100mm	10x4mm	White
H0850601	1050mm	10x4mm	White
H0850631	2100mm	10x4mm	Brown
H0850611	1050mm	10x4mm	Brown

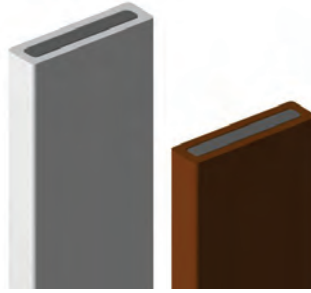

Intumescent Fire Seal

● Fire Only Seal

Code	Length	Size	Finish
H0850680	2100mm	15x4mm	White
H0850682	1050mm	15x4mm	White
H0850681	2100mm	15x4mm	Brown
H0850683	1050mm	15x4mm	Brown

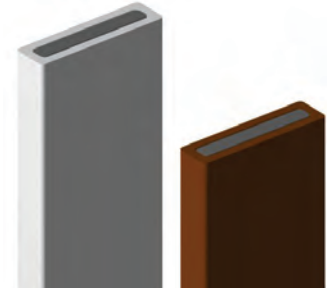

Intumescent Fire Seal

● Fire Only Seal

Code	Length	Size	Finish
H0850622	2100mm	20x4mm	White
H0850602	1050mm	20x4mm	White
H0850632	2100mm	20x4mm	Brown
H0850612	1050mm	20x4mm	Brown



Intumescent Fire & Cold Smoke Seal

● Fire & Cold Smoke Seal

Code	Length	Size	Finish
H0850661	2100mm	10x4mm	White
H0850641	1050mm	10x4mm	White
H0850671	2100mm	10x4mm	Brown
H0850651	1050mm	10x4mm	Brown



Intumescent Fire & Cold Smoke Seal

● Fire & Cold Smoke Seal

Code	Length	Size	Finish
H0850678	2100mm	15x4mm	White
H0850684	1050mm	15x4mm	White
H0850679	2100mm	15x4mm	Brown
H0850685	1050mm	15x4mm	Brown



Intumescent Fire & Cold Smoke Seal

● Fire & Cold Smoke Seal

Code	Length	Size	Finish
H0850662	2100mm	20x4mm	White
H0850642	1050mm	20x4mm	White
H0850672	2100mm	20x4mm	Brown
H0850652	1050mm	20x4mm	Brown



Intumescent Air Transfer Grilles

● Allows air to flow through under normal conditions but closes when exposed to fire

Code	Free Air Space	Thickness	Size
H0850717	15300mm sq	40mm	150x150mm
H0850718	16100mm sq	40mm	112x225mm
H0850719	30700mm sq	40mm	150x300mm
H0850720	32300mm sq	40mm	225x225mm
H0850721	61400mm sq	40mm	300x300mm



Louvre Ventilator

● To suit intumescent air transfer grilles

Code	To Suit	Size	Finish
H0850725	H0850717	200x197mm	Silver
H0850726	H0850718	160x270mm	Silver
H0850727	H0850719	196x344mm	Silver
H0850728	H0850720	269x269mm	Silver
H0850729	H0850721	340x346mm	Silver

Intumescents

In the event of fire an intumescent seal expands to many times its original volume to seal the gap around the door in order to provide a safe and effective barrier against fire, cold smoke and hot gasses.

Fire only seals are tested to BS 476 part 20/22

Fire and cold smoke seals are tested to BS476 part 20/22 and part 31.1

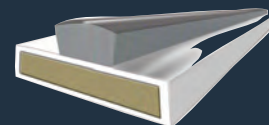



Intumescent Letter Plate

- Intumescent Letter Box Assembly • ABS Frame

Code	Size	Finish
H0850697	270x70mm	Silver Anodised

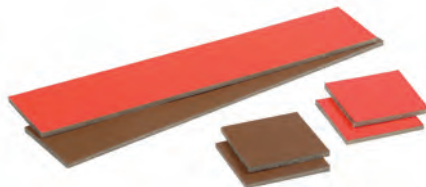

Intumescent Letter Box Liner

- Intumescent liner for letter box aperture in a timber door

Code	Max Aperture	Finish
H0850691	250x50mm	Red



Intumescent Hinge Pads

- Intumescent hinge pads pack of 6
- Easily trimmed to size

Code	Size
H0850690	300x36x2mm



Intumescent Paper Pack

Fire Officers specify intumescent protection to mortice locks and door closers. Intumescent paper expands rapidly in the event of a fire to provide additional protection to the mortice lock cavity as well as around the door closer, helping to maintain the integrity of the door.

- Intumescent paper pack for single door
- Comprises:
 - 3 Hinge Pads
 - 1 Mortice Lock Pad
 - 1 Overhead Door Closer Pad

Code
H0850692





For fire escape signage, please see 'Signage' section



Intumescent Glazing Tape

- 15 metre roll

Code	Size	Finish
H0850693	12x3mm	White



Intumescent Mastic

- Intumescent acrylic mastic

Code	Size	Finish
H0850694	310ml	White



Intumescent Foam

- Intumescent acoustic expanding foam

Code	Size
H0850695	750ml



Water Fire Extinguishers

- Water fire extinguisher

Code	Size	Finish
H0850801	6 Litre	Red
H0850811	9 Litre	Red



Dry Powder Fire Extinguishers

- Dry powder fire extinguisher

Code	Size	Finish
H0850821	4 Kg	Red



Foam Spray Fire Extinguishers

- Foam spray fire extinguisher

Code	Size	Finish
H0850831	6 Litre	Red
H0850841	9 Litre	Red

Replacement Fire Extinguisher Brackets

Wall brackets

H0850881	Water, Powder & Foam Spray Fire Extinguisher
----------	----------------------------------------------

Replacement Fire Extinguisher Brackets

Wall brackets

H0850881	Water, Powder & Foam Spray Fire Extinguisher
----------	----------------------------------------------

Replacement Fire Extinguisher Brackets

Wall brackets

H0850881	Water, Powder & Foam Spray Fire Extinguisher
----------	----------------------------------------------



Carbon Dioxide Fire Extinguishers

- Carbon dioxide fire extinguisher

Code	Size	Finish
H0850842	2 Kg	Red
H0850843	5 Kg	Red



Fire Blankets

- Wall mounted fire blanket

Code	Size	Finish
H0850851	1 x 1m	Red
H0850861	1.2 x 1.2m	Red
H0850871	1.8 x 1.2m	Red



Replacement Fire Extinguisher Brackets

Wall brackets

H0850891	Carbon Dioxide 2kg
H0850892	Carbon Dioxide 5kg



Break Glass Boxes

- Plastic emergency key box
- "Break Glass For Key"

Code	Dia	Finish
H0781501	127mm	Red



Emergency Key Box

- Lockable emergency key box with hinged door

Code	Size	Finish
H0782001	123x153x40mm	Red



Carbon Monoxide Alarm

- Battery operated

Code	Finish
H9924047	White

Spare Printed Glass

H0781511

Spare Glass

H0782002

Smoke Alarm

- Battery operated

Code	Finish
H9924046	White



N&C Single Door Panic Bolt

- 2 point locking • Integral anti thrust mechanism
- Supplied with easy clean socket • Non handed
- Max door height 2440mm • Max door width 1220mm

Code	Finish
H0403101	Silver



N&C Single Door Panic Latch

- 1 point locking • Integral anti thrust mechanism
- Supplied with adaptor for external rim cylinder
- Non handed • Max door width 1220mm

Code	Finish
H0403102	Silver



N&C Single Door Panic Nightlatch Actuator

- 1 point locking • Hold back • Anti thrust functions
- Suits euro profile single cylinder mortice nightlatch
- Non handed • Max door width 1220mm

Code	Finish
H0403103	Silver



N&C Rebated Double Door Panic Set

- 3 Point locking • Integral anti thrust mechanism
- Supplied with adaptor for external rim cylinder
- Easy clean socket & box keep
- Max door height 2440mm • Max door width 1220mm

Code	Finish
H0403100	Silver



N&C Single Door Pushpad Panic Bolt

- 2 point locking • Integral anti thrust mechanism
- Supplied with easy clean socket
- Max door height 2440mm • Non handed

Code	Finish
H0403105	Silver



N&C Single Door Pushpad Panic Latch

- 1 point locking • Integral anti thrust mechanism
- Supplied with adaptor for external rim cylinder
- Max door width 1220mm • Non handed

Code	Finish
H0403106	Silver



N&C Single Door Pushpad Panic Mortice Nightlatch and Actuator

- 1 point locking • Hold back & anti thrust functions
- Suits euro profile single cylinder mortice nightlatch
- Max door width 1220mm • Non handed

Code	Finish
H0403107	Silver



N&C Knob Operated Outside Access Device

- Integral 5 pin cylinder • 2 keys • Non handed

Code	Finish
H0403108	Silver



N&C Knob Operated Outside Access Device Euro Cylinder

- Includes replaceable euro profile single cylinder
- 3 keys (master keyed cylinders be introduced)
- Non handed

Code	Finish
H0403104	Silver





Briton 376 Single Door Panic Bolt

- 2 point locking • With easy clean socket
- Max door height 2500mm • Max door width 1300mm
- Non handed

Code	Finish
H0403001	Silver



Briton 377 Single Door Panic Latch

- 1 point locking • Integral anti thrust mechanism
- Adaptor for external rim cylinder
- Max door width 1300mm • Non handed

Code	Finish
H0404001	Silver



Briton 377 Rebated Double Door Panic Set

- 3 point locking • Integral anti thrust mechanism
- Adaptor for external rim cylinder
- Easy clean socket & box keep • Max door height 2500mm
- Max door width 1300mm • Non handed

Code	Finish
H0403601	Silver



Briton 379N Single Door Panic Nightlatch and Actuator

- 1 point locking • Suits euro profile single cylinder
- Mortice nightlatch has hold back & anti thrust functions
- Max door width 1300mm • Non handed

Code	Finish
H0404005	Silver



Briton 372 Single Door Pushpad Panic Bolt

- 2 point locking • Supplied with easy clean socket
- Max door height • Non handed

Code	Finish
H0404521	Silver



Briton 1438 Single Door Pushpad Panic Latch

- 1 point locking • integral anti thrust mechanism
- Adaptor for external rim cylinder • Non handed

Code	Finish
H0404501	Silver



Briton 389N Single Door Pushpad Panic Mortice Nightlatch

- 1 point locking • Suits euro profile single cylinder
- Mortice nightlatch has hold back & anti thrust functions
- Non handed

Code	Finish
H0404531	Silver



Briton 1413E/KE Outside Access Device Euro Cylinder

- Includes replaceable euro profile single cylinder
- 3 Keys (Master keyed cylinders be introduced)
- Non handed

Code	Finish
H0401001	Silver



Briton 1413E/LE Outside Access Device Euro Cylinder

- Includes replaceable euro profile single cylinder
- 3 Keys (master keyed cylinders be introduced)
- Non handed

Code	Finish
H0402001	Silver





Security Break Glass Door Bolt

- Break glass tube emergency door bolt
- Ceramic tube • Hammer, chain & padlock

Code	Size	Finish
H0146001	152x57mm	Silver

Replacement Ceramic Tube

H0146011



Fire Escape Mortice Deadlock 3 Lever

- 3 lever mortice escape deadlock

Code	Size	Finish
H0051501	76mm	Satin Chrome Plated
H0051502	76mm	Brass



Fire Escape Mortice Deadlock Euro Profile Cylinder

- Euro profile cylinder mortice • Escape deadlock case

Code	Size	Finish
H0055501	76mm	Satin Chrome Plated



Plastic Emergency "Break Glass Dome & Rose"

Code	Dia	Finish
H0055671	66mm	Clear Plastic

Replacement

H0055672	Plastic Emergency "Break Glass Dome" Only
H0055673	Plastic Emergency "Break Glass Dome" with integral thumbturn



"Break Glass Panel" Lever Operated Mortice Escape Deadlock

Code	Size	Type	Finish
H0055601	101mm	Lever	Satin Stainless Steel
H0055611	101mm	Euro	Satin Stainless Steel



Full "Break Glass Panel" Frame Mortice Key Pattern

- Suits H0055601 mortice lock

Code	Finish
H0055621	Green



Full "Break Glass Panel" Frame Euro Profile Cylinder Pattern

- Suits H00556011 mortice lock

Code	Finish
H0055631	Green



Standard "Break Glass Panel"

- Frame suits both H0055601 & H0055622 mortice locks

Code	Finish
H0055641	Green

Replacement Glass

H0055651	Glass Panel Printed Clear
----------	---------------------------



Mallet & Chain

- For "Break Glass Panel" mortice locks

Code	Finish
H0055661	Green

Please note: "break glass dome" & "break glass panel" mortice locks do not include domes, frames or panels. Frames do not include glass panels.

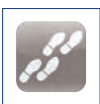

UNLEASH THE POWER

OX



Site Electrics



Makita Power Tools



Site Lighting



Signage

The International Standards Organisation (ISO) have sought to harmonise graphic symbols throughout the EU in order to gain a greater recognition of symbols within fire and safety signs. We offer a wide portfolio of compliant signs in braille, plastic, aluminium and self adhesive vinyl materials in a range of sizes.

ISO 7010/ BS 5499 and EC Directive fire exit signs should never be displayed together within the the same building. The use of ISO 7010 signs for escape routes and ISO 16069 for safety guidance helps ensure the evacuee is proceeds in the correct way to a place of safety.

CAUTION SIGNS

If there are hazardous areas or materials on your premises, it's essential to warn staff and visitors about them. One of the best ways to do this is by using Hazard Signs, which are widely understood and will help organisations to comply with the Health & Safety (Safety Signs and Signals) Regulations 1996.

EMERGENCY ESCAPE SIGNS

It is essential to have the correct emergency escape signage that clearly identifies escape routes with signs that conform to current UK and European legislation.

INFORMATION SIGNS

Information signs give visitors and employees within a premises a clear visual guidance. Our signs are ideal for display in warehouses, schools, offices and across many other industries where people would benefit from easy to understand instructions. We also offer a wide range of braille and tactile signs

CHOOSING THE RIGHT SIGN

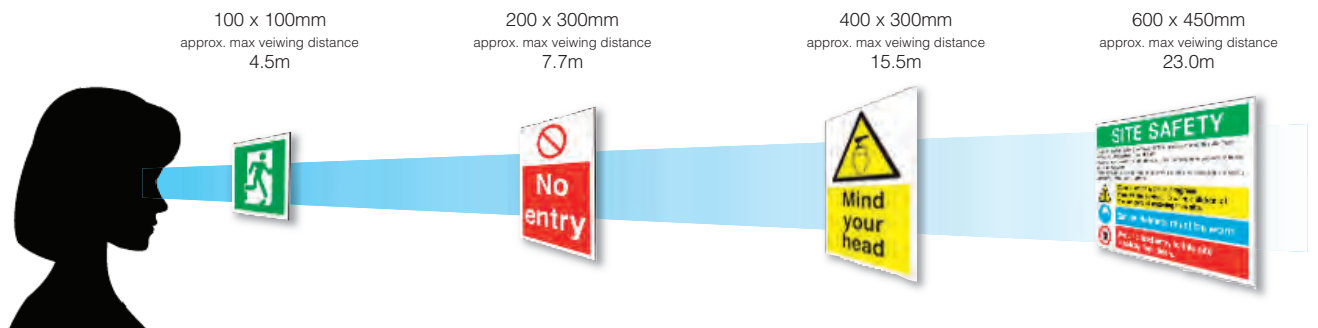

CLASSIFICATION OF SAFETY SIGNS



PROHIBITION
Must not do

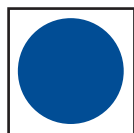

MANDATORY
Action, must do

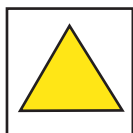

HAZARD
Danger, warning,
caution



SAFE CONDITIONS
Escape route,
safety equipment



FIRE



**SUPPLEMENTARY
INFO**
Action, must do



All signs with in this section are suitable for both commercial and education enviroments



Running Man Right

- Fire exit sign ● Rigid plastic ● Running man arrow to right

Code	Size	Finish
H6800001	400x150mm	White/Green
H6800002	600x200mm	White/Green



Running Man Left

- Fire exit sign ● Rigid plastic ● Running man arrow to left

Code	Size	Finish
H6800011	400x150mm	White/Green
H6800012	600x200mm	White/Green



Running Man Down

- Fire exit sign ● Rigid plastic ● Running man arrow down

Code	Size	Finish
H6800021	400x150mm	White/Green
H6800022	600x200mm	White/Green



Running Man Down Right

- Fire exit sign ● Rigid plastic ● Running man arrow diagonal down to right

Code	Size	Finish
H6800031	400x150mm	White/Green
H6800032	600x200mm	White/Green



Running Man Up Right

- Fire exit sign ● Rigid plastic ● Running man arrow diagonal up to right

Code	Size	Finish
H6800041	400x150mm	White/Green
H6800042	600x200mm	White/Green



Running Man Up

- Fire exit sign ● Rigid plastic ● Running man arrow up

Code	Size	Finish
H6800051	400x150mm	White/Green
H6800052	600x200mm	White/Green



Running Man Down Left

- Fire exit sign ● Rigid plastic ● Running man arrow diagonal down to left

Code	Size	Finish
H6800061	400x150mm	White/Green
H6800062	600x200mm	White/Green



Running Man Up Left

- Fire exit sign ● Rigid plastic ● Running man arrow diagonal up to left

Code	Size	Finish
H6800071	400x150mm	White/Green
H6800072	600x200mm	White/Green



Escape Route Signs

- Fire exit sign ● Rigid plastic

Code	Size	Finish
H6800081	150x150mm	White/Green
H6800082	200x200mm	White/Green



Escape Route Signs

- Fire exit sign ● Rigid plastic ● Running man arrow to left

Code	Size	Finish
H6800091	750x150mm	White/Green



Escape Route Signs

- Fire exit sign ● Rigid plastic ● Running man arrow to right

Code	Size	Finish
H6800092	750x150mm	White/Green



Running Man Exit

● Fire exit sign ● Rigid plastic ● Running man

Code	Size	Finish
H6800101	400x125mm	White/Green
H6800111	300x150mm	White/Green



Fire Assembly Point

● Fire assembly point sign ● Rigid plastic ● Collective group

Code	Size	Finish
H6800121	300x200mm	White/Green
H6800122	600x400mm	White/Green



Fire Assembly Point !

● Fire assembly point sign ● Rigid plastic ● Assembly point 1

Code	Size	Finish
H6800131	300x200mm	White/Green
H6800132	600x400mm	White/Green



Arrow

● Directional arrow sign ● Rigid plastic ● Straight

Code	Size	Finish
H6800142	150x150mm	White/Green
H6800143	200x200mm	White/Green



Diagonal Arrow

● Directional arrow sign ● Rigid plastic ● Diagonal

Code	Size	Finish
H6800151	125x125mm	White/Green
H6800152	150x150mm	White/Green



Running Man Right

● Exit sign ● Rigid plastic ● Running man arrow to right

Code	Size	Finish
H6800161	400x150mm	White/Green
H6800162	600x200mm	White/Green



Running Man Left

● Exit sign ● Rigid plastic ● Running man arrow to left

Code	Size	Finish
H6800171	400x150mm	White/Green
H6800172	600x200mm	White/Green



Running Man Down

● Exit sign ● Rigid plastic ● Running man arrow down

Code	Size	Finish
H6800181	400x150mm	White/Green
H6800182	600x200mm	White/Green



Running Man Up Right

● Exit sign ● Rigid plastic ● Running man arrow diagonal up to right

Code	Size	Finish
H6800191	400x150mm	White/Green
H6800192	600x200mm	White/Green



Running Man Up Left

● Exit sign ● Rigid plastic ● Running man arrow diagonal up to left

Code	Size	Finish
H6800201	400x150mm	White/Green
H6800202	600x200mm	White/Green



Running Man Up

● Exit sign ● Rigid plastic ● Running man arrow up

Code	Size	Finish
H6800211	400x150mm	White/Green
H6800212	600x200mm	White/Green



Running Man Down Right

● Exit sign ● Rigid plastic ● Running man arrow diagonal down to right

Code	Size	Finish
H6800221	400x150mm	White/Green
H6800222	600x200mm	White/Green



Running Man Down Left

- Fire exit sign ● Rigid plastic
- Running man arrow diagonal down to left

Code	Size	Finish
H6800231	400x150mm	White/Green
H6800232	600x200mm	White/Green



Break Glass For Key

- Fire action sign ● Rigid plastic ● Break glass for key

Code	Size	Finish
H6800241	100x150mm	White/Green



Break Glass For Latch

- Fire action sign ● Rigid plastic
- Break glass to reach latch

Code	Size	Finish
H6800242	100x150mm	White/Green



Break Glass

- Fire action sign ● Rigid plastic ● Break glass

Code	Size	Finish
H6800243	100x150mm	White/Green



Break Glass Bolt to Open

- Fire action sign ● Rigid plastic ● Break glass bolt to open

Code	Size	Finish
H6800244	100x150mm	White/Green



Turn to Open

- Fire action sign ● Rigid plastic ● Turn to open (Left)

Code	Size	Finish
H6800251	100x150mm	White/Green



Turn to Open

- Fire action sign ● Rigid plastic ● Turn to open (Right)

Code	Size	Finish
H6800252	100x150mm	White/Green



First Aid

- First aid point sign ● Rigid plastic

Code	Size	Finish
H6800261	100x150mm	White/Green



Push to Open

- Fire action sign ● Rigid plastic ● Push pad to open

Code	Size	Finish
H6800271	100x150mm	White/Green



Assembly Point

- Fire assembly point sign ● Rigid plastic
- Collective group with space to infill

Code	Size	Finish
H6800281	300x100mm	White/Green



Drinking Water

- Drinking water sign ● Rigid plastic

Code	Size	Finish
H6800291	300x100mm	White/Green



Emergency Stop

- Emergency stop sign ● Rigid plastic

Code	Size	Finish
H6800301	300x100mm	White/Green



Emergency Eye Wash

- Emergency eye wash station sign ● Rigid plastic

Code	Size	Finish
H6800311	300x100mm	White/Green
H6800312	300x200mm	White/Green



Push Bar to Open

- Fire action sign ● Rigid plastic ● Push bar to open

Code	Size	Finish
H6800331	300x150mm	White/Green



First Aid

- First aid sign ● Rigid plastic ● With space to infill

Code	Size	Finish
H6800341	300 x 100mm	White/Green



First Aid

- First aid sign ● Rigid plastic

Code	Size	Finish
H6800342	300x100mm	White/Green



First Aid Symbol

- First aid symbol ● Rigid plastic

Code	Size	Finish
H6800343	100x100mm	White/Green



Push Bar to Open

- Fire action sign ● Rigid plastic ● Push bar to open

Code	Size	Finish
H6800351	300x100mm	White/Green
H6800352	600x100mm	White/Green



Push to Open

- Fire action sign ● Rigid plastic
- To open arrow to right

Code	Size	Finish
H6800361	300x75mm	White/Green



Pull to Open

- Fire action sign ● Rigid plastic pull
- To open arrow to left

Code	Size	Finish
H6800362	300x75mm	White/Green



Fire Fighting Equipment Signs

Displaying the right signage is essential for improving the safety of a premises and will help to comply with the law. Fire safety is something all organisations need to address. We can source plenty of signs to keep staff and visitors to site well informed.



Fire Extinguisher Signs

- Fire extinguisher colour coded guide sign

Code	Size	Finish
H6800371	350x200mm	Multi
H6800372	600x370mm	Multi



Fire Extinguisher Sign Dry Powder

- Fire extinguisher sign • Rigid plastic • Dry powder

Code	Size	Finish
H6800374	202x82mm	Multi



Fire Extinguisher Sign Foam Spray

- Fire extinguisher sign • Rigid plastic • Foam spray

Code	Size	Finish
H6800375	202x82mm	Multi



Fire Extinguisher Sign Water

- Fire extinguisher sign • Rigid plastic • Water

Code	Size	Finish
H6800376	202x82mm	Multi



Fire Extinguisher Sign Carbon Dioxide

- Fire extinguisher sign • Rigid plastic • Carbon Dioxide

Code	Size	Finish
H6800377	202x82mm	Multi



Fire Blanket Sign

- Fire blanket sign • Rigid plastic

Code	Size	Finish
H6800378	202x82mm	Multi



Fire Hose Sign

- Fire hose reel sign • Rigid plastic

Code	Size	Finish
H6800379	202x82mm	Multi



According to the Fire Precautions (Workplace) Regulations 1997, non-automatic fire equipment should display safety signs in accordance with The Safety Signs and Signals Regulations 1996. These regulations require fire fighting equipment to be marked with a permanent sign board in red.

Fire Signs are designed to show location of fire-fighting equipment including extinguishers, hose reels, alarms and fire points.



Fire Hose Reel

- Fire hose reel instruction to operate sign ● Rigid plastic

Code	Size	Finish
H6800391	200x250mm	White/Red

Fire Point

- Fire point sign ● Rigid plastic ● With space to infill

Code	Size	Finish
H6800388	200x300mm	White/Red



Fire Host Reel

- Fire hose reel sign ● Rigid plastic

Code	Size	Finish
H6800384	300x100mm	White/Red



Fire Extinguisher

- Fire extinguisher keep clear sign ● Rigid plastic

Code	Size	Finish
H6800385	300x100mm	White/Red



Fire Point

- Fire point sign ● Rigid plastic

Code	Size	Finish
H6800386	300x100mm	White/Red



Fire Action

- Fire action sign with space to infill
- Rigid plastic

Code	Size
H6800661	200x300mm
H6800662	400x600mm



Fire Action

- Fire action (break glass) sign with space to infill ● Rigid plastic

Code	Size
H6800671	200x300mm
H6800572	400x600mm



Fire Action

- Fire action sign ● Rigid plastic

Code	Size
H6800681	200x300mm



Fire Action

- Fire action sign ● Rigid plastic

Code	Size
H6800691	200x300mm

Mandatory Signs

These fire door signs help to conform with Building Regulations 1991 which advise that all doors designed to be fire resistant should display an appropriate mandatory fire safety sign.

All signs comply to BS5499 Part 1/5, and are available in 1mm rigid plastic, self adhesive vinyl or metal screw disk.



Fire Door Keep Locked Shut

● Fire door keep locked shut sign ● Self adhesive vinyl

Code	Size	Finish
H6800441	80x80mm	White/Blue
H6800442	100x100mm	White/Blue
H6800443	150x150mm	White/Blue



Keep Locked Shut

● Keep locked shut sign ● Self adhesive vinyl

Code	Size	Finish
H6800451	100x100mm	White/Blue
H6800452	150x150mm	White/Blue



Fire Door Keep Shut

● Fire door keep shut sign ● Self adhesive vinyl

Code	Size	Finish
H6800431	80x80mm	White/Blue
H6800332	100x100mm	White/Blue
H6800333	150x150mm	White/Blue



Automatic Fire Door Keep Clear

● Automatic fire door keep clear sign ● Self adhesive vinyl

Code	Size	Finish
H6800461	80x80mm	White/Blue
H6800462	100x100mm	White/Blue



Fire Door Keep Closed

● Fire door keep closed sign ● Self adhesive vinyl

Code	Size	Finish
H6800471	100x100mm	White/Blue
H6800472	150x150mm	White/Blue



Automatically Close

● This door will automatically close when fire alarm operates
● Self adhesive vinyl

Code	Size	Finish
H6800481	100x100mm	White/Blue



Please Close This Door

● Please close this door sign ● Self adhesive vinyl

Code	Size	Finish
H6800511	100x100mm	White/Blue



Fire Escape Keep Clear

● Fire escape keep clear sign ● Self adhesive vinyl

Code	Size	Finish
H6800531	100x100mm	White/Blue
H6800532	150x150mm	White/Blue



Please Switch Off Lights

● Please switch off lights on leaving sign
● Self adhesive vinyl

Code	Size	Finish
H6800541	100x100mm	White/Blue
H6800542	150x150mm	White/Blue



Switch Off

● Switch off when not in use sign ● Self adhesive vinyl

Code	Size	Finish
H6800551	100x100mm	White/Blue
H6800552	150x150mm	White/Blue



Close These Doors

● Close these doors at night sign ● Self adhesive vinyl

Code	Size	Finish
H6800521	100x100mm	White/Blue
H6800522	150x150mm	White/Blue



Fire Door Keep Shut Sign Circular

● Dcsk for screw fix

Code	Dia	Finish
H6801071	76mm	Blue/Silver Aluminium
H6801072	76mm	Blue/Polished Brass
H6801073	76mm	Blue/Polished Stainless Steel
H6801074	76mm	Blue/Satin Stainless Steel



Fire Door Keep Locked Sign Circular

● Dcsk for screw fix

Code	Dia	Finish
H6801081	76mm	Blue/Silver Aluminium
H6801082	76mm	Blue/Polished Brass
H6801083	76mm	Blue/Polished Stainless Steel
H6801084	76mm	Blue/Satin Stainless Steel

Information Signs

These high quality information signs provide clear pictorial information to locations. They are pre drilled and countersunk for easy screwing to the substrate.



Male Pictogram Rectangular

• Dcsk for screw fix

Code	Size	Finish
H6801021	150x100mm	Silver Anodised Aluminium
H6801022	150x100mm	Polished Brass



Female Pictogram Rectangular

• Dcsk for screw fix

Code	Size	Finish
H6801031	150x100mm	Silver Anodised Aluminium
H6801032	150x100mm	Polished Brass



Disabled Person Pictogram Rectangular

• Dcsk for screw fix

Code	Size	Finish
H6801041	150x100mm	Silver Anodised Aluminium
H6801042	150x100mm	Polished Brass



Changing Places Pictogram Rectangular

• Dcsk for screw fix

Code	Size	Finish
H6801043	150x100mm	Silver Anodised Aluminium



Male Pictogram Circular

• Dcsk for screw fix

Code	Dia	Finish
H6801051	76mm	Silver Anodised Aluminium
H6801052	76mm	Polished Brass
H6801053	76mm	Polished Stainless Steel
H6801054	76mm	Satin Stainless Steel



Female Pictogram Circular

• Dcsk for screw fix

Code	Dia	Finish
H6801061	76mm	Silver Anodised Aluminium
H6801062	76mm	Polished Brass
H6801063	76mm	Polished Stainless Steel
H6801064	76mm	Satin Stainless Steel



Disabled Person Pictogram Circular

• Dcsk for screw fix

Code	Dia	Finish
H6801065	76mm	Silver Anodised Aluminium
H6801066	76mm	Polished Brass
H6801067	76mm	Polished Stainless Steel
H6801068	76mm	Satin Stainless Steel



Changing Places Pictogram Circular

• Dcsk for screw fix

Code	Dia	Finish
H6801069	76mm	Silver Anodised Aluminium



Unisex Pictogram Circular

• Dcsk for screw fix

Code	Dia	Finish
H6801095	76mm	Silver Anodised Aluminium
H6801096	76mm	Polished Brass
H6801097	76mm	Polished Stainless Steel



Baby Change Pictogram Circular

• Dcsk for screw fix

Code	Dia	Finish
H6801101	76mm	Silver Anodised Aluminium
H6801102	76mm	Polished Brass
H6801068	76mm	Satin Stainless Steel



Shower Area Pictogram Circular

• Dcsk for screw fix

Code	Dia	Finish
H6801091	76mm	Silver Anodised Aluminium
H6801092	76mm	Polished Brass
H6801093	76mm	Polished Stainless Steel
H6801094	76mm	Satin Stainless Steel



Staff Only Sign

● Rigid plastic

Code	Dia	Finish
H6801111	300x100mm	White/Black



Reception Sign

● Rigid plastic

Code	Dia	Finish
H6801112	300x100mm	White/Black



Office Sign

● Rigid plastic

Code	Dia	Finish
H6801113	300x100mm	White/Black



Gents Sign

● Rigid plastic

Code	Dia	Finish
H6801114	300x100mm	White/Black



Ladies Sign

● Rigid plastic

Code	Dia	Finish
H6801115	300x100mm	White/Black



Toilets Sign

● Rigid plastic

Code	Dia	Finish
H6801121	300x100mm	White/Black



Canteen Sign

● Rigid plastic

Code	Dia	Finish
H6801123	300x100mm	White/Black



Private Sign

● Rigid plastic

Code	Dia	Finish
H6801124	300x100mm	White/Black



Car Park Sign

● Rigid plastic

Code	Dia	Finish
H6801134	300x200mm	White/Black



No Parking Sign

● Rigid plastic

Code	Dia	Finish
H6801135	300x200mm	White/Black

Prohibition Signs

These blue and white signs should be used to indicate actions that must be carried out in order to comply with statutory requirements.

For example an area of a construction site where hard hats should be worn should have appropriate signs at the entry points.



Protective Equipment Must Be Worn In This Area Sign

● Rigid plastic

Code	Size	Finish
H6801353	200x300mm	White/Blue
H6801354	400x600mm	White/Blue



Protective Gloves Must Be Worn Sign

● Rigid plastic

Code	Size	Finish
H6801358	600x450mm	White/Red/Blue



Protective Clothing Must Be Worn Sign

● Rigid plastic

Code	Size	Finish
H6801371	300x100mm	White/Blue



Protective Footwear Must Be Worn Sign

● Rigid plastic

Code	Size	Finish
H6801374	600x200mm	White/Blue

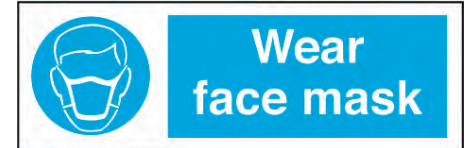

Wear Face Mask Sign

● Rigid plastic

Code	Size	Finish
H6801375	300x100mm	White/Blue



Eye Protection Must Be Worn Sign

● Rigid plastic

Code	Size	Finish
H6801381	300x100mm	White/Blue
H6801382	600x200mm	White/Blue

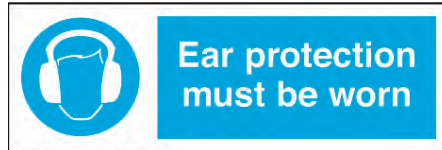

Ear Protection Must Be Worn Sign

● Rigid plastic

Code	Size	Finish
H6801383	300x100mm	White/Blue
H6801384	600x200mm	White/Blue



To Be Used By Trained And Authorised Personnel Only Sign

● Rigid plastic

Code	Size	Finish
H6801405	600x450mm	White/Blue



Hard Hat And High Visibility Vest To Be Worn In This Area Sign

● Rigid plastic

Code	Size	Finish
H6801394	600x450mm	White/Blue

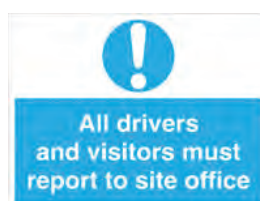

All Drivers And Visitors Must Report To Site Office Sign

● Rigid plastic

Code	Size	Finish
H6801393	600x450mm	White/Blue



Site Traffic 5 mph Speed Limit Sign

● Rigid plastic ● Non reflective

Code	Size	Finish
H6801503	300x300mm	White/Red/Black



Site Traffic 10 mph Speed Limit Sign

● Rigid plastic ● Non reflective

Code	Size	Finish
H6801504	300x300mm	White/Red/Black



Danger - Keep Out Sign

● Rigid plastic

Code	Size	Finish
H6801501	600x450mm	White/Blue/Yellow



Construction Site-Keep Out Sign

● Rigid plastic

Code	Size	Finish
H6801502	600x450mm	White/Blue/Yellow



Site Traffic 15 mph Speed Limit Sign

● Rigid plastic ● Non reflective

Code	Size	Finish
H6801505	300x300mm	White/Red/Black

Prohibition Signs

A range of prohibition signs used to instruct, inform, advise staff, visitors and members of the public in any action which is specifically prohibited. All prohibition signs comply with EN 7010 and The Health & Safety (Signs & Signals) Regulations 1996.



No Smoking Symbol

• Rigid plastic

Code	Size	Finish
H6801211	100x100mm	White/Red/Black
H6801212	200x200mm	White/Red/Black



No Persons Sign

• Rigid plastic

Code	Size	Finish
H6801222	200x200mm	White/Red/Black



No Smoking Sign

• Rigid plastic

Code	Size	Finish
H6801071	300x100mm	White/Red/Black
H6801143	600x200mm	White/Red/Black



No Smoking Beyond This Point Sign

• Rigid plastic

Code	Size	Finish
H6801161	300x100mm	White/Red/Black



Strictly No Admittance Sign

• Rigid plastic

Code	Size	Finish
H6801171	300x100mm	White/Red/Black
H6801172	600x200mm	White/Red/Black

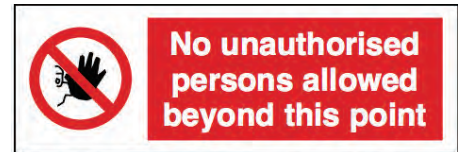

No Unauthorised Persons Allowed Beyond This Point Sign

• Rigid plastic

Code	Size	Finish
H6801181	300x100mm	White/Red/Black



No Smoking Or Naked Lights Sign

• Rigid plastic

Code	Size	Finish
H6801232	400x600mm	White/Red/Black



Strictly No Admittance Sign

• Rigid plastic

Code	Size	Finish
H6801241	400x600mm	White/Red/Black

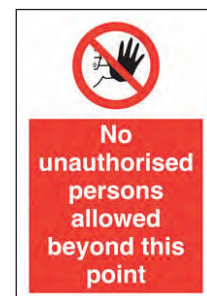

No Unauthorised Persons Allowed Beyond This Point Sign

• Rigid plastic

Code	Size	Finish
H6801252	400x600mm	White/Red/Black



No Admittance Authorised Personnel Only Sign

• Rigid plastic

Code	Size	Finish
H6801272	400x600mm	White/Red/Black



No Parking Sign

• Rigid plastic

Code	Size	Finish
H6801282	400x600mm	White/Red/Black



No Exit Sign

• Rigid plastic

Code	Size	Finish
H6801291	200x300mm	White/Red/Black



No Entry Sign

• Rigid plastic

Code	Size	Finish
H6801272	400x600mm	White/Red/Black



No Tipping Or Dumping Sign

• Rigid plastic

Code	Size	Finish
H6801333	400x600mm	White/Red/Black



No Exit Sign

• Rigid plastic

Code	Size	Finish
H6801343	600x450mm	White/Red/Black



Hazard Signs

Hazard signs are intended to instruct, advise and warn staff, visitors and members of the public about potential dangers. All hazard signs comply to EN 7010 specifications.



Warning - CCTV In Operation Sign

• Rigid plastic

Code	Size	Finish
H6801511	400x300mm	White/Yellow/Black



Warning - These Premises Are Under CCTV Surveillance Sign

• Rigid plastic

Code	Size	Finish
H6801512	400x300mm	White/Yellow/Black



These Premises Are Under CCTV Surveillance Sign With Space To Infill

• Rigid plastic

Code	Size	Finish
H6801513	400x300mm	White/Yellow/Black



This Organisation Operates 24hr CCTV Surveillance Sign With Space To Infill

• Rigid plastic

Code	Size	Finish
H6801514	400x300mm	White/Yellow/Black



Mind The Step Sign

• Rigid plastic

Code	Size	Finish
H6801521	200x300mm	White/Yellow/Black



Mind Your Head Sign

• Rigid plastic

Code	Size	Finish
H6801523	400x300mm	White/Yellow/Black



Danger - Fragile Roof Sign

• Rigid plastic

Code	Size	Finish
H6801525	200x300mm	White/Yellow/Black



Caution - Fork Lift Trucks Operating Sign

• Rigid plastic

Code	Size	Finish
H6801527	200x300mm	White/Yellow/Black
H6801528	400x600mm	White/Yellow/Black



Danger - Men At Work Sign

• Rigid plastic

Code	Size	Finish
H6801530	400x600mm	White/Yellow/Black



Site Entrance Sign

• Rigid plastic

Code	Size	Finish
H6801541	600x450mm	White/Yellow/Black



Construction Site Keep Out Sign

• Rigid plastic

Code	Size	Finish
H6801542	600x450mm	White/Yellow/Black



Danger - Overhead Live Wires Sign

• Rigid plastic

Code	Size	Finish
H6801543	600x450mm	White/Yellow/Black



Danger - Demolition In Progress Sign

• Rigid plastic

Code	Size	Finish
H6801561	600x450mm	White/Yellow/Black



Site Safety Sign

• Rigid plastic

Code	Size	Finish
H6801581	800x600mm	Multi



Site Safety Sign

• Rigid plastic

Code	Size	Finish
H6801582	800x600mm	Multi



Made to order signs

If you have a bespoke requirement for signage, Nicholls & Clarke can help create your desired communication, sign fixings in a choice of colours, materials and sizes.

Tactile & Braille Signs

Braille is a way for people with visual impairment to read through a series of raised dots that represent text. Our braille signs are manufactured to conform with the DDA Act 1995 and more recently, the Equality Act 2010 which suggests that businesses and organisations must make reasonable adjustments such as providing large, well defined braille and tactile signs for the visually impaired.



Male Tactile & Braille Pictogram

- Dcsk for screw fix

Code	Dia	Finish
H6801606	75mm	Satin Stainless Steel
H6801667	75mm	Silver Aluminium

- Self Adhesive

H6801607	75mm	Blue/White
----------	------	------------



Female Tactile & Braille Pictogram

- Dcsk for screw fix

Code	Dia	Finish
H6801608	75mm	Satin Stainless Steel
H6801668	75mm	Silver Aluminium

- Self Adhesive

H6801609	75mm	Blue/White
----------	------	------------



Unisex Tactile & Braille Pictogram

- Dcsk for screw fix

Code	Dia	Finish
H6801604	75mm	Satin Stainless Steel
H6801605	75mm	Blue/White



WC Tactile & Braille Pictogram

- Dcsk for screw fix

Code	Dia	Finish
H6801600	75mm	Satin Stainless Steel
H6801601	75mm	Blue/White



Baby Change Tactile & Braille Pictogram

- Dcsk for screw fix

Code	Dia	Finish
H6801602	75mm	Satin Stainless Steel
H6801669	75mm	Silver Aluminium

- Self adhesive

H6801603	75mm	Blue/White
----------	------	------------



Disabled Person Tactile & Braille Pictogram

- Dcsk for screw fix

Code	Dia	Finish
H6801610	75mm	Satin Stainless Steel
H6801666	75mm	Silver Aluminium

- Self adhesive

H6801611	75mm	Blue/White
----------	------	------------



First Aid Symbol Tactile & Braille Pictogram

- Dcsk for screw fix

Code	Dia	Finish
H6801612	75mm	Satin Stainless Steel

- Self adhesive

H6801611	75mm	Blue/Stainless Steel
----------	------	----------------------



Toilets Tactile & Braille Pictogram

- Dcsk for screw fix

Code	Dia	Finish
H6801616	75mm	Satin Stainless Steel

- Self adhesive

H6801617	75mm	Blue/Whitel
----------	------	-------------



Shower Area Tactile & Braille Pictogram

- Dcsk for screw fix

Code	Dia	Finish
H6801614	75mm	Satin Stainless Steel

- Self adhesive

H6801615	75mm	Blue/White
----------	------	------------



Male Tactile & Braille Pictogram

- Dcsk for screw fix

Code	Size	Finish
H6801672	150x100mm	Silver Anodised Alluminum



Female Tactile & Braille Pictogram

- Dcsk for screw fix

Code	Size	Finish
H6801671	150x100mm	Silver Anodised Alluminum



Disabled Person Tactile & Braille

- Dcsk for screw fix

Code	Size	Finish
H6801673	150x100mm	Silver Anodised Alluminum



Changing Places Tactile & Braille

- Dcsk for screw fix

Code	Size	Finish
H6801670	150x100mm	Silver Anodised Alluminum



WC Tactile & Braille Pictogram

• Dcsk for screw fix

Code	Size	Finish
H6801636	150x150mm	Satin Stainless Steel

• Self Adhesive

H6801637	150x150mm	Blue/White
----------	-----------	------------



Baby Change Tactile & Braille Pictogram

• Dcsk for screw fix

Code	Size	Finish
H6801632	150x150mm	Satin Stainless Steel

• Self Adhesive

H6801653	150x150mm	Blue/White
----------	-----------	------------



Unisex Tactile & Braille Pictogram

• Dcsk for screw fix

Code	Size	Finish
H6801624	150x150mm	Satin Stainless Steel

• Self Adhesive

H6801625	150x150mm	Blue/White
----------	-----------	------------



Male Tactile & Braille Pictogram

• Dcsk for screw fix

Code	Size	Finish
H6801618	150x150mm	Satin Stainless Steel

• Self Adhesive

H6801619	150x150mm	Blue/White
----------	-----------	------------



Female Tactile & Braille Pictogram

• Dcsk for screw fix

Code	Size	Finish
H6801620	150x150mm	Satin Stainless Steel

• Self Adhesive

H6801621	150x150mm	Blue/White
----------	-----------	------------



Disabled Person Tactile & Braille Pictogram

• Dcsk for screw fix

Code	Size	Finish
H6801622	150x150mm	Satin Stainless Steel

• Self Adhesive

H6801623	150x150mm	Blue/White
----------	-----------	------------



Family WC Tactile & Braille Pictogram

• Dcsk For Screw Fix

Code	Size	Finish
H6801628	150x150mm	Satin Stainless Steel

• Self Adhesive

H6801629	150x150mm	Blue/White
----------	-----------	------------



Boy WC Tactile & Braille Pictogram

• Dcsk For Screw Fix

Code	Size	Finish
H6801633	150x150mm	Satin Stainless Steel

• Self Adhesive

H6801639	150x150mm	Blue/White
----------	-----------	------------



Girl WC Tactile & Braille Pictogram

• Dcsk For Screw Fix

Code	Size	Finish
H6801640	150x150mm	Satin Stainless Steel

• Self Adhesive

H6801641	150x150mm	Blue/White
----------	-----------	------------



Toilets Tactile & Braille Pictogram

• Dcsk For Screw Fix

Code	Size	Finish
H6801626	150x150mm	Satin Stainless Steel

• Self Adhesive

H6801627	150x150mm	Blue/White
----------	-----------	------------



Shower Area Tactile & Braille Pictogram

• Dcsk For Screw Fix

Code	Size	Finish
H6801630	150x150mm	Satin Stainless Steel

• Self Adhesive

H6801631	150x150mm	Blue/White
----------	-----------	------------



Telephone Tactile & Braille Pictogram

• Dcsk For Screw Fix

Code	Size	Finish
H6801634	150x150mm	Satin Stainless Steel

• Self Adhesive

H6801635	150x150mm	Blue/White
----------	-----------	------------



Push Plate Tactile & Braille

- Dcsk for screw fix

Code	Size	Finish
H6801642	400x100mm	Satin Stainless Steel

- Self adhesive

H6801643	400x100mm	White
----------	-----------	-------



Pull Plate Tactile & Braille

- Dcsk for screw fix

Code	Size	Finish
H6801644	400x100mm	Satin Stainless Steel

- Self adhesive

H6801645	400x100mm	White
----------	-----------	-------



Staff Only Tactile & Braille

- Dcsk for screw fix

Code	Size	Finish
H6801646	225x80mm	Satin Stainless Steel

- Self adhesive

H6801647	225x80mm	Blue/White
----------	----------	------------



Push Tactile & Braille

- Dcsk for screw fix

Code	Size	Finish
H6801648	125x80mm	Satin Stainless Steel

- Self adhesive

H6801649	125x80mm	Blue/White
----------	----------	------------



Pull Tactile & Braille

- Dcsk for screw fix

Code	Size	Finish
H6801652	125x80mm	Satin Stainless Steel

- Self adhesive

H6801653	125x80mm	Blue/White
----------	----------	------------



Private Tactile & Braille

- Dcsk for screw fix

Code	Size	Finish
H6801650	160x80mm	Satin Stainless Steel

- Self adhesive

H6801651	160x80mm	Blue/White
----------	----------	------------



Kitchen Tactile & Braille

- Dcsk for screw fix

Code	Size	Finish
H6801648	175x80mm	Satin Stainless Steel

- Self adhesive

H6801659	175x80mm	Blue/White
----------	----------	------------



Library Tactile & Braille

- Dcsk for screw fix

Code	Size	Finish
H6801656	160x80mm	Satin Stainless Steel

- Self adhesive

H6801657	160x80mm	Blue/White
----------	----------	------------



Enquiries Tactile & Braille

- Dcsk for screw fix

Code	Size	Finish
H6801654	225x80mm	Satin Stainless Steel

- Self adhesive

H6801649	225x80mm	Blue/White
----------	----------	------------



Store Tactile & Braille

- Dcsk for screw fix

Code	Size	Finish
H6801664	140x80mm	Satin Stainless Steel

- Self adhesive

H6801665	140x80mm	Blue/White
----------	----------	------------



Toilets Tactile & Braille

- Dcsk for screw fix

Code	Size	Finish
H6801660	160x80mm	Satin Stainless Steel

- Self adhesive

H6801661	160x80mm	Blue/White
----------	----------	------------



Office Tactile & Braille

- Dcsk for screw fix

Code	Size	Finish
H6801662	225x80mm	Satin Stainless Steel

- Self adhesive

H6801663	225x80mm	Blue/White
----------	----------	------------

Sliding Door Gear

N&C are specialists in Sliding Gear Systems for sliding doors and folding doors. Our products are highly versatile and can be used in a variety of different applications from wardrobes, glass panels, timber doors, warehouse doors, shop fronts and gates.

Our sliding door gear can also be used in many non-door applications such as fall arrest systems or for sliding machinery, industrial curtains, sports equipment, projector screens and blackboards.

From the table below, please select the appropriate sliding gear:

Name	Door Types					Fixing		Max. Door Weight
	Sliding			Folding		Face	Soffit	
	Wardrobe & Cupboard (Wood)	Cupboard	Room Divider (Wood)	Wardrobe & Cupboard (Wood)	Room Divider (Wood)			
Slipper	●						(C) (D) OR (E)	9kg
Bifold				●			(F)	14kg
Cello	●							25kg
Loretto	●							25kg
Zenith		●						25kg
Senator						(A) OR (B)	(C) (D) OR (E)	30kg
Double Top	●						(C) (D) OR (E)	45kg
Phantom			●			(A) OR (B)	(C) (D) OR (E)	45kg
Single Top	●					(A) OR (B)	(C) (D) OR (E)	45kg
Pocket Door			●				(D) OR (E)	60kg
Marathon 55			●			(A) OR (B)	(C) (D) OR (E)	55kg
Marathon 90			●			(A) OR (B)	(C) (D) OR (E)	90kg
Husky Folding 25				●	●		(F)	25kg
Husky Folding 40				●	●		(F)	40kg
Husky Folding 50	●		●			(A) OR (B)	(C) (D) OR (E)	50kg
Husky Folding 100	●		●			(A) OR (B)	(C) (D) OR (E)	100kg

There are two common fixing methods:
Face fixed and Soffit fixed

Face fixed systems (A&B) are for sliding doors and the track is attached to the side of the wall facing the room.

Soffit fixed systems are for either sliding or folding doors and the track is attached to the lintel. Track can be fitted within the opening width (C - sliding doors or F - folding doors) or extend into the wall cavity (D & E - sliding only).

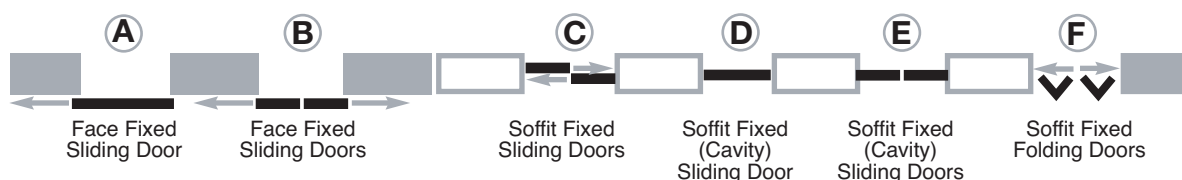



All products with in this section are suitable for commercial, domestic and education environments

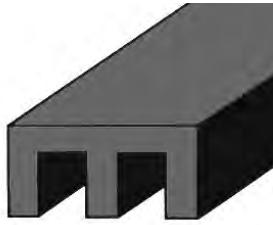

Chasmoor Channel No 76

- Sliding doors ● Double channel
- 6mm thick glass ● Top channel 2000mm

Code	Size	Finish
H0871501	20x13mm	Black plastic

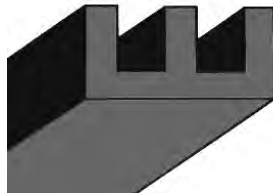

Chasmoor Channel No 75

- Sliding doors ● Double channel
- 6mm thick glass ● Bottom channel 2000mm

Code	Size	Finish
H0871511	20x10mm	Black plastic



Chasmoor Channel No 74

- Sliding doors ● Single channel
- 6mm thick glass ● Top channel 2000mm

Code	Size	Finish
H0872001	13x10mm	Black plastic

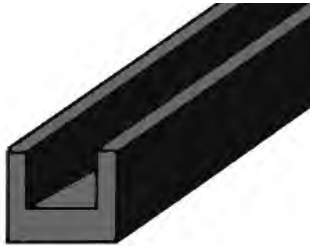

Chasmoor Channel No 73

- Sliding doors ● Single channel
- 6mm thick glass ● Bottom channel 2000mm

Code	Size	Finish
H0872011	10x10mm	Black plastic

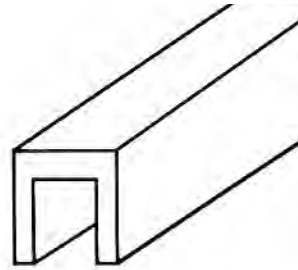

Chasmoor Channel No 35

- Sliding doors ● Double channel
- Rigid PVC inserts ● Top channel 2000mm

Code	Size	Finish
H0872501	18x11mm	Silver Aluminium

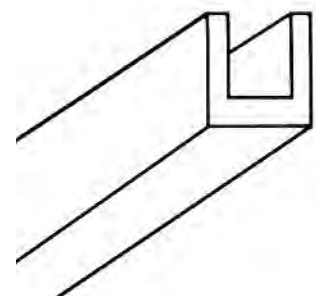

Chasmoor Channel No 34

- Sliding doors ● Double channel
- Rigid PVC inserts ● Bottom channel 2000mm

Code	Size	Finish
H0872511	18x11mm	Silver Aluminium



Nylonslide BO 634024P

- Sliding doors ● Double roller channel
- 6mm thick glass ● Top/side channel 2000mm

Code	Size	Finish
H0873001	21x18mm	Polished aluminium

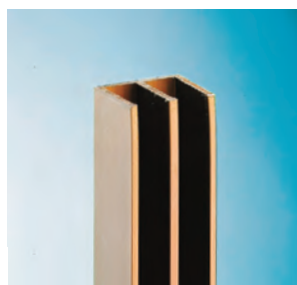

Nylonslide BO 634020P

- Sliding doors ● Double roller channel
- 6mm thick glass ● Bottom channel 2000mm

Code	Size	Finish
H0873011	21x18mm	Polished aluminium



Nylonslide BO 634021TP

- Sliding doors ● Single roller channel
- 6mm thick glass ● Top/side channel 2000mm

Code	Size	Finish
H0873501	13x18mm	Polished aluminium

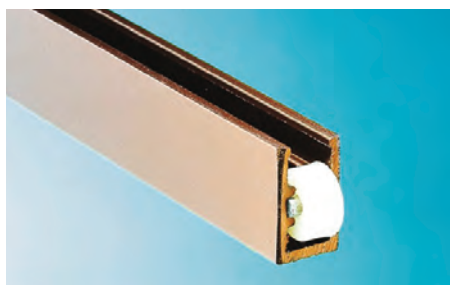

Nylonslide BO 634027P

- Sliding doors ● Single roller channel
- 6mm thick glass ● Bottom channel 2000mm

Code	Size	Finish
H0873511	13x18mm	Polished aluminium



Ratchet Lock

- For pair of frameless glass doors
- 2 Keys

Code	Size	Finish
H0027501	114mm	Polished chrome



Cylinder Lock "Plunge" Sliding Door

- For Light wood or Glass

Code	Size	Finish
H0026501	Light timber 19mm	Polished chrome
H0267001	Glass doors 25mm	Polished chrome

Slipper

An ideal system for fitted furniture where no bottom track is required; such as serving hatches, cupboards or anything with lightweight timber or chipboard sliding doors.

Quiet nylon rollers on aluminium track doors easily removed for cleaning & decorating

- Max Door Weight 9Kg
- Max Door Width 900mm
- Max Door Thickness 16mm

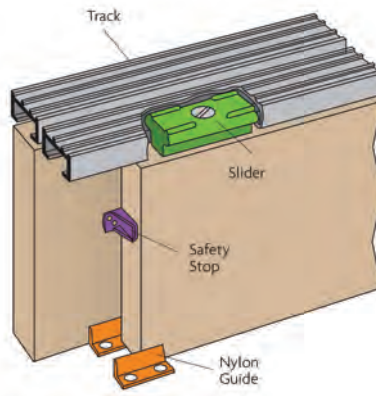

Slipper 2 Door Kit

- Aluminium

Code Size

H9994025 SS4 Kit 1200mm

H9994026 SS5 Kit 1500mm

H9994027 SS6 Kit 1800mm

Zenith

A versatile system for showcases, bookcases, display panels, hatches interior windows or anything else requiring a lightweight sliding glass door. Aluminium gear with brush pile strips on guide rail. Silent & easy glide motion

- Max Door Weight 25Kg
- Max Door Width 916mm
- Max Door Thickness 6mm

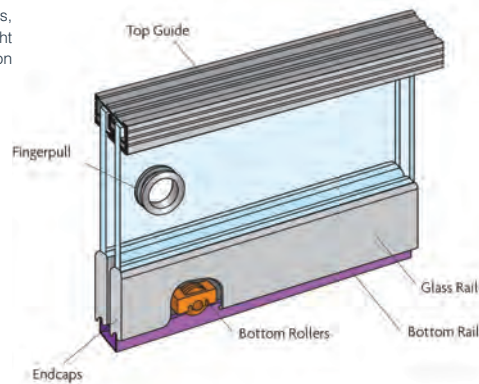

Zenith 2 Door Kit

- Aluminium

Code Size

H0880501 Z12 Kit 1200mm

H0880511 Z15 Kit 1500mm

H0880521 Z18 Kit 1800mm

Zenith Cylinder Lock

- Polished chrome

Code

H0880551 Left hand

H0880561 Right hand

Zenith Finger Pull

- Polished chrome

Code Size

H0880571 22mm Dia

Cello

A perfect system for timber, timber framed or composite wardrobe sliding doors bottom rollers operate quietly on aluminium rails easy to install with no routing of doors required

- Max Door Weight 25Kg
- Max Door Width 920mm
- Max Door Thickness 36mm

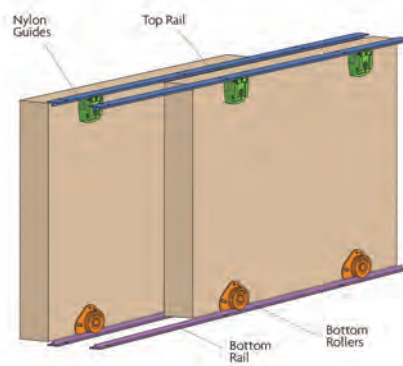

Cello Door Kit

- Aluminium

Code Size

H9994021 C15 2 door kit 1500mm

H0892021 C18 3 door kit 2400mm

Loretto

Especially designed to work with timber framed, glazed & flush doors high quality finish for wardrobes, cupboards, bookcases & other cabinet work nylon rollers operate quietly on aluminium rails multiple tracks can be fitted

- Max Door Weight 23Kg
- Max Door Width 900mm
- Max Door Thickness 36mm

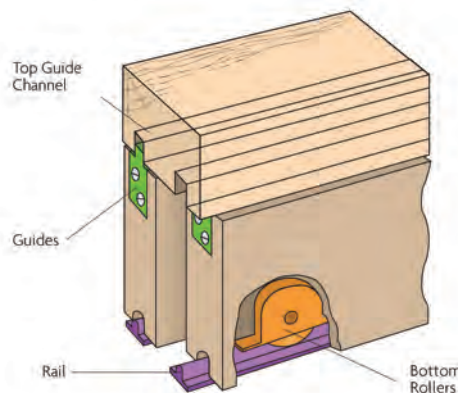

Loretto 2 Door Kit

- Aluminium

Code Size

H9994023 D4 Kit 1200mm

H9994024 D5 Kit 1500mm

H0880021 D6 Kit 1800mm

Senator

An Elegant, Premium Quality Sliding Mechanism For Heavier Entrance & Room Dividing Doors
 Suitable For Timber, Timber Framed & Composite Doors
 Standard Kit For Single Leaf Door
 Easy Fix Floor Guide

- Max Door Weight 30Kg
- Max Door Width 900mm
- Max Door Thickness 35mm

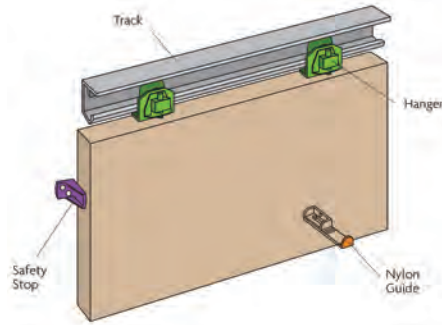

Senator SEN Kit

- Aluminium

Code	Size
H9994017	SEN Kit 1500mm

Phantom

An exceptionally quiet, frictionless & easy to operate sliding mechanism suitable for any room in a residential, hospital or hotel environment suitable for timber, timber framed & composite doors.
 Standard Kit For Single Leaf Door.
 Optional kits for conversion to simultaneous action or self closing doors.

- Max Door Weight 45Kg
- Max Door Width 915mm
- Max Door Thickness 50mm

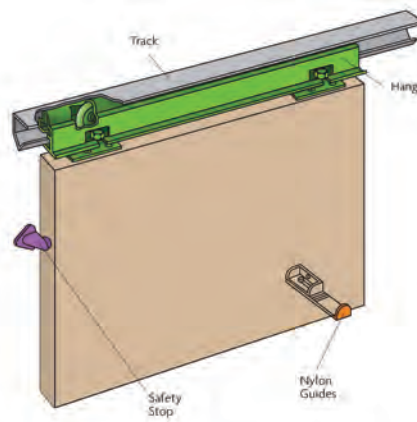

Phantom P9 Kit

- Aluminium

Code	Size
H9994016	P9 Kit 1500mm

Double Top

The perfect choice for heavy duty sliding door applications suitable for larger wardrobes & cupboards in hotels, schools, hospitals & offices
 Double track for bi-passing doors
 Nylon hangers work silently on aluminium track

- Max Door Weight 45Kg
- Max Door Width 900mm
- Max Door Thickness 40mm

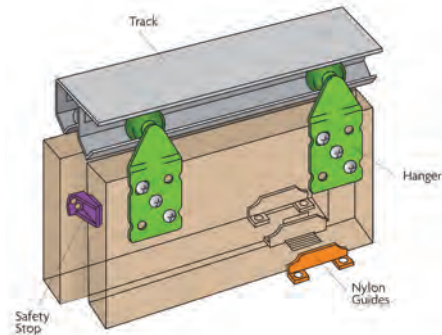

Double Top Kit Door Kit

- Aluminium ● Double Doors

Code	Size
H9994000	Kit W12 1200mm
H9994001	Kit W15 1500mm
H9994002	Kit W18 1800mm
H9994003	Kit W24 2400mm
H0881541	Kit W01 Adds Additional Door

Single Top

Graceful solution for residential wardrobe doors suitable for timber framed or composite doors
 Nylon Rollers operate quietly & smoothly on aluminium rails

- Max Door Weight 45Kg
- Max Door Width 900mm
- Max Door Thickness 40mm

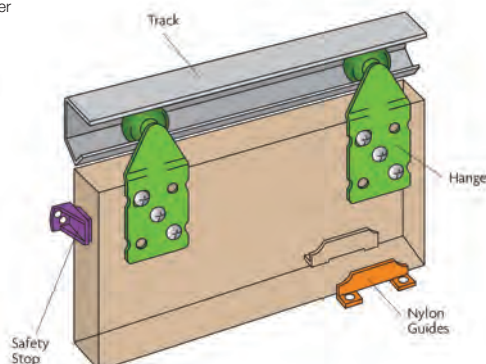

Single Door Door Kit

- Aluminium ● Single Door

Code	Size
H9994028	ST12 Kit 1200mm
H9994029	ST15 Kit 1500mm
H9994030	ST18 Kit 1800mm

Marathon Sliding 55

A unique simultaneous opening action, easily adjusted door heights & a fire door kit option available
Suitable for both light & heavy duty commercial sliding doors & partitions steel track

- Max Door Weight 55Kg
- Max Door Width 1200mm
- Max Door Thickness 50mm

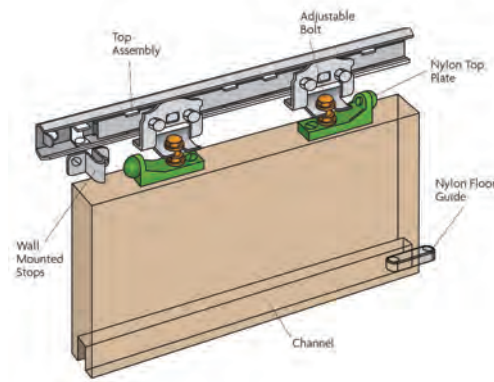

Marathon 55 - 1 Door Kit

- Steel

Code	Size
H9994004	J2 Kit 1219mm
H9994005	J3 Kit 1473mm
H9994006	J4 Kit 1702mm
H9994007	J5 Kit 1981mm
H9994008	J6 Kit 2438mm

Marathon Sliding 90

A unique simultaneous opening action, easily adjusted door heights & a fire door kit option available
Suitable for both light & heavy duty commercial sliding doors & partitions

- Max Door Weight 90Kg
- Max Door Width 1200mm
- Max Door Thickness 50mm
- Steel Track

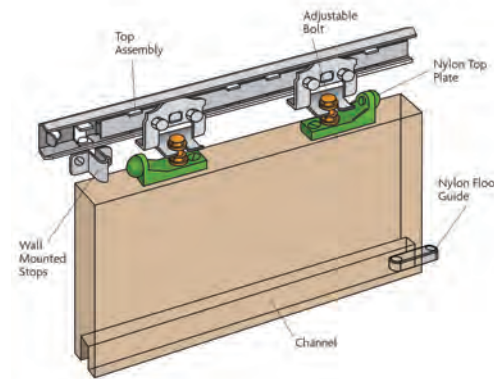

Marathon 90 - 1 Door Kit

- Steel

Code	Size
H0884001	S3 Kit 1473mm
H0884011	S4 Kit 1702mm
H0884021	S5 Kit 1981mm
H0884031	S6 Kit 2438mm

Husky Sliding 100

A versatile & silent system for creating wardrobe doors & room dividers. Suitable for timber, timber framed or metal doors steel track

- Max Door Weight 100Kg
- Max Door Width 1250mm
- Max Door Thickness 50mm

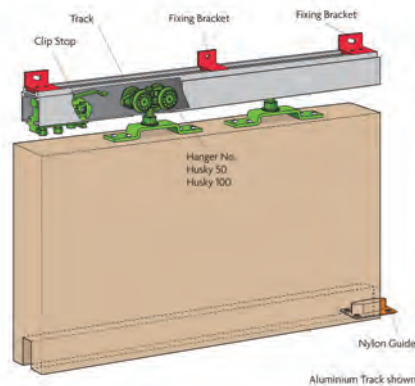

Husky 100 - 1 Door Kit

- Steel

Code	Size
H9994009	18 Kit 1800mm
H9994010	20 Kit 2000mm
H9994011	24 Kit 2400mm

Pocket

A set that provides the structure & sliding door gear for residential doors to slide into a wall cavity. Ideally suited to applications where space is at a premium such as toilets, bathrooms & kitchens. Pre assembled aluminium track & header assembly. Galvanised steel studs, spacers & brackets softwood header assembly

- Max Door Weight 60Kg
- Max Door Width 930mm
- Max Door Thickness 44mm

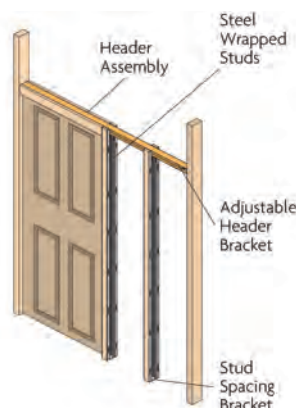

Pocket Door PDK10 - 1 Door Kit

- Steel/Aluminium

Code	Size
H0884161	Kit PDK10

(Satin Flush Pull & Finger Pull Included)

When assembled using 12.5mm Wallboards O/A wall thickness is 115mm

Bi-Fold

A stable & smooth opening folding system for wardrobe doors.
 Designed for timber, timber framed or composite doors.
 Aluminium top track with fittings & spring loaded guides
 Low maintenance system & suitable for jambless openings

- Max Door Weight 14Kg
- Max Door Width 530mm
- Max Door Thickness 35mm

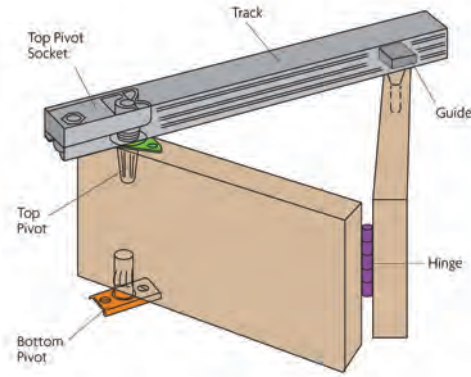

Bi-Fold Door Kit

● Aluminium

Code Size

H9994018 Kit B10/2 2 Doors 1067mm

H9994019 Kit B15/4 4 Doors (2+2) 1524mm

H9994020 Kit B20/4 4 Doors (2+2) 2134mm

Husky Folding 25

A flexible solution for both light & medium weight folding partitions.
 Concealed fixings & robust floor gear allow partitions to be neatly stacked at one side

- Max Door Weight 25Kg*
- Max Door Width 600mm
- Max Door Thickness 44mm

* Husky folding 25 can support doors of up to 25kg without a floor channel

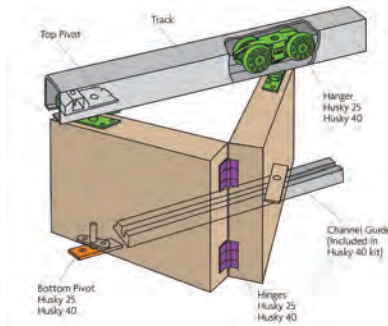

Husky Folding 25 Door Kit

● Steel

Code Size

H9994012 Kit H25/12 - 2 Doors 1200mm

H9994013 Kit H25/24 - 4 Doors 2400mm

Husky Folding 40

A flexible solution for both light & medium weight folding partitions.
 Concealed fixings & robust floor gear allow partitions to be neatly stacked at one side

- Max Door Weight 40Kg*
- Max Door Width 750mm
- Max Door Thickness 44mm

*Husky Folding 40 Can Support Doors Of Up To 40kg without a floor channel

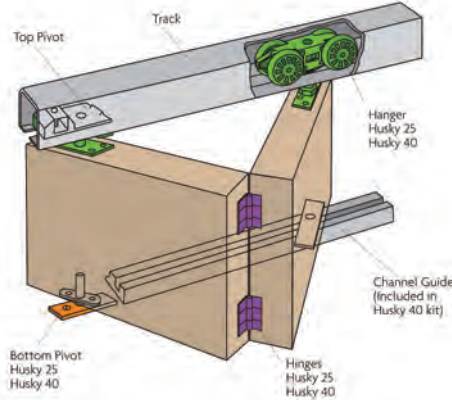

Husky Folding 40 Door Kit

● Steel

Code Size

H9994014 Kit H40/15 - 2 Doors 1500mm

H9994015 Kit H40/30 - 4 Doors 3000mm





Henderson 290

Straight sliding system for both timber & steel doors. Widely used in lighter commercial & industrial applications to cover any width of opening. Any number of doors can be used on single or multiple lines of track to accommodate different building designs, doors can slide to one or both sides

- Max Door Weight
 - 150Kg Nylon Wheel Hanger
 - 200Kg Steel Wheel Hanger
 - Max Door Height 3000mm
 - Max Door Thickness 48mm
- (For ease of operation it is recommended that door width should not exceed 75% of door height)

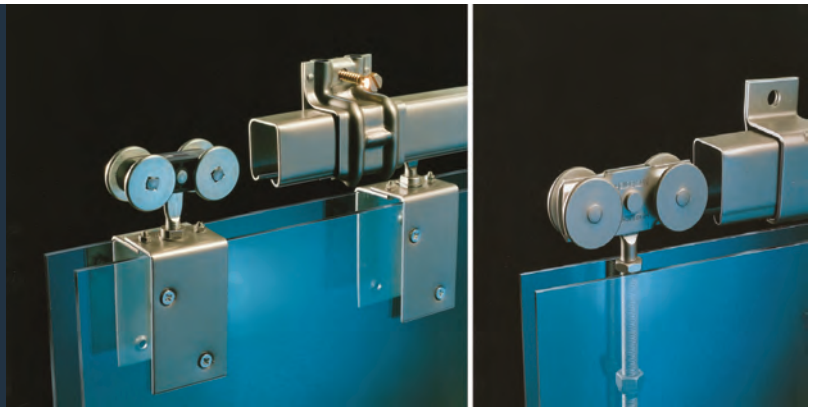

Henderson 290 Track

- Steel

Code	Size
H0885001	Top Track 1800mm
H0885021	Top Track 3000mm

Henderson 290 Open Bracket

- Aluminium

Code	Size
H0885501	1A/290 Face Fix Open Bracket

Henderson 290 End Clip

- Aluminium

Code	Size
H088511	1A/290EC to Close Open Bracket

Henderson 290 Joint Bracket

- Aluminium

Code	Size
H088531	1AX/290 Face Fix

Henderson 290 Wheel Hanger S/P

- Nylon

Code	Size
H0886001	53K/N 4 Nylon Wheel Door Hanger Side Plate Fixing

Henderson 290 Wheel Hanger S/P

- Steel

Code	Size
H0886011	54K/S 4 Steel Wheel Hanger Side Plate Fixing

Henderson 290 Wheel Hanger A/P

- Nylon

Code	Size
H0886021	52K/N 4 Nylon Wheel Door Hanger Angle Plate Fixing

Henderson 290 Wheel Hanger T/P

- Steel

Code	Size
H0886031	57K/N 4 Steel Wheel Hanger Top Plate Fixing

Henderson 290 Bottom Guide Channel

- Steel

Code	Size
H0886501	1800mm
H0886511	2500mm
H0886521	3000mm

Henderson 290 Bottom Guide

- Steel

Code	Size
H0887001	105R/89 Face Fix



414 Flush Pull Handle

Code	Size	Finish
H0890001		Grey



863 Bow Handle - Face Fix

Code	Size	Finish
H0890501		Grey



Wall Mounted Door Stop

Code		Finish
H0891001	Double Door Stop	Steel
H0891011	Single Door Stop	Steel



Straight sliding system for both timber & steel doors. Widely used in commercial, industrial & agricultural applications to cover any width of opening. Any number of doors can be used on single or multiple lines of track to accommodate different building designs, doors can slide to one or both sides

- Max Door Weight
400Kg (Nylon Wheel Hanger)
300Kg (Steel Wheel Hanger)
- Max Door Height 3600mm
- Max Door Thickness 57mm

(For ease of operation it is recommended that door width should not exceed 75% of door height)

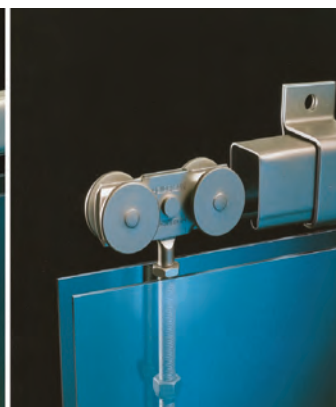
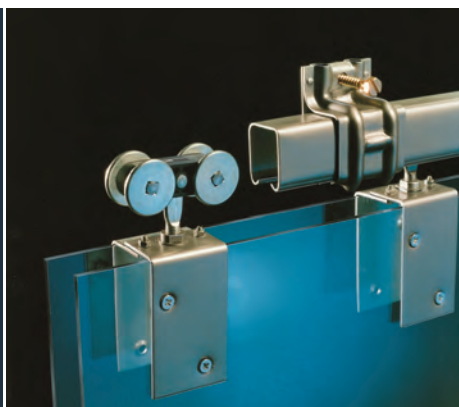

Henderson 301 Top Track

- Steel

Code	Size
H0887501	Top Track 1800mm
H0887511	Top Track 2500mm
H0887521	Top Track 3000mm

Henderson 301 Open Bracket

- Aluminium

Code	Size
H0888001	1A/301 Face Fix Open Bracket

Henderson 301 End Clip

- Aluminium

Code	Size
H0888011	1A/301EC to Close Open Bracket



Henderson 301 Joint Bracket

- Aluminium

Code	Size
H0888021	1AX/301 Face Fix

Henderson 301 Wheel Hanger S/P

- Nylon

Code	Size
H0888501	53A/S 4 Steel Wheel Door Hanger Side Plate Fixing

Henderson 301 Wheel Hanger A/P

- Nylon

Code	Size
H0888531	52A/N 4 Nylon Wheel Door Hanger Angle Plate Fixing



Henderson 301 Bottom Guide Channel

- Steel

Code	Size
H0889001	1800mm
H0889011	2500mm
H0889021	3000mm

Henderson 290 Bottom Guide

- Steel

Code	Size
H0889501	102/97 Face Fix Self Cleaning
H0889511	106R/97 Bottom Fix



414 Flush Pull Handle

Code	Size	Finish
H0890001		Grey

863 Bow Handle - Face Fix

Code	Size	Finish
H0890501		Grey

Wall Mounted Door Stop

Code	Size	Finish
H0891001	Double Door Stop	Steel
H0891011	Single Door Stop	Steel

Cabinet, Cubicle Fittings & Shelving

Whether proudly displaying show pieces, hiding files in offices or storing goods in kitchens, cabinets work hard to improve spaces, N&C sources a huge variety of cabinet components, from cabinet hinges and stays, cabinet locks and cabinet fittings to cabinet legs and feet.

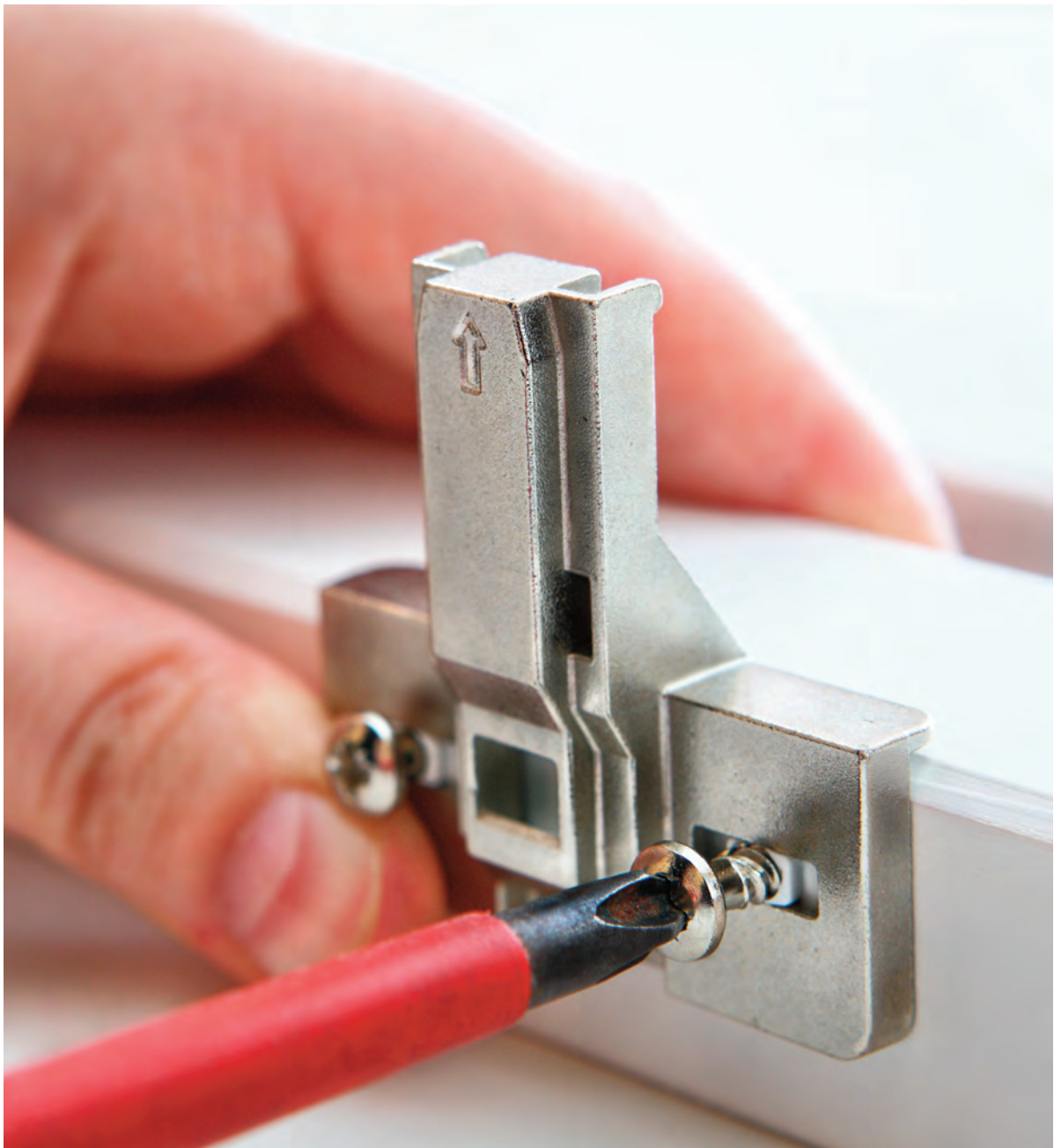

All products within this section are suitable for commercial, domestic and education environments



N&C Light Duty Cupboard Locks

- Light duty straight cupboard lock • 1 key
- Double handed for left or right hand use
- 2 way keyhole enabling use as a drawer lock
- 2 lever mechanism • No differs

Code	Case	Finish
H0020001	51x26mm	Brass
H0020002	64x32mm	Brass



N&C Heavy Duty Cupboard Locks

- Heavy duty straight cupboard lock • 2 keys
- Double handed for left or right hand use
- 2 way keyhole enabling use as a drawer lock
- 4 lever mechanism • 12 differs

Code	Case	Finish
H0020003	51x26mm	Brass
H0020004	64x32mm	Brass



N&C Heavy Duty Cupboard Locks

- Heavy duty straight cupboard lock • 2 keys
- 4 lever mechanism • 12 differs

Code	Case	Hand	Finish
H0020501	64x35mm	Right	Brass
H0020502	64x35mm	Left	Brass



N&C Heavy Duty Till/Drawer Lock

- 2 way keyhole allows left hand cupboard use
- 2 keys • 4 lever mechanism • 12 differs

Code	Case	Hand	Finish
H0021002	64x44mm	Right	Brass
H0021501	64x44mm	Left	Brass



N&C Heavy Duty Box Lock

- Brass Link Plate • 2 Keys • 4 Lever Mechanism
- 12 Differs

Code	Case	Finish
H0021501	64x38mm	Brass



Union 4137 Cupboard Lock

- Cylinder cut cupboard/drawer lock • 2 keys
- Suits timber drawers or doors up to 23mm thickness
- Cylinder rotates to produce either a drawer lock or a right or left hand cupboard lock

Code	Case	Finish
H0026201	64x38mm	Polished Brass Cylinder

Strike plate		Finish
Code		
H0026203		Polished Brass



Union 4138 Cupboard Lock

- Cylinder Cut Cupboard/Drawer Lock • 2 Keys
- Suits Timber Drawers Or Doors Up To 23mm thickness
- Cylinder Rotates To Produce Either A Drawer Lock Or A Right Or Left Hand Cupboard Lock

Code	Case	Finish
H0026202	64x38mm	Polished Brass

Strike plate		Finish
Code		
H0026203		Polished Brass



Union 4147 Cupboard Lock

- Cylinder Cut Cupboard/Drawer Lock • 2 Keys
- Suits Timber Drawers Or Doors Up To 12.5mm thickness
- Cylinder Rotates To Produce Either A Drawer Lock Or A Right Or Left Hand Cupboard Lock

Code	Case	Finish
H0026211	45x33mm	Polished Brass

Strike plate		Finish
Code		
H0026203		Polished Brass



Union 4148 Cupboard Lock

- Cylinder Cut Cupboard/Drawer Lock • 2 Keys
- Suits Timber Drawers Or Doors Up To 12.5mm thickness
- Cylinder Rotates To Produce Either A Drawer Lock Or A Right Or Left Hand Cupboard Lock • Upon Closing The Bolt Is Automatically Engaged

Code	Case	Finish
H0026221	45x33mm	Polished Brass

Strike plate		Finish
Code		
H0026203		Polished Brass



Thread Escutcheon

- To line a keyhole opening

Code	Case	Finish
H0330001	13mm	Brass
H0330011	14mm	Brass
H0330021	16mm	Brass



Locker Lock

- Deadbolt With 6mm Projection Nozzle
- 2 Keys
- 7 Lever Mechanism
- 1000 Differs
- Suits Metal Doors Up To 5mm Thickness

Code	Case	Finish
H0023001	43x67mm	Silver



Ratchet Lock

- Ratchet Lock For Pair Of Frameless Glass Doors
- 2 Keys

Code	Case	Finish
H0027501	114mm	Polished Chrome



Plunger Lock Glass

- Cylinder "Plunge" Sliding Door Lock For Glass Doors

Code	Dia	Finish
H00267001	19mm	Polished Chrome



Ratchet Lock Timber

- Cylinder "Plunge" Sliding Door Lock For Light Timber Doors

Code	Dia	Finish
H0026501	19mm	Polished Chrome



Mortice Budget Lock

- Mortice Budget Lock c/w Strikeplate

Code	Finish
H0522051	Sheradised

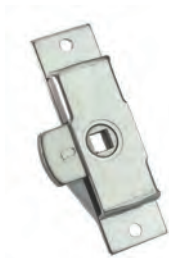

Rim Budget Lock

- Flat Rim Budget Lock c/w Strikeplate Double Handed

Code	Finish
H0045501	Bright Zinc Plated



Standard T Budget Lock Key

- Keys

Key Type	Code	Finish
Standard T Key	H0046001	Self Colour



Budget Lock Flat Oval Escutcheon

- Keys

Key Type	Code	Finish
Flat Oval Escutcheon	H0044501	Satin Chrome



Triangular Budget Lock Key

- Keys

Key Type	Code	Finish
Triangular	H4800020	Self Colour



N&C Triangular Budget Lock

- Triangular Key Rim Budget Lock c/w Nylon Ferrule & Plate

Code	Finish
H4800018	Self Colour



Budget Lock Covered Spring Escutcheon

- Keys

Key Type	Code	Finish
Covered Spring	H0045001	Chrome

Door Catches

A range of door catches suitable for varying applications such as kitchen doors, cabinet doors and other household furniture.

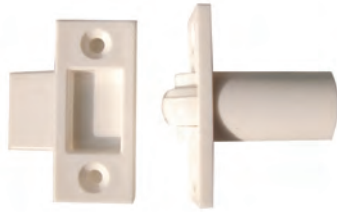

Nylon Roller Door Catch

- Nylon roller door catch ● Non adjustable

Code	Size	Finish
H0029001	27x18mm	White

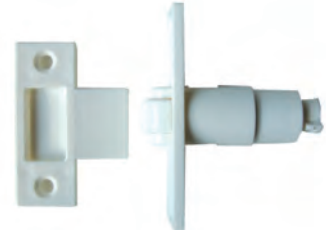

Nylon Roller Door Catch Adjustable

- Nylon roller door catch ● Adjustable

Code	Size	Finish
H0029002	54x19mm	White



Cupboard Catch

- Self aligning cupboard catch

Code	Size	Finish
H0029501	25x32mm	Zinc Plated



Ball Catch

- Brass ball catch

Code	Size	Finish
H0030001	6mm	Brass
H0030002	8mm	Brass
H0030003	10mm	Brass
H0030004	12mm	Brass



Bales Catch

- Brass bales catch

Code	Size	Finish
H0030502	12mm	Brass
H0030503	16mm	Brass



Double Ball Catch

- Brass double ball catch

Code	Size	Finish
H0031001	40mm	Brass
H0031002	50mm	Brass
H0031003	60mm	Brass
H0031004	70mm	Brass

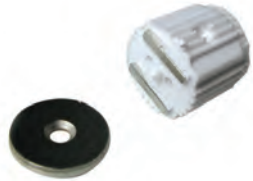

Magnetic Catch

- Mortice magnetic catch for medium weight cabinet doors

Code	Dia	Finish
H0031501	14mm	White



Surface Fix Magnetic Catch

- Fix magnetic catch for medium weight cabinet doors

Code	Size	Finish
H0033501	70x16mm	White
H0033502	48x16mm	White
H0033503	45x14mm	White



Hush Latch

- Use in conjunction with mortice latch & door closer to reduce "door slamming" noise

Code	Finish
H0034501	White



Adjustable Roller Door Catch

- Adjustable mortice roller bolt catch

Code	Size	Finish
H0040001	60x22mm	Polished Chrome
H0040002	60x22mm	Polished Brass



Cupboard Buttons

- Cupboard button

Code	Size	Finish
H0039001	25x32mm	Zinc Plated



Touch Latch

- "Press" the door to open or close

Code	Size	Finish
H0035501	75x13mm	Zinc Plated



N&C Camlock

- Conical head nut fixed camlock • Keyed to differ
- 2 keys • Locking nut & pronged washer

Code	Size	Finish
H0037000	1 6mm	Polished Chrome
H0037001	20mm	Polished Chrome
H0037002	20mm	Polished Chrome
H0037003	22mm	Polished Chrome
H0037004	24mm	Polished Chrome
H0037005	32mm	Polished Chrome



N&C Latchlock

- Conical head nut fixed latchlock • With locking nut
- (Camlock is operated by pushing the handle in to engage the cam mechanism then rotating through 180 degrees)
- Handle can be locked off in both open & closed position by fitting a padlock through the hole

Code	Size	Finish
H0037006	20mm	Polished Chrome



Radial Pin Camlock

- Square head nut fixed radial pin camlock
- Keyed to differ
- Supplied with 2 keys, locking nut & pronged washer
- Key not removeable in unlocked position

Code	Size	Finish
H0037007	18mm	Chrome
H0037008	22mm	Chrome
H0037009	30mm	Chrome

BeCode Keyless Locks

Created to overcome the frustrations associated with traditional locks, this keyless cable free solution is the perfect choice for existing furniture.

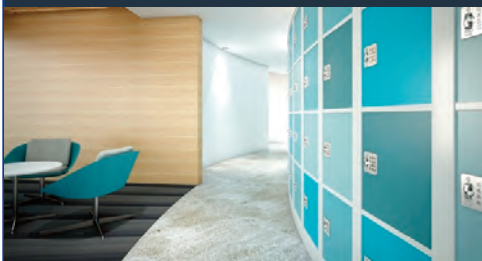

Evo+ for Cabinets & Lockers

- Digital multifunctional battery operated lock
- 6 operation modes including single or multi user
- Suitable for retro fit to existing locks • Battery included

Code	Dia	Finish
H0038500	52mm	White



BePad

- Digital multifunctional battery operated lock
- 6 operation modes including single or multi user
- Suitable for retro fit to existing locks • Battery Included

Code	Size	Finish
H0038520	104x98mm	White



Air+ RFID Proximity Lock

- Digital multifunctional battery operated lock
- 6 operation modes including single or multi user
- Includes integrated cam lock
- Suitable for retro fit to existing locks • Battery included

Code	Dia	Finish
H0038560	52mm	White



Air (Hafele) Proximity Lock

- Digital multifunctional battery operated lock
- 6 operation modes including single or multi user
- Includes integrated cam lock
- Suitable for retro fit to existing locks • Battery included

Code	Dia	Finish
H0038565	56mm	White



Air (Lehman) Proximity Lock

- Digital multifunctional battery operated lock
- 6 operation modes including single or multi user
- Includes integrated cam lock
- Suitable for retro fit to existing locks • Battery included

Code	Dia	Finish
H0038570	56mm	White

BeCode Accessories

Code	Description
H0038600	BeCode Hafele Adaptor "H"
H0038610	BeCode Hafele Adaptor "L"
H0038620	BeCode 40mm Cam Smooth
H0038622	BeCode 40mm Cam Angle 4mm
H0038624	BeCode 40mm Cam Angle 7mm
H0038626	BeCode Sleeve Press In Tool
H0038628	BeCode Press In Tool
H0038630	BeCode CR2450 Replacement Battery
H0038632	BeCode CR2477 Replacement Battery
H0038634	BeCode RFID Card MIFARE
H0038636	BeCode Tool Set
	Air Tensioner & Removal Tool Crown
H0038638	BeCode RFID Keyfob



Handles and Knobs

A range of contemporary and traditional designs to suit the vast majority of applications in a high quality satin nickel or chrome plated finish.



T Bar Handle

● T Bar cabinet handle on pillars ● Rear bolt fix

Code	Size	Centres	Finish
H0035730	156x10mm	96	Satin Stainless Steel
H0035731	188x10mm	128	Satin Stainless Steel
H0035732	20x10mm	160	Satin Stainless Steel



Quadra Bow Handle

● Quadra bow cabinet handle ● Rear bolt fix

Code	Size	Centres	Finish
H0035740	106x10mm	96	Satin Nickel



D Handle

● D cabinet handle on pillars ● Rear bolt fix

Code	Size	Finish
H0035710	106x10mm	Satin Nickel
H0035711	106x10mm	Polished Chrome
H0035712	138x10mm	Satin Nickel
H0035713	138x10mm	Polished Chrome
H0035714	170x10mm	Satin Nickel
H0035715	170x10mm	Polished Chrome
H0035716	202x10mm	Satin Nickel
H0035717	202x10mm	Polished Chrome
H0035718	234x10mm	Satin Nickel
H0035719	234x10mm	Polished Chrome
H0035720	298x10mm	Satin Nickel
H0035721	298x10mm	Polished Chrome
H0035722	330x10mm	Satin Nickel
H0035723	330x10mm	Polished Chrome
H0035724	352x10mm	Satin Nickel
H0035725	352x10mm	Polished Chrome



Keyhole Handle

● Keyhole profile cabinet handle on pillars ● Rear bolt fix

Code	Size	Centres	Finish
H0035701	140x12mm	128	Satin Nickel Chrome
H0035702	172x12mm	160	Satin Nickel Chrome
H0035703	204x12mm	192	Satin Nickel Chrome
H0035704	236x12mm	224	Satin Nickel Chrome
H0035705	460x12mm	448	Satin Nickel Chrome
H0035706	588x12mm	576	Satin Nickel Chrome



Curve Bow Handle

● Curve bow cabinet handle ● Rear bolt fix

Code	Size	Finish
H0035750	119x10mm	Satin Nickel
H0035751	119x10mm	Polished Chrome
H0035752	153x10mm	Satin Nickel
H0035753	153x10mm	Polished Chrome
H0035754	190x10mm	Satin Nickel
H0035755	190x10mm	Polished Chrome
H0035756	226x10mm	Satin Nickel
H0035757	226x10mm	Polished Chrome
H0035758	256x10mm	Satin Nickel
H0035759	256x10mm	Polished Chrome
H0035760	338x10mm	Satin Nickel
H0035761	338x10mm	Polished Chrome
H0035762	372x10mm	Satin Nickel
H0035763	372x10mm	Polished Chrome
H0035764	408x10mm	Satin Nickel
H0035765	408x10mm	Polished Chrome



Dimple Effect Knob

● Dimple effect cupboard knob ● Rear bolt fix

Code	Size	Finish
H0035810	28mm	Satin Nickel
H0035811	28mm	Polished Chrome
H0035812	33mm	Satin Nickel
H0035813	33mm	Polished Chrome



Cylindrical Knob

● Cupboard knob with finger notch ● Rear bolt fix

Code	Size	Finish
H0035820	16mm	Satin Stainless Steel
H0035821	16mm	Polished Stainless Steel
H0035822	20mm	Satin Stainless Steel
H0035823	20mm	Polished Stainless Steel
H0035824	25mm	Satin Stainless Steel
H0035825	25mm	Polished Stainless Steel
H0035826	30mm	Satin Stainless Steel
H0035827	30mm	Polished Stainless Steel



Dimple Effect Handle

● Curved cabinet handle on pillars ● Rear bolt fix

Code	Size	Centres	Finish
H0035770	122mm	96	Satin Nickel
H0035771	122mm	96	Polished Chrome
H0035772	156mm	128	Satin Nickel
H0035773	156mm	128	Polished Chrome



Victorian Cupboard Knob

● Cupboard knob ● Rear bolt fix

Code	Size	Finish
H0035790	25mm	Satin Chrome
H0035791	25mm	Polished Chrome
H0035792	25mm	Polished Brass
H0035793	25mm	Stainless Steel Effect
H0035794	32mm	Satin Chrome
H0035795	32mm	Polished Chrome
H0035796	32mm	Polished Brass
H0035797	32mm	Stainless Steel Effect
H0035798	38mm	Satin Chrome
H0035799	38mm	Polished Chrome
H0035800	38mm	Polished Brass
H0035801	38mm	Stainless Steel Effect



Steel Cage Handle

● Drop cabinet handle ● Rear bolt fix

Code	Size	Finish
H0035830	142mm	Antique Steel
H0035831	181mm	Antique Steel



Steel Cage Fixed Handle

● Steel cage fixed cabinet handle ● Rear bolt fix

Code	Size	Finish
H0035840	136mm	Satin Nickel
H0035841	168mm	Antique Steel



Steel Cage Knob

● Steel cage ball cupboard knob ● Rear bolt fix

Code	Size	Finish
H0035870	34mm	Antique Steel
H0035871	42mm	Antique Steel



Steel Cage Mushroom Cupboard Knob

● Steel cage mushroom cupboard knob ● Rear bolt fix

Code	Size	Finish
H0035880	34mm	Antique Steel
H0035881	44mm	Antique Steel



Steel Cage Oval Cupboard Knob

● Steel cage oval cupboard knob ● Rear bolt fix

Code	Size	Finish
H0035890	55mm	Antique Steel
H0035891	65mm	Antique Steel



Chest Handle

● Steel chest handle on plate ● Dcsk for screw fix

Code	Size	Finish
H0659001	102mm	Black Japanned



Card Frame

● Brass card frame for paper/card insert ● Screw fix

Code	Size	Finish
H0627001	67x25mm	Brass
H0627011	42mm	Brass

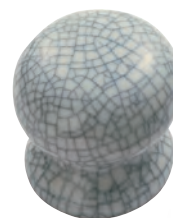

Porcelain Knob

● Porcelain cupboard knob ● Rear bolt fix

Code	Size	Finish
H0035850	30mm	Ivory Crackle Glaze
H0035851	30mm	Blue Crackle Glaze
H0035852	30mm	Plain Ivory
H0035853	30mm	Plain White
H0035854	35mm	Ivory Crackle Glaze
H0035855	35mm	Blue Crackle Glaze
H0035856	35mm	Plain Ivory
H0035857	35mm	Plain White
H0035858	45mm	Ivory Crackle Glaze
H0035859	45mm	Blue Crackle Glaze
H0035860	45mm	Plain Ivory
H0035861	45mm	Plain White



Flush Lifting Handle

- Flush lifting handle ● Dcsk for screw fix

Code	Size	Finish
H0626501	76x48mm	Polished Brass
H0626502	76x48mm	Polished Chrome



Squash Court Handle

- Fully flush with finger recess ● Dcsk for screw fix

Code	Size	Finish
H0610501	90x90mm	Polished Brass
H0610502	90x90mm	Polished Chrome



Flush Spring Catch

- Flush spring catch with keep ● Dcsk for screw fix

Code	Size	Finish
H0611001	51x38mm	Polished Brass



Flush Ring Handle

- Flush ring mortice handle ● Dcsk for screw fix

Code	Size	Finish
H0611501	76x76mm	Polished Brass



Flush Ring

- Flush ring ● Dcsk for screw fix

Code	Size	Finish
H0612001	51x38mm	Polished Brass
H0612011	64x51mm	Polished Brass

Did you know?

Nicholls & Clarke have been supplying Architectural and builders ironmongery since 1880, servicing the capitals construction trade from the heart of London.



Soft Close Cabinet Hinge Inset

- Concealed soft close cabinet hinge inset
- 110° opening

Code	Size	Finish
H0035990	35mm	Nickel Plated



Soft Close Cabinet Hinge Half Overlay

- Concealed soft close cabinet hinge half overlay
- 110° opening

Code	Size	Finish
H0035991	35mm	Nickel Plated



Soft Close Cabinet Hinge Half Overlay

- Concealed soft close cabinet hinge half overlay
- 110° opening

Code	Size	Finish
H0035992	35mm	Nickel Plated

Mounting Plate

- Plate for concealed soft close cabinet hinge 0mm

Code	Size	Finish
H0035993	44x50mm	Nickel Plated
H0035994	44x50mm	Nickel Plated
Adjustable Plate		
H0035995	44x55mm	Nickel Plated

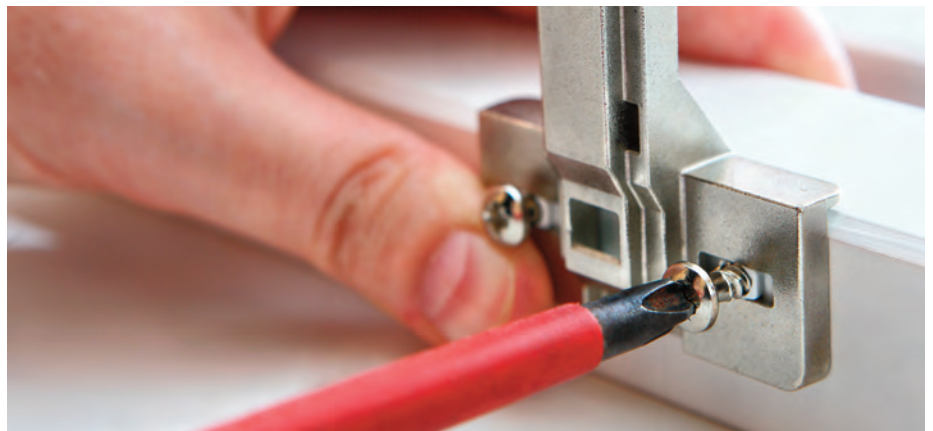

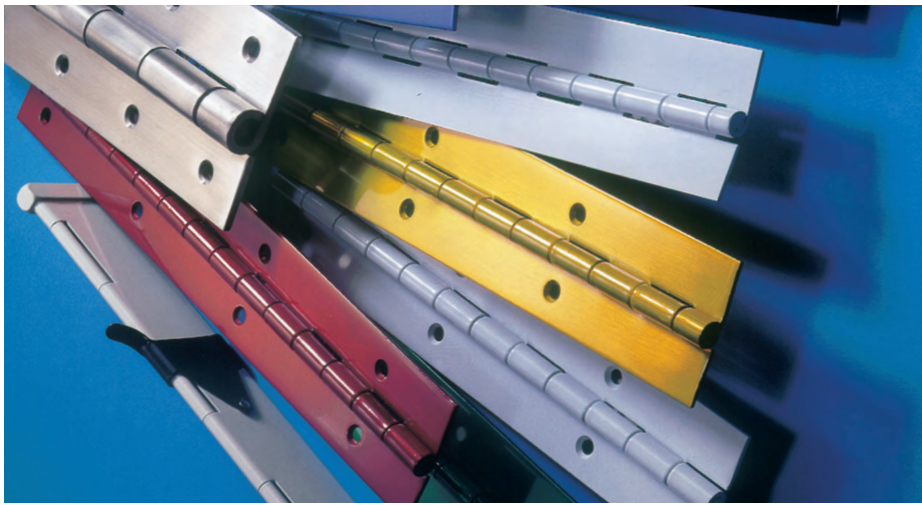

N&C Steel Piano Hinge

• Continuous steel piano hinge • 0.66mm thickness

Code	Size	Finish
H0452501	1800x25mm	Electro Brass
H0452503	1800x32mm	Electro Brass
H0452505	1800x38mm	Electro Brass
H0452502	1800x25mm	Nickel Plated
H0452504	1800x32mm	Nickel Plated
H0452506	1800x38mm	Nickel Plated



Concealed Soss Brass Hinges

Code	Door Thickness	Finish
• Pattern 203		
H0453001	19mm	Self Colour Brass
• Pattern 208		
H0453011	70x16mm	Self Colour Brass
• Pattern 216		
H0453021	117x25mm	Self Colour Brass
• Pattern 218		
H0453031	117x28mm	Self Colour Brass
• Pattern 220		
H0453041	140x35mm	Self Colour Brass

Please refer to Soss hinge selection criteria in the 'Hinges' section



Wardrobe Rail 19mm Dia

• Steel wardrobe hanging rail 19mm diameter

Code	Length	Finish
H8090001	610mm	Polished Chrome Plated
H8090002	915mm	Polished Chrome Plated
H8090003	1220mm	Polished Chrome Plated
H8090004	1525mm	Polished Chrome Plated
H8090005	1838mm	Polished Chrome Plated
H8090006	2500mm	Polished Chrome Plated
H8080001	610mm	Polished Brass Plated
H8080002	915mm	Polished Brass Plated
H8080003	1220mm	Polished Brass Plated
H8080004	1525mm	Polished Brass Plated
H8080005	1838mm	Polished Brass Plated
H8080006	2500mm	Polished Brass Plated

Wardrobe Rail 25mm Dia

• Steel wardrobe hanging rail 25mm diameter

Code	Length	Finish
H8090101	610mm	Polished Chrome Plated
H8090102	915mm	Polished Chrome Plated
H8090103	1220mm	Polished Chrome Plated
H8090104	1525mm	Polished Chrome Plated
H8090105	1838mm	Polished Chrome Plated
H8090106	2500mm	Polished Chrome Plated
H8080101	610mm	Polished Brass Plated
H8080102	915mm	Polished Brass Plated
H8080103	1220mm	Polished Brass Plated
H8080104	1525mm	Polished Brass Plated
H8080105	1838mm	Polished Brass Plated
H8080106	2500mm	Polished Brass Plated



Wardrobe Rail Centre Bracket

• Centre bracket for wardrobe hanging rail

Code	Dia	Finish
H8090011	19mm	Polished Chrome Plated
H8080011	19mm	Polished Brass Plated
H8090111	25mm	Polished Chrome Plated
H8080111	25mm	Polished Brass Plated



Wardrobe Socket

• Wardrobe socket for wardrobe hanging rail

Code	Dia	Finish
H8090021	19mm	Polished Chrome Plated
H8080021	19mm	Polished Brass Plated
H8090121	25mm	Polished Chrome Plated
H8080121	25mm	Polished Brass Plated



Ball End Bracket

• Ball end bracket for wardrobe hanging rail

Code	Dia	Finish
H8090031	19mm	Polished Chrome Plated
H8080031	19mm	Polished Brass Plated
H8090131	25mm	Polished Chrome Plated
H8080131	25mm	Polished Brass Plated



Through Bracket

• Through bracket for wardrobe hanging rail

Code	Dia	Finish
H8090041	19mm	Polished Chrome Plated
H8080041	19mm	Polished Brass Plated
H8090141	25mm	Polished Chrome Plated
H8080141	25mm	Polished Brass Plated

Shelving

Our unique, N&C heavy duty twin slot shelving system features a drop and lock safety protection, preventing the bracket from accidentally being dislodged. Our shelving units are perfect for use within hospitals, schools, universities, local authorities, offices and a range of other commercial applications.



N&C Heavy Duty Twin Slot Shelving Upright

- Twin slot upright
- Wall mounted
- Steel adjustable
- Anti bacterial powder coated

Code	Size	Finish
H0760001	430mm	White
H0760011	710mm	White
H0760021	1000mm	White
H0760031	1220mm	White
H0760041	1600mm	White
H0760051	1980mm	White
H0760061	2400mm	White

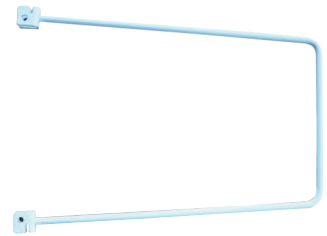

N&C Heavy Duty Twin Slot Shelving Bracket

- Twin slot bracket
- Upright mounted
- Steel adjustable
- Anti bacterial powder coated

Code	Size	Finish
H0760501	120mm	White
H0760511	170mm	White
H0760521	220mm	White
H0760531	270mm	White
H0760541	320mm	White
H0760551	360mm	White
H0760571	470mm	White
H0760581	610mm	White

N&C Heavy Duty Twin Slot Shelf End

- Twin slot shelf end
- Upright mounted
- Steel adjustable
- Anti bacterial powder coated

Code	Size	Hand	Finish
H0762501	152x152mm	Left	White
H0762511	152x152mm	Right	White
H0762521	203x152mm	Left	White
H0762531	203x152mm	Right	White
H0762541	254x152mm	Left	White
H0762551	254x152mm	Right	White

N&C Heavy Duty Twin Slot Rod Bookend

- Twin slot upright mounted spring rod bookend
- Steel adjustable
- Anti bacterial powder coated

Code	Size	Finish
H0764001	152x152mm	White
H0764011	203x152mm	White
H0764021	254x152mm	White



N&C Heavy Duty Twin Slot Rod Bookend

- Twin slot upright mounted spring rod bookend
- Steel adjustable
- Anti bacterial powder coated

Code	Size	Finish
H0763001	130x130mm	White

Melamine Board Shelf

- 15mm Thickness
- 2440mm Length

Code	Size	Finish
Z4033509	152mm	White
Z4033510	229mm	White
Z4033511	305mm	White
Z4033512	381mm	White
Z4033513	457mm	White
Z4033514	533mm	White
Z4033515	610mm	White
Z4033517	762mm	White





Flush Fitting Bookcase Strip

- 1829mm Lengths
- Traditional flush fitting bookcase strip
- Pre machined stepped grooves to the inside faces of the cabinet

Code	Width	Thickness	Finish
H0776001	19mm	3mm	Zinc Plated
H0776002	19mm	3mm	Bronzed
H0776003	19mm	3mm	Brass Plated
H0776004	19mm </td <td>3mm</td> <td>Silver Anodised</td>	3mm	Silver Anodised



Universal Fitting Bookcase Strip

- 1829mm lengths
- Raised bookcase strip
- For pre machined stepped grooves

Code	Width	Thickness	Finish
H0777001	19mm	5mm	Zinc Plated
H0777002	19mm	5mm	Bronzed
H0777003	19mm	5mm	Brass Plated
H0777004	19mm	5mm	Silver Anodised

When using universal surface mounted bookcase strip, shelving must be a minimum of 11mm shorter overall than the internal width of the cabinet.



Single Support Stud

- One slot fixing single support stud
- (Pack Of 10)

Code	Width	Finish
H0776501	19mm	Zinc Plated
H0776502	19mm	Bronzed
H0776503	19mm	Brass Plated

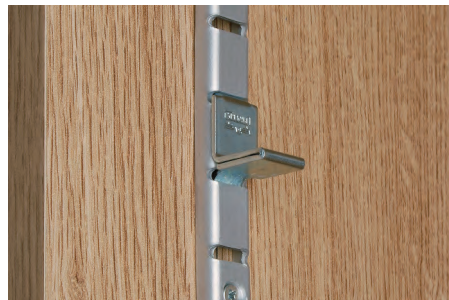

Double Support Stud

- Two slot fixing double support stud
- (Pack Of 10)

Code	Width	Finish
H0776511	19mm	Zinc Plated
H0776512	19mm	Bronzed
H0776513	19mm	Brass Plated



Rubber Shelf Buffer

- For glass shelves
- (Pack Of 10)
- Use with one slot fixing single support stud
- Reduces risk of slippage or movement

Code	Depth	Finish
H0776551	4mm	Black



Shelf Supports

- Banjo "Plug In" Shelf Support

Code	Width	Finish
H0775501	19mm	Brass Plated

Shelf Sockets

- Banjo "Plug In" Shelf Sockets

Code	Finish
H0775511	Brass Plated



Shelf Brackets

Code	Width	Finish
H0770501	200x200mm	White
H0770511	250x250mm	White
H0770521	300x300mm	White
H0770531	350x350mm	White



"London" Pattern Shelf Bracket

Code	Width	Finish
H0773501	100x75mm	Grey
H0773511	125x100mm	Grey
H0773521	150x125mm	Grey
H0773531	200x150mm	Grey
H0773541	225x175mm	Grey
H0773551	255x205mm	Grey
H0773561	305x255mm	Grey
H0773571	355x305mm	Grey

Cubicle Fittings

N&C offer a broad range of hardware for cubicle doors and panels in a durable, corrosion resistant standard grade 304 stainless steel.



Adjustable Foot Assemblies (Leg Support)

- Adjustable 150mm - 180mm in height
- 32mm Dia
- Wood screws & plastic plugs

Code	Board Thickness	Finish
H2240001	13mm	Satin Stainless Steel
H2240002	20mm	Satin Stainless Steel



Adjustable Foot Assemblies (Leg Support)

- Base Packing Pieces Supplied For Uneven Floors
- Wood Screws & Plastic Plugs

Code	Dia	Finish
H2240012	32mm	Satin Stainless Steel



L Bracket

- Countersunk Bolt Through Fixing
- Wood Screws & Plastic Plugs
- Suitable For 20mm Board Thickness

Code	Size	Finish
H2240020	50x40mm	Satin Stainless Steel



U Bracket

- Countersunk Bolt Through Fixing
- Wood Screws & Plastic Plugs

Suitable For 13mm Board Thickness

Code	Size	Finish
H2240021	50x40mm	Satin Stainless Steel

Suitable For 20mm Board Thickness

H2240022	50x40mm	Satin Stainless Steel
----------	---------	-----------------------



Gravity Hinges

- Adjustable On Site To Hold Open Or Hold Closed
- Suitable For 13mm & 20mm Board Thickness

Code	Width	Hand	Finish
H0444801	80x75mm	Left	Satin Stainless Steel
H0444811	80x75mm	Right	Satin Stainless Steel



Indicator Bolt

- Indicator Bolt Surface Mounted
- External Red/White Indicator With Emergency Release
- Concealed Bolt Through Fixings
- Suitable For 13mm & 20mm Board Thickness

Code	Size	Finish
H2240031	76x42mm	Satin Stainless Steel



Bolt Keep Inwards Opening Doors

- Angle Keep For H2240031
- Woodscrews Supplied

Suitable For 13mm Board Thickness

Code	Size	Finish
H2240041	40x42mm	Satin Stainless Steel

Suitable For 20mm Board Thickness

H2240042	40x42mm	Satin Stainless Steel
----------	---------	-----------------------



Fixing Packs

- Woodscrew Fixing Pack For Gravity Hinges

Code	Finish
H0444815	Satin Stainless Steel

- Bolt Through Fixing Pack For Gravity Hinges

Code	Finish
H0444816	Satin Stainless Steel

- Spare Countersunk Bolt Through Fixings

Code	Finish
	Satin Stainless Steel

We recommend marine grade 316 stainless steel as having better corrosion resistance for polluted, coastal or Chloride environments such as swimming pools. Please contact the sales office for further advice.

Window Fittings

Over the years, traditional windows have been replaced with more energy efficient, modern windows. At N&C, we offer a range of traditional style windows fittings for modern windows. These include side hung timber casement windows, top hung timber fanlights and vertical sliding sash and pivot windows.

TRADITIONAL WINDOW FITTINGS

A wide range of window fittings such as casement stays, fasteners, pulleys and catches with an authentic traditional style, created for modern windows.

WINDOW WINDING GEAR

We offer manual or electric window operation which offer direct opening and closing of single or banks of windows in awkward or out of reach positions.

WINDOW VENTS

A complete range of quality glass mounted ventilators with a patented diffusing rotor system for the prevention of severe draughts.





Victorian Casement Stay 2 Pins

Code	Size	Finish	Code	Size	Finish
H8000125	200mm	Polished Brass	H8000302	200mm	Chrome
H8000126	250mm	Polished Brass	H8002027	250mm	Chrome
H8000127	300mm	Polished Brass	H8002028	300mm	Chrome
H8000300	200mm	Polished Chrome			
H8001034	250mm	Polished Chrome			
H8001035	300mm	Polished Chrome			

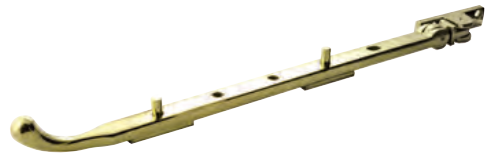

Bulb End Casement Stay 2 Pins

Code	Size	Finish	Code	Size	Finish
H8000310	200mm	Polished Brass	H8000315	200mm	Chrome
H8000123	250mm	Polished Brass	H8000316	250mm	Chrome
H8000124	300mm	Polished Brass	H8000317	300mm	Chrome
H8000312	200mm	Polished Chrome			
H8000313	250mm	Polished Chrome			
H8000314	300mm	Polished Chrome			



Monkey Tail Pattern Casement 2 Pins

Code	Size	Finish
H8070044	200mm	Antique Black
H8070046	250mm	Antique Black
H8070047	300mm	Antique Black



Contemporary Square Non Lockable Casement Stay 2 Pins

● Supplied With Both Flat & EJMA Fittings

Code	Size	Finish
H8200203	250mm	Brass
H8200201	250mm	Chrome
H8200202	250mm	White



Contemporary Square Lockable Casement Stay 2 Pins With Key

● Supplied With Both Flat & EJMA Fittings

Code	Size	Finish	Code	Size	Finish
H8200303	250mm	Brass	H8200302	250mm	White
H8200301	250mm	Chrome	H8200303	250mm	Polished Brass



Contemporary Round Casement Stay 2 Pins

Code	Size	Finish	Code	Size	Finish
H8200601	250mm	Polished Brass	H8200603	250mm	Satin Chrome
H8200602	250mm	Polished Chrome	H8200604	250mm	Satin Nickel



Die Cast Casement Stay 2 Pins

Code	Size	Finish
H0500001	200mm	Grey
H0500015	255mm	Grey
H0500021	305mm	Grey



Aluminium Casement Stay 2 Pins

Code	Size	Finish
H0500501	200mm	Satin Anodised Aluminum
H0500511	255mm	Satin Anodised Aluminum
H0500521	305mm	Satin Anodised Aluminum



All products are suitable for domestic use



Double Arm Casement Stay

- "Screw Down" Knob

Code	Size	Finish
H0501501	200mm	Satin Anodised Aluminum
H0501511	255mm	Satin Anodised Aluminum
H0501521	305mm	Satin Anodised Aluminum



Brass Sliding Casement Stay Outward Opening

- Outward Opening Window
- "Screw Down" Knob

Code	Size	Finish	Code	Size	Finish
H0504001	255mm	Polished Brass	H0504003	255mm	Satin Chrome
H0504011	305mm	Polished Brass	H0504013	305mm	Satin Chrome



Sliding Brass Sliding Casement Stay Inward Opening

- Inward Opening Window
- "Screw Down" Knob

Code	Size	Finish
H0504501	255mm	Polished Brass
H0504511	305mm	Polished Brass



Straight Casement Stay Pin Only

- Pin Only

Code	Finish
H0513504	Grey Die Cast
H0513505	Polished Brass
H0513503	Satin Anodised Aluminum



Offset Casement Stay Pin Only

- Pin Only

Code	Finish
H0514001	Grey Die Cast
H0514502	Polished Brass
H0514503	Satin Anodised Aluminum



Cranked Casement Stay Pin Only

- Pin Only

Code	Finish
H0514502	Polished Brass
H0514503	Satin Anodised Aluminum



Victorian Casement Fastener

- Hook & Mortice Pattern Reversible

Code	Size	Finish
H8000038	90mm	Polished Brass
H8000115	90mm	Polished Brass
H8001033		Polished Chrome
H8002050		Satin Chrome



Bulb End Casement Fastener

- Hook & Mortice Pattern Reversible

Code	Finish
H8000117	Polished Brass
H8000320	Polished Chrome
H8002052	Satin Chrome



Monkey Tail Pattern Casement Fastener

- Hook & Mortice Pattern Reversible

Code	Size	Finish
H8070045		Antique Black



All products are suitable for domestic use



Contemporary Square Non Lockable Casement Fastener

- Both flat & EJMA fittings reversible

Code	Size	Finish
H8200403	120mm	Brass
H8200401	120mm	Chrome
H8200402	120mm	White



Contemporary Square Lockable Casement Fastener

- Both flat & EJMA fittings reversible

Code	Size	Finish
H8200503	120mm	Brass
H8200501	120mm	Chrome
H8200502	120mm	White



Contemporary Round Casement Fastener

- Hook & mortice pattern reversible

Code	Size	Finish
H8200620	115mm	Polished Brass
H8200621	115mm	Polished Chrome
H8200622	115mm	Satin Chrome
H8200623	115mm	Satin Nickel



Die Cast Casement Fastener MP

- Mortice pattern reversible

Code	Finish
H0510551	Grey



Die Cast Casement Fastener HP

- Hook pattern reversible

Code	Finish
H0510561	Grey



Aluminium Casement Fastener

- Mortice plate. Spacing backplate avoids over tightening

Code	Hand	Backplate	Finish
H0511501	Right	73x25mm	Satin Anodised Aluminium
H0511511	Left	73x25mm	Satin Anodised Aluminium



Jackloc Window Restrictor

- Jackloc cable key locking window restrictor

Code	Size	Finish
H0122503	200mm	White
H0122504	200mm	Brass
H0122505	200mm	Chrome



Sliplock Window Restrictor

- Sliplock cable key locking window restrictor

Code	Size	Finish
H0122510		White



Sash Axle Pulley Nylon Wheel

- Steel square cornered face plate
- Curved wheel for use with sash cord

Code	Wheel	Size	Finish
H0550001	44mm	117x25mm	Bright Zinc Plated
H0550002	44mm	117x25mm	Galvanised
H0551001	44mm	110x25mm	Galvanised
H0551002	44mm	110x25mm	Brass



Sash Axle Pulley Brass Wheel

- Steel square cornered face plate
- Curved wheel for use with sash cord

Code	Wheel	Size	Finish
H0551501	44mm	126x28mm	Galvanised
H0551502	44mm	126x28mm	Brass



Sash Axle Pulley Brass Wheel

- Steel square cornered face plate
- Curved wheel for use with sash cord

Code	Wheel	Size	Finish
H0551511	51mm	126x28mm	Galvanised
H0551512	51mm	126x28mm	Brass



Sash Axle Pulley Brass Wheel

- Steel square cornered face plate
- Curved wheel for use with sash cord

Code	Wheel	Size	Finish
H0551521	57mm	126x28mm	Galvanised
H0551522	57mm	126x28mm	Brass



Jute Sash Cord

- 10 metre knot

Code	Size	Finish
H0555001	Size 3	Natural
H0555011	Size 4	Natural
H0555021	Size 5	Natural



Nylon Sash Cord

- 10 metre knot

Code	Size	Finish
H0556001	Size 3	White
H0556011	Size 4	White
H0556021	Size 5	White
H0556031	Size 6	White



Blue Label Sash Cord

- Everlasto waterproof blue label sash cord
- 10 metre knot

Code	Size	Finish
H0557001	Size 3	Waxed
H0557011	Size 4	Waxed
H0557021	Size 5	Waxed
H0557031	Size 6	Waxed



Red Label Sash Cord

- Everlasto waterproof red label "a" quality sash cord
- 10 metre knot

Code	Size	Finish
H0557501	Size 3	Waxed
H0557511	Size 4	Waxed
H0557521	Size 5	Waxed
H0557531	Size 6	Waxed



Red Spot Sash Cord

- Solid braided red spot sash cord
- 10 metre knot

Code	Size	Finish
H0556501	Size 6	Polished
H0556511	Size 7	Polished
H0556521	Size 8	Polished



Sash Chain

- Steel link sash chain with bronze rivets

Code	Weight Limit	Finish
H0552001	32kg	Bright Zinc Plated
H0552011	51kg	Bright Zinc Plated



Sash Chain Split Pin Connector

- Washer & split pin connector
- (Set Of 4)

Code
H0552501



Sash Weight Bolt Connector

- Sash weight bolt connector
- (Set Of 4)

Code
H0553001



Sash Weight Loop Connector

- Loop weight connector
- (Set Of 4)

Code
H0553501



Sash Plates & Bars

- Sash plates & bars
- (Set Of 4)

Code
H0554001



Sash Weights Makeweight

- Cast iron round makeweight

Code	Weight
C3120001	1/2 lb
C3120002	1 lb
C3120003	2 lb



Sashweight Round

- Cast iron sashweight

Code	Weight
C3120502	2 lb
C3120503	3 lb
C3120504	4 lb
C3120505	5 lb
C3120506	6 lb
C3120507	7 lb
C3120508	8 lb
C3120509	9 lb
C3120510	10 lb
C3120511	11 lb
C3120512	12 lb
C3120513	13 lb



Sashweight Square

- Cast Iron Sashweight

Code	Weight
C3120515	15 lb
C3120516	16 lb
C3120517	17 lb
C3120518	18 lb
C3120519	19 lb
C3120520	20 lb
C3120521	21 lb
C3120522	22 lb
C3120523	23 lb
C3120524	24 lb
C3120525	25 lb
C3120526	26 lb
C3120527	27 lb
C3120528	28 lb
C3120529	29 lb
C3120530	30 lb



Narrow Pattern Fitch Fastener Non Locking

- Narrow pattern fitch fastener non locking

Code	Size	Finish
H8000132	65mm	Polished Brass
H8001039	65mm	Polished Chrome
H8002035	65mm	Satin Chrome



Narrow Pattern Fitch Fastener Locking

- Narrow pattern fitch fastener non locking

Code	Size	Finish
H8000133	65mm	Polished Brass
H8001068	65mm	Polished Chrome
H8002038	65mm	Satin Chrome



Brighton Sash Fastener

- Brighton pattern sash fastener

Code	Size	Finish
H8000043	55mm	Polished Brass
H8001038	55mm	Polished Chrome
H8002034	55mm	Satin Chrome
H0532001	55mm	Bright Zinc Plated
H0532003	55mm	Electro Brass Plated



Quadrant Arm Sash Fastener

- Quadrant arm sash fastener

Code	Size	Finish
H8000041	70mm	Polished Brass
H8001036	70mm	Polished Chrome
H8002029	70mm	Satin Chrome



Acorn Sash Stop On Chain

- Acorn sash stop on chain

Code	Size	Finish
H0534001	32x13mm	Brass

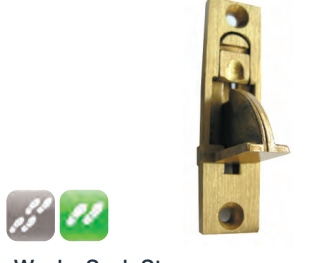

Weeks Sash Stop

- Weeks pattern weighted sash stop

Code	Finish
H0534501	Brass



Sash Screw

- Centre rail sash screw

Code	Size	Finish
H0535001	64x6mm	Polished Brass
H0535011	76x8mm	Polished Brass
H0535021	89x8mm	Polished Brass



Sash Lift

Code	Size	Finish
H8000042	50mm	Polished Brass
H8001037	50mm	Polished Chrome
H8002030	50mm	Satin Chrome



Strong Sash Lift

Code	Size	Finish
H0545001	64mm	Polished Brass
H0545003	64mm	Polished Chrome
H0545002	64mm	Satin Chrome



Sash Handle

Code	Size	Finish
H8001081	102mm	Polished Brass
H8001082	125mm	Polished Brass
H8001083	152mm	Polished Brass
H8001059	102mm	Polished Chrome
H8001060	125mm	Polished Chrome
H8001040	152mm	Polished Chrome
H0545010	102mm	Satin Chrome
H0545011	125mm	Satin Chrome
H0545012	152mm	Satin Chrome



Meakins Sash Window Operator

- Set Comprising: Fastener - 2 pulleys - 2 cord plates - 4 handles - 8 yards of cord - fixings

Code	Finish
H0535501	Polished Brass



Meakins Sash Window Operator Individual Components

Code	Finish
H0535521	Pulleys
H0535531	Cord Plates
H0535541	Handles
H0535551	Cord



Fanlight Catch

• Sprung fanlight catch with ring & staple

Code	Size	Finish
H8000046	56x38mm	Polished Brass
H8000400	56x38mm	Polished Chrome
H8000401	56x38mm	Satin Chrome



Shadbolt Stays

Code	Size	Finish
H0521001	203mm	Brass
H0521011	255mm	Brass



Window Pivots

• (Set of 4 Pieces)

Code	Size	Finish
H0533001	38x13mm	Brass
H0533011	51x22mm	Brass
H0533511	64x25mm	Brass



"Bullet" Fanlight Catch

• "Bullet" Pattern Sprung Fanlight Catch With Ring & Staple

Code	Size	Finish
H8000045	36mm	Polished Brass
H8000410	36mm	Polished Chrome
H8000411	36mm	Satin Chrome



Sash Pole Hook

• (Set of 4 Pieces)

Code	Finish
H0613003	Polished Brass
H0613004	Polished Chrome
H0613005	Satin Chrome



Sash Pole

• Wooden Long Arm Pole

Code	Size
H0613501	1350x30mm
H0613511	1850x30mm



Quadrant Arm Stays

• (Sold In Pairs)

Code	Size	Finish
H8000450	152mm	Polished Brass
H8000451	152mm	Polished Chrome
H8000452	152mm	Satin Chrome



Roller Arm Stays

• (Sold In Pairs)

Code	Size	Finish
H8000456	200mm	Polished Brass
H8000457	200mm	Polished Chrome
H8000458	200mm	Satin Chrome



Endless Cord 4mm

• "B" Medium quality

Code	Drop	Finish
H0528001	1200mm	Green
H0528011	1500mm	Green
H0528021	2000mm	Green
H0528031	2500mm	Green
H0528041	3000mm	Green
H0528051	4000mm	Green
H0528061	5000mm	Green



Endless Cord 5mm

• "D" Medium quality

Code	Drop	Finish
H0528501	3000mm	Green
H0528511	4000mm	Green
H0528521	5000mm	Green
H0528531	6000mm	Green
H0528541	7000mm	Green

Spiral Sash Balances

N&C offer a wide range of spiral sash balances for both commercial and domestic applications.

Sash balances are designed to counter balance a sash, holding it in any position. We offer a variety of tube, lengths, diameters, colours and fixings, usually determined by the size & weight of the sash, with the spring balances being pre-tensioned with minimal on site adjustment.

Whilst balances are not designed as a mechanical opening device they do provide a degree of assistance when operating the window.

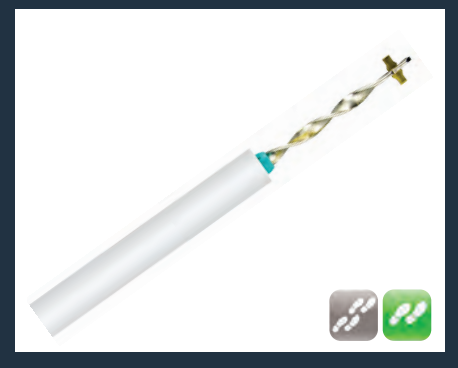

Manual Window Control



Manual window controls can be used on most styles of windows to operate individual or multiple sets from a single wall mounted operator connected by conduit with inner cable to the opener on the window. When the handle is turned the inner cable is driven forward or backwards, thus opening or closing the window.

This system is extremely flexible as the conduit can be bent around obstacles to achieve your required design.

Design Rules

One chain opener per window up to 1000mm wide - over this size two openers are required. The sum of openers and bends must not exceed six.

The length of conduit and cable must not exceed 18 metres. Above this it is necessary to provide additional control units.

Five Saddle Brackets are recommended for each metre of conduit.



All manual window winding products are suitable for commercial, domestic, educational environments and people with different levels of abilities

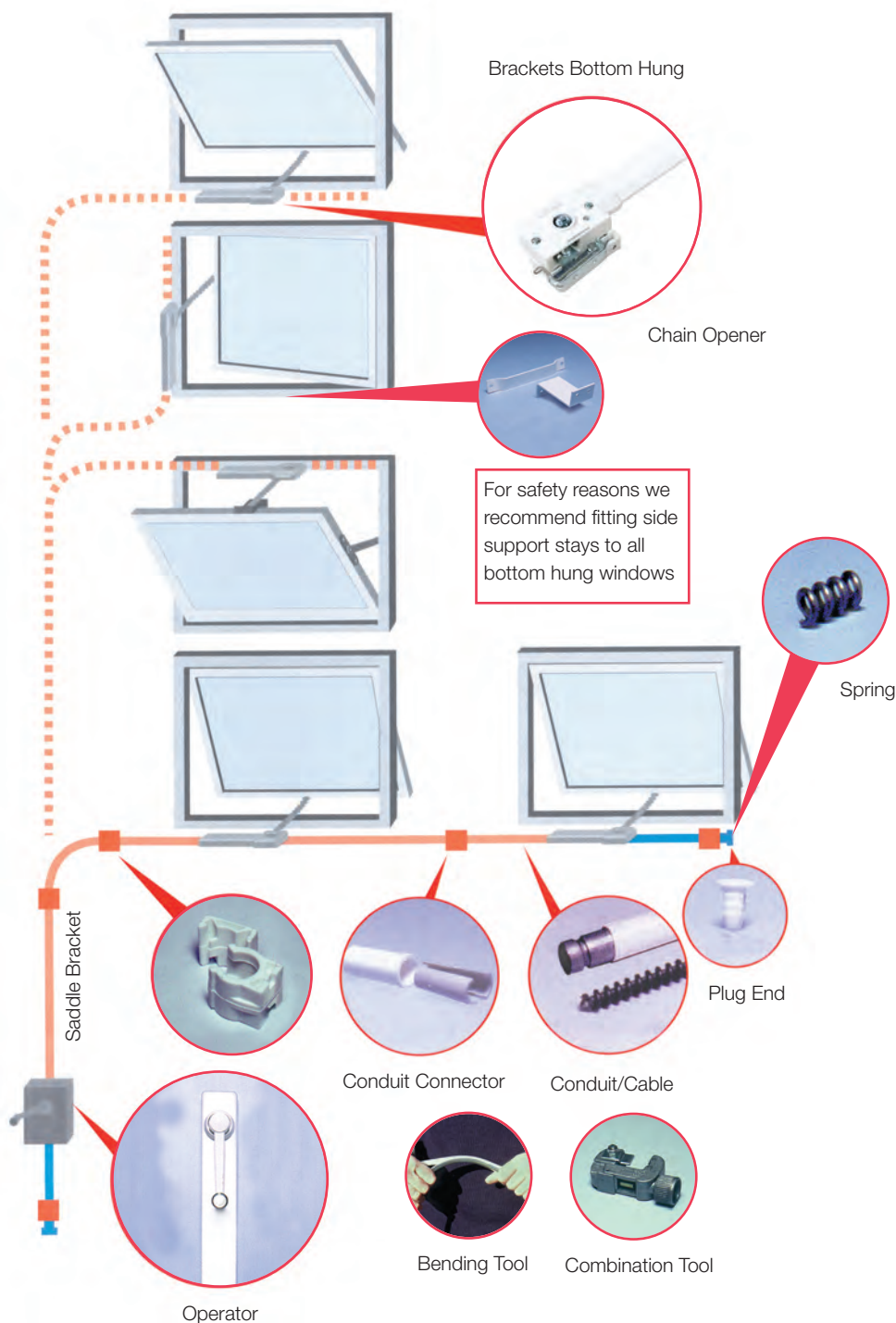

T100 Opener

- Chain Opener For Top, Side Or Bottom Hung Sashes
- Max Window Width 1000mm ● Window Opens to 250mm

Code	Size	Finish
H3400501	225x64mm	White



T250 Operator

- Handle Geared Operator For Up To 4 Chain Openers
- Spent Travel Of Drive Cable Is Housed In Casing

Code	Size	Finish
H3400001	385x45mm	White



T740 Fixing Plate

- Narrow Flat Fixing Plate
- For aluminium Frames Outward Opening

Code	Size	Finish
H3400002	115x20mm	White



T750 Fixing Plate

- Wide flat fixing plate
- For upvc frames outward opening

Code	Size	Finish
H3405002	76x40mm	White



T760 Fixing Plate

- angled fixing plate
- For timber frames outward opening

Code	Size	Finish
H3405004	115x25x25mm	White

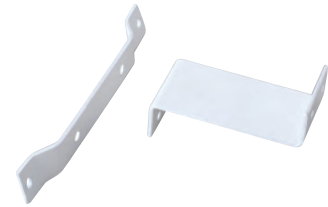

T850 Adaptor Kit

- Adaptor kit (bracket)
- Bottom hung inward opening window

Code	Size	Finish
H3401001	153mm	White



T400 Conduit

- Plastic covered metal conduit
- Nylon inner liner

Code	Size	Finish
H3401501	3000mm	White



T450 Drive Cable

- Helical steel inner drive cable
- Cut to length in 1000mm increments

Code	Size	Finish
H3403001	1000mm	



T800M Conduit Connector

- Plastic covered conduit connector
- For joining two lengths of conduit

Code	Size	Finish
H3402001		White



T700 Spring Stop

- Helical spring stop

Code	Size	Finish
H3404001		



T420 Conduit Plug

- For inserting into end of spent travel conduit

Code	Size	Finish
H3404501		White



T650 Saddle Clips

- Conduit saddle clips
- Required @ 500mm centres & two adjacent on a bend

Code	Size	Finish
H3403501		White



T350 Junction Box

- Rotary junction box
- For connecting satellite drive system to main control

Code	Size	Finish
H3405002	76x40mm	White



T950 Bending Tool

- Conduit bending tool

Code	Size	Finish
H3402501		



T900 Conduit Combination Tool

- Conduit combination tool
- Cuts grooves on to the outside of conduit @ connections

Code	Size	Finish
H3401511		

Electric Window Control

Electrically operated chain window actuators can be activated manually, either by a wall mounted switch or a hand held remote control. Automatic chain window actuators are activated by various sensors which are available to order.



All electric window winding products are suitable for commercial, domestic, educational environments and people with different levels of abilities



Please note:

If the window where the actuator is to be fitted is in a location where running water is present, then a 24VDC actuator should be used with a transformer



ACK4 230 Actuator

- Chain Actuator For Top, Side Or Bottom Hung Sashes
- Max Window Width 1000mm ● Window Opens to 250mm
- 230VAC ● IP55 Rated

Code	Size	Finish
H3405014	289x83x97mm	White



ACK4 24 Actuator

- Chain Actuator For Top, Side Or Bottom Hung Sashes
- Max Window Width 1000mm ● Window Opens to 250mm
- 24VDC ● IP55 Rated

Code	Size	Finish
H3405015	289x83x97mm	White



ACK4 Pin

- Small Adjustment Pin For Gap Between Actuator & Window
- 0-10mm Supplied As Standard With Actuator

Code	Gap
H3405023	10-20mm
H3405024	20-30mm
H3405025	30-40mm



ACK4/SB Bracket

- Standard Window Bracket (Pair)
- For aluminium Windows ● Frame Mounted

Code	Finish
H3405016	White



ACK4/SPB Bracket

- Small Pivot Bracket (Pair)
- For Timber Windows
- Cill Mounted

Code	Finish
H3405017	White



ACK4/LPB

- Large Pivot Bracket (Pair)
- For Upvc Windows ● Frame Mounted

Code	Finish
H3405018	White



ACK4/BHB

- Adaptor Kit (Bracket)
- For Bottom Hung Inward Opening Window

Code	Finish
H3405019	White



S5-1 Rocker Switch

- Single Gang Reactive Rocker Wall Switch
- For Operation Of 230VAC Actuators Or 24VDC Actuators

Code	Finish
H3405012	White



RRT230 Remote Control Unit

- Remote Control Unit For Handheld Operation Of 230VAC Actuators Or 24VDC Actuators ● Built In Radio Receiver To Control Single Or Groups Of Actuators
- 2 Single Channel Remote Controls

Code	Finish
H3405021	White



PS24 Transformer

- Transformer 24VDC Power Supply For H3405015 24VDC Chain Actuator

Code	Finish
H3405022	White

Window Ventilators

A range of window ventilators that assist our clients meeting compliance with Ventilation Regulations in England & Wales within commercial and domestic properties.



All window ventilator products are suitable for commercial, domestic and educational environments



Vent-a-matic Window Ventilators

Vent-A-Matic controllable ventilators are available in various model sizes. Each model is equipped with a diffusing rotor which helps to prevent severe draught and improve fresh air distribution within the room. The rotor also continues to operate whilst under its own inertia, even when air pressure on each side has been equalised.

Controls: Each model is provided with radial shutter control operated by a pull cord



MODEL	APPLICATION
102	Toilets, boats, caravans, sheds
106	Kitchens, bathrooms, bedrooms
SXL	larger rooms, offices, hospitals commercial
C102S	As for 102 but with Stormguard as standard
C106S	As for 106 but with Stormguard as standard

Ventamatic Window Ventilators Model 106

- Rotary Window Vent For Single Glazing up To 6mm thickness
- Cord Operated Shutter
- For 162mm Diameter Aperture

Code	Dia Aperture	Finish
H0746502	162mm	Clear

Ventamatic Window Ventilators Model C106S

- Rotary Window Vent For Single Glazing up To 6mm thickness
- Cord Operated Shutter
- For 162mm Diameter Aperture ● External Stormguard

Code	Dia Aperture	Finish
H0746512	162mm	Clear

Ventamatic Window Ventilators Model 102

- Rotary Window Vent For Single Glazing up To 6mm thickness
- Cord Operated Shutter
- For 121mm Diameter Aperture

Code	Dia Aperture	Finish
H0746501	121mm	Clear

Ventamatic Window Ventilators Model SXL

- Rotary Window Vent For Single Glazing up To 6mm thickness
- Cord Operated Shutter
- For 219mm Diameter Aperture

Code	Dia Aperture	Finish
H0746503	219mm	Clear

Ventamatic Window Ventilators Model 101

- Rotary Window Vent For Single Glazing up To 6mm thickness
- For 121mm Diameter Aperture
- Permanent Airflow

Code	Dia Aperture	Finish
H0746521	121mm	Clear

Ventamatic Window Ventilators Model C102S

- Rotary Window Vent For Single Glazing up To 6mm thickness
- Cord Operated Shutter
- For 121mm Diameter Aperture ● External Stormguard

Code	Dia Aperture	Finish
H0746511	121mm	Clear

Ventamatic Window Ventilators Model 105

- Rotary Window Vent For Single Glazing up To 6mm thickness
- For 162mm Diameter Aperture
- Permanent Airflow

Code	Dia Aperture	Finish
H0746521	162mm	Clear



Framevent/Slot Window/Trickle Vent

Framevent/Slot Window/Trickle Vent is a small opening in a window to allow small amounts of ventilation in spaces intended to be naturally ventilated when the major elements of the window are otherwise closed

- Frame Ventilator ● Integral Flyscreen In External Hood
- 2500mm² Air Space

Code	Size	Finish
H0535616	300mm	White
H0535617	400mm	White

Bathroom Ventilation

Why do you need bathroom ventilation?

To prevent build up of condensation which can lead to mould production, stale smells and poor air quality.

What is air extraction rate & what ventilation shall I get?

The extraction rate is the speed at which a fan can move air. A larger number means a faster rate of extraction. Measured in 'Metres Cubed per Hour' (m3/hr), the air extraction rate of a fan is one of the most important considerations. The Building Regulations stipulate that a bathroom extractor fan must extract at least 54m3/hr in a standard domestic bathroom.

The rate of extraction you require depends on the size of the room and the amount of condensation produced. The bigger the room or if large amounts of condensation are produced, then the more the air will need to be replaced in the room, thus you need a higher rate of extraction.

What is an inline fan?

An inline fan is where the fan motor is remotely sited within the loft space and is connected to the fascia and external wall grill by the supplied flexible ducting.



What is a wall mounted fan?

A wall mounted fan is where the fascia has an integrated fan and the ducting passes through the wall to an external grill.





All window ventilator products are suitable for commercial, domestic and educational environments



Turbo Inline
For Bathrooms, En Suite and Cloakrooms



Inline Fans - Illuminated White

- Bathroom/En Suite/Cloakroom/Wet Room
- MR16 3Watt LED • Size: Ø14.5 x D1.5cm

Turbo Extraction Rate	
Code	Gap
H0746554	137m3/hr Decibels 37dB

Cyclone Extraction Rate	
Code	Gap
H0746550	210m3/hr Decibels 32dB



Inline Fans - Illuminated Chrome

- Bathroom/En Suite/Cloakroom/Wet Room
- MR16 3Watt LED • Size: Ø14.5 x D1.5cm

Turbo Extraction Rate	
Code	Gap
H0746555	137m3/hr Decibels 37dB

Cyclone Extraction Rate	
Code	Gap
H0746551	210m3/hr Decibels 32dB



Cyclone Inline
For Large Bathrooms and Wet Rooms



Inline Fans - White

- Bathroom/En Suite/Cloakroom/Wet Room
- Size: Ø14.5 x D1.5cm

Turbo Extraction Rate	
Code	Gap
H0746556	137m3/hr Decibels 37dB

Cyclone Extraction Rate	
Code	Gap
H0746552	210m3/hr Decibels 32dB



Inline Fans - Chrome

- Bathroom/En Suite/Cloakroom/Wet Room
- Size: Ø14.5 x D1.5cm

Turbo Extraction Rate	
Code	Gap
H0746554	137m3/hr Decibels 37dB

Cyclone Extraction Rate	
Code	Gap
H0746550	210m3/hr Decibels 32dB



Air-Star Illuminated Ceiling Fans

- Flush mounted with built-in low energy LED illumination
- Compatible with Ø10cm ducting
- IPX4 - Electrically safe for use in the bathroom
- MR16 2Watt LED Decibels 33dB • Extraction Rate 89m³/hr

Code	Size	Finish
H0746570	155x155x43mm	White
H0746571	155x155x43mm	Matt Silver



Breeze Wall Mounted Fan

- Slimline, low profile discreet fan • Decibels 33dB
- Compatible with Ø10cm ducting
- Complete with timer
- Extraction Rate 88m³/hr

Code	Size	Finish
H0746558	152x152x33mm	White
H0746560	152x152x33mm	Matt Silver
H0746559	152x152x33mm	Chrome



Breeze Wall Mounted Fan

- Slimline, low profile discreet fan • Decibels 33dB
- Compatible with Ø10cm ducting
- Complete with timer and humidity sensor
- Extraction Rate 88m³/hr

Code	Size	Finish
H0746561	152x152x33mm	White
H0746563	152x152x33mm	Matt Silver
H0746562	152x152x33mm	Chrome



Hush Wall Mounted Fan

- Ultra quiet, low profile plain fan • Complete with timer
- Compatible with Ø10cm ducting
- Extraction Rate 97m³/hr • Decibels 25dB

Code	Size	Finish
H0746564	158x158x30mm	White
H0746566	158x158x30mm	Matt Silver
H0746565	158x158x30mm	Chrome



Hush Wall Mounted Fan

- Ultra quiet, low profile plain fan
- Complete with timer and humidity sensor
- Compatible with Ø10cm ducting
- Extraction Rate 97m³/hr • Decibels 25dB

Code	Size	Finish
H0746567	158x158x30mm	White
H0746569	158x158x30mm	Matt Silver
H0746568	158x158x30mm	Chrome



Accessory Kits

- 3m flexible ducting • external grill & steel hose clamps
- Compatible with Ø10cm ducting

Code	Finish
H0746572	White Grille
H0746573	Brown Grille

Bolts, Stops & Accessories

A full range of quality door and window bolts, coat hooks, door stops and other accessories suitable for commercial and domestic applications. Available in a range of finishes such as polished brass, polished chrome, silver anodised aluminium, stainless steel. The range also includes traditional black japanned and galvanised bolts, hooks and handrail brackets suitable for a variety of applications.



All products with in this section are suitable for commercial, domestic and education environments



Straight Barrel Bolt

Code	Size	Finish
H0480001	50x25mm	Silver Anodised Aluminium
H0480011	75x25mm	Silver Anodised Aluminium
H0480021	100x25mm	Silver Anodised Aluminium
H0480031	150x25mm	Silver Anodised Aluminium
H0480041	150x32mm	Silver Anodised Aluminium
H0480051	200x32mm	Silver Anodised Aluminium



Straight Barrel Bolt

Code	Size	Finish
H0480501	50x25mm	Polished Brass
H0480511	75x25mm	Polished Brass
H0480521	100x25mm	Polished Brass
H0480531	150x25mm	Polished Brass
H0480541	150x32mm	Polished Brass
H0480551	200x32mm	Polished Brass
H0480561	255x38mm	Polished Brass
H0480571	300x38mm	Polished Brass



Straight Barrel Bolt

Code	Size	Finish
H0481501	75x25mm	Polished Chrome
H0481511	100x25mm	Polished Chrome
H0481521	150x25mm	Polished Chrome
H0481531	150x32mm	Polished Chrome
H0481541	200x32mm	Polished Chrome
H0481551	255x38mm	Polished Chrome
H0481561	255x38mm	Polished Chrome
H0480571	300x38mm	Polished Chrome



Necked Barrel Bolt

Code	Size	Finish
H0482001	75x25mm	Silver Anodised Aluminium
H0482011	100x25mm	Silver Anodised Aluminium
H0482021	150x25mm	Silver Anodised Aluminium



Necked Barrel Bolt

Code	Size	Finish
H0482501	75x25mm	Polished Brass
H0482511	100x25mm	Polished Brass
H0482521	150x25mm	Polished Brass



Necked Barrel Bolt

Code	Size	Finish
H0483501	75x25mm	Polished Chrome
H0483511	100x25mm	Polished Chrome
H0483521	150x25mm	Polished Chrome



N&C Lever Action Flush Bolt

Code	Size	Finish
H0642530	152x19mm	Silver Anodised Aluminium
H0642531	203x19mm	Silver Anodised Aluminium
H0488001	150x25mm	Silver Anodised Aluminium
H0488011	200x25mm	Silver Anodised Aluminium



N&C Lever Action Flush Bolt

Code	Size	Finish
H3907002	152x19mm	Polished Brass
H3907102	200x19mm	Polished Brass
H3907202	305x25mm	Polished Brass



N&C Lever Action Flush Bolt

Code	Size	Finish
H0489101	152x19mm	Polished Chrome
H0489102	200x19mm	Polished Chrome
H0489103	305x25mm	Polished Chrome



N&C Lever Action Flush Bolt

Code	Size	Finish
H0489201	152x19mm	Satin Stainless Steel
H0489202	200x19mm	Satin Stainless Steel
H0489202	305x25mm	Satin Stainless Steel
H0489301	152x19mm	Polished Stainless Steel
H0489302	200x19mm	Polished Stainless Steel

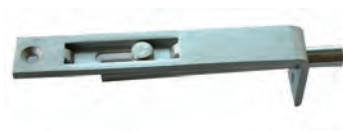

N&C Sunk Slide Flush Bolt

Code	Size	Finish
H0486001	100x15mm	Satin Stainless Steel
H0486011	150x15mm	Satin Stainless Steel



N&C Sunk Slide Flush Bolt

Code	Size	Finish
H0486501	100x15mm	Polished Brass
H0486511	150x15mm	Polished Brass
H0486521	229x25mm	Polished Brass



Easy Clean Socket

- Easy clean socket for concrete floor

Code	Size	Finish
H0485061	13mm	Satin Chrome



Easy Clean Socket

- Easy clean socket for wooden floor

Code	Size	Finish
H0485011	13mm	Satin Anodised Aluminium



Dust Excluding Spring Socket

- Dust excluding spring socket for concrete floor

Code	Size	Finish
H0485551	10mm	Satin Chrome
H0485561	13mm	Satin Chrome

- Dust Excluding Spring Socket For Wooden Floor

Code	Size	Finish
H0485501	10mm	Satin Chrome
H0485511	13mm	Satin Chrome



Straight Tower Bolt

- C/W Staple (Bright Shoots)

Code	Size	Finish
H0491001	100mm	Black Japanned
H0491011	150mm	Black Japanned
H0491021	200mm	Black Japanned
H0491031	255mm	Black Japanned
H0491041	305mm	Black Japanned



Straight Tower Bolt

- C/W Staple

Code	Size	Finish
H0491012	150mm	Bright Zinc Plated
H0491022	200mm	Bright Zinc Plated
H0491042	305mm	Bright Zinc Plated



Necked Tower Bolt

- C/W Plate (Bright Shoots)

Code	Size	Finish
H0491501	150mm	Black Japanned
H0491511	200mm	Black Japanned



Brenton Padlock Bolt

Code	Size	Finish
H0495501	200x16mm	Bright Zinc Plated
H0495511	255x16mm	Bright Zinc Plated
H0495521	305x16mm	Bright Zinc Plated



Bolt Receivers

Tapered side bolt receiver for setting in concrete

Code	Size	Finish
H0494021	28x28mm	Galvanised
Receiver Staple Screw Fix		
H0494031	50x32mm	Galvanised
Receiver Plate Screw Fix		
H0494041	52x52mm	Galvanised
Square Bolt Socket		
H0493501	16mm	Self Colour
Tubular Bolt Socket		
H0494011	16mm	Self Colour

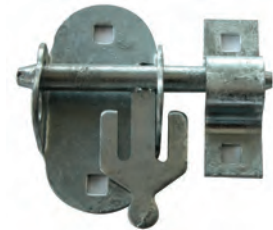

Oval Padlock Bolt

- C/W Staple

Code	Size	Finish
H0496001	115mm	Bright Zinc Plated



N&C Garage Door Drop Bolt

- Surface mounted drop bolt with receiver plate

Code	Size	Finish
H0495001	305x16mm	Galvanised
H0495011	455x16mm	Galvanised
H0495021	610x16mm	Galvanised



N&C Garage Door Foot Bolt

- Surface mounted foot bolt with receiver plate

Code	Size	Finish
H0497001	210mm	Black Japanned
H0497002	210mm	Galvanised



N&C Monkey Tail Bolt

- Surface mounted monkey tail bolt (receivers not included)

Code	Size	Finish
H0494501	380x16mm	Black Japanned
H0494511	455x16mm	Black Japanned
H0494521	610x16mm	Black Japanned
H0494531	760x16mm	Black Japanned
H0494541	915x16mm	Black Japanned



Surface Mounted Indicator Bolt

- Vacant/engaged indicators • External emergency release
- Large turn/lever to bolt • C/W Staple

Code	Size	Bolt	Finish
H0572501	64x38mm	62x41mm	Electro Brass
H0572502	64x38mm	62x41mm	Polished Chrome
H0572503	64x38mm	62x41mm	Satin Chrome

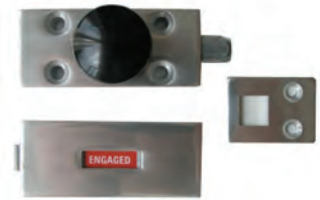

Slide Pattern Surface Mounted Indicator Bolt

- Red/Green Indicators • Rotary internal knob
- C/W Staple

Code	Size	Finish
H0573001	65x28mm	Silver Anodised Aluminium



Facility Indicator Bolt

- For sliding & hinged doors • Red/Green indicators
- External emergency release • Large spatula internal lever
- External pull knob can be fixed in 4 positions
- Touchclean anti bacterial coating!

Code	Size	Finish
H0575503	Universal	Satin Anodised Aluminium



Rubber Door Stop

- Pierced for screw fixing

Code	Size	Finish
H0563001	29mm	Black
H0563002	29mm	White
H0563011	35mm	Black
H0563012	35mm	White
H0563021	50mm	Black



N&C Contractor Wall Door Stop

- Wall mounted buffered door stop

Code	Finish
H0642533	Silver Anodised Aluminium



N&C Contractor Floor Door Stop

- Floor mounted oval door stop for timber floor

Code	Finish
H0642532	Satin Anodised Aluminium



N&C Floor Door Stop

- Oval floor door stop with shield & rubber buffer

Code	Finish
H8001049	Polished Chrome



N&C Projection Door Stop

- Projection door stop on round rose with rubber buffer

Code	Size	Finish
H8001048	75mm	Polished Chrome



N&C Floor Door Stop

- Circular floor door stop with shield & rubber buffer

Code	Size	Finish
H8001063	40x30mm	Polished Chrome



N&C Spring Door Stop

- "Spring" projection door stop with rubber buffer

Code	Size	Finish
H8001069	75mm	Polished Chrome
H8000059	75mm	Polished Brass



N&C Specifier Wall Door Stop

- Concealed fix wall mounted door stop with rubber buffer

Code	Size	Finish
H3711904	75x16mm	Satin Stainless Steel
H3711903	75x16mm	Polished Stainless Steel



N&C Specifier Wall Door Stop

- Concealed fix wall mounted door stop on round rose with rubber buffer

Code	Size	Finish
H3711004	75x16mm	Satin Stainless Steel
H3711003	75x16mm	Polished Stainless Steel



N&C Specifier Floor Door Stop

- Concealed fix floor mounted door stop on round rose with rubber buffer

Code	Size	Finish
H3712104	30mm	Satin Stainless Steel
H3712103	30mm	Polished Stainless Steel



Floor Mounted Door Holder

- Floor mounted door holder ● Not for use with fire door

Code	Size	Finish
H0564501	165x44mm	Polished Brass



Door Mounted Door Holder

- Foot operated sprung plunger ● Not for use with fire door

Code	Size	Finish
H0565001	134x57mm	Electro Brass Plated
H0565002	134x57mm	Satin Chrome Plated



Bayonet Door Holder

- Door mounted bayonet door holder ● Not for use with fire door

Code	Size	Finish
H0565501	89mm	Polished Brass
H0565502	89mm	Satin Chrome Plated



Cabin Hook & Eye

- Strong malleable iron

Code	Size	Finish
H0570001	152mm	Black
H0570011	203mm	Black
H0570021	305mm	Black



Cabin Hook & Eye

- Steel

Code	Size	Finish
H0570511	102mm	Galvanised
H0570521	152mm	Galvanised
H0570531	203mm	Galvanised



Cabin Hook & Eye

- Hot pressed brass

Code	Size	Finish
H0570001	76mm	Polished Brass
H0571011	102mm	Polished Brass
H0571021	152mm	Polished Brass



Cabin Hook & Eye

- Hot pressed brass

Code	Size	Finish
H0571003	76mm	Polished Chrome
H0571013	102mm	Polished Chrome
H0571023	152mm	Polished Chrome





Silent Pattern Cabin Hook & Eye

● Hot pressed brass

Code	Size	Finish
H0571501	76mm	Polished Brass
H0571511	102mm	Polished Brass
H0571521	152mm	Polished Brass
H0571531	203mm	Polished Brass
H0571541	305mm	Polished Brass



Silent Pattern Cabin Hook & Eye

● Hot pressed brass

Code	Size	Finish
H0571503	76mm	Satin Chrome
H0571513	102mm	Satin Chrome
H0571523	152mm	Satin Chrome
H0571533	203mm	Satin Chrome



Hat & Coat Hook

● Screw fix ● Strong extruded aluminium

Code	Size	Finish
H0581001	115mm	Silver Anodised Aluminium



Robe Hook

● Screw Fix ● Strong Extruded Aluminium

Code	Size	Finish
H0581501	38mm	Silver Anodised Aluminium



Hat & Coat Hook

● Screw Fix ● Strong Extruded Aluminium

Code	Size	Finish
H0582001	128mm	Silver Anodised Aluminium



Robe Hook

● Screw Fix ● Strong Extruded Aluminium

Code	Size	Finish
H0582501	43mm	Silver Anodised Aluminium



N&C Contractor Hat & Coat Hook

● Strip Pattern Hat & Coat Hook

Code	Finish
H0580001	Silver Anodised Aluminium



N&C Contractor Robe Hook

● Strip Pattern Robe Hook

Code	Finish
H0580502	Silver Anodised Aluminium



N&C Specifier Hat & Coat Hook

● Strip Pattern Hat & Coat Hook

Code	Finish
H3714004	Satin Stainless Steel



N&C Specifier Hat & Coat Hook

● Strip Pattern Hat & Coat Hook

Code	Finish
H3714003	Polished Stainless Steel



N&C Specifier Robe Hook

● Strip Pattern Buffered Robe Hook

Code	Finish
H3714104	Satin Stainless Steel



N&C Specifier Robe Hook

● Strip Pattern Buffered Robe Hook

Code	Finish
H3714103	Polished Stainless Steel



N&C Hat & Coat Hook

- Traditional Straight Pattern Hat & Coat Hook

Code	Size	Finish
H8070052	125mm	Antique Black



N&C Single Robe Hook

- Traditional Single Robe Hook

Code	Size	Finish
H8070054	55mm	Antique Black



N&C Double Robe Hook

- Traditional Double Robe Hook

Code	Size	Finish
H8070055	55mm	Antique Black



N&C Hat & Coat Hook

- Traditional straight pattern hat & coat hook

Code	Size	Finish
H8000033	125mm	Polished Brass



N&C Single Robe Hook

- Traditional single robe hook

Code	Size	Finish
H8000034	40mm	Polished Brass



N&C Double Robe Hook

- Traditional double robe hook

Code	Size	Finish
H8000099	45mm	Polished Brass



N&C Hat & Coat Hook

- Traditional straight pattern hat & coat hook

Code	Size	Finish
H8001029	125mm	Polished Chrome



N&C Single Robe Hook

- Traditional single robe hook

Code	Size	Finish
H8001030	40mm	Polished Chrome



N&C Double Robe Hook

- Traditional double robe hook

Code	Size	Finish
H8001061	45mm	Polished Chrome



N&C Hat & Coat Hook

- Traditional straight pattern hat & coat hook

Code	Size	Finish
H8002023	125mm	Satin Chrome



N&C Single Robe Hook

- Traditional single robe hook

Code	Size	Finish
H8002024	40mm	Satin Chrome



N&C Double Robe Hook

- Traditional double robe hook

Code	Size	Finish
H8002010	45mm	Satin Chrome



Hat & Coat Hook On Plate

- Screw Fix

Code	Size	Finish
H0583001	88mm	Bronze
H0583002	88mm	Polished Chrome



Wardrobe Hook On Plate

- Screw Fix

Code	Size	Finish
H0583501	51mm	Bronze
H0583502	51mm	Polished Chrome



Child Safety Hook

- Screw Fix • Unbreakable Polycarbonate

Code	Finish
H0585002	Clear



Durahook Hat & Coat Hook

- Screw Fix • Super Tough Nylon



Timber Hat & Coat Rail

- Ash timber 70mm x 32mm thick
- Choice of colours mounted on timber rail

Code	Size	Finish	Code	Size	Hooks
H0585005	93mm	Ocean Blue	H0585050	900mm	6
H0585006	93mm	Black	H0585051	1200mm	8
H0585007	93mm	Baby Blue	H0585052	1500mm	10
H0585008	93mm	Bright Yellow	H0585053	1800mm	12
H0585009	93mm	Fresh Orange	H0585054	2100mm	14
H0585010	93mm	Fresh Green	H0585055	2400mm	16
H0585011	93mm	Deep Red	H0585056	2700mm	18
H0585012	93mm	Claret	H0585057	3000mm	20
H0585013	93mm	Dove Grey			
H0585014	93mm	Spearmint Green			



Multitrack Hat & Coat System

- Single hook unit • 150mm centres

Code	Unit Hooks	Size	Finish
H0587501	Single	50mm	SAA/Black
H0587511	Two	200mm	SAA/Black
H0587521	Three	350mm	SAA/Black
H0587531	Four	500mm	SAA/Black
H0587541	Five	650mm	SAA/Black
H0587551	Six	800mm	SAA/Black
Connector Unit			
H0587561		100mm	SAA/Black



Wire Pattern Hat & Coat Hook

- Screw Fix • Powder coated steel

Code	Size	Finish
H0585001	152mm	White



Aluminium Handrail Bracket

- Aluminium handrail bracket

Code	Size	Finish
H0604511	76mm	SAA



Steel Handrail Bracket

- Strong steel handrail bracket

Code	Size	Finish
H0603511	64mm	Zinc Plated
H0603521	76mm	Zinc Plated
H0605001	51mm	White
H0605011	64mm	White
H0605012	76mm	White



Brass Handrail Bracket

- Brass handrail bracket

Code	Size	Finish
H8000112	65mm	Polished Brass



Heavy Pattern Brass Handrail Bracket

- Heavy pattern brass handrail bracket

Code	Size	Finish
H8000113	64mm	Polished Brass
H8000114	76mm	Polished Brass



Iron Handrail Bracket

- Malleable iron handrail bracket

Code	Size	Finish
H0604011	76mm	Black

Ventilators

A range of straight slotted, louvre and 'hit and miss' ventilators.

Hit and miss ventilators and ventilators with a flyscreen should not be used for venting heat producing appliances i.e. boilers.

Air vent covers available in a range of materials colours and finishes. Suitable for use in bathrooms and kitchens.

Substantial enough to use walls and doors, yet stylish enough to be used in luxury offices, furniture and many other environments

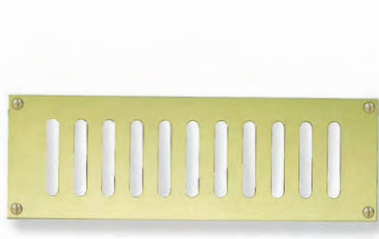

Straight Slotted Ventilator

● Screw Fix

Code	Size	Finish
H8300001	152x76mm	Brass
H8300002	225x76mm	Brass
H8300004	225x225mm	Brass
H8300005	305x76mm	Brass
H8300006	305x150mm	Brass
H8300007	305x305mm	Brass



Straight Slotted Ventilator

● Screw Fix

Code	Size	Finish
H8300101	152x76mm	Silver Anodised Aluminium
H8300104	225x225mm	Silver Anodised Aluminium
H8300105	305x76mm	Silver Anodised Aluminium
H8300106	305x150mm	Silver Anodised Aluminium
H8300107	305x305mm	Silver Anodised Aluminium



Hit & Miss Ventilator

● Screw fix

Code	Size	Finish
H8300401	150x76mm	Brass
H8300402	225x76mm	Brass
H8300403	225x150mm	Brass
H8300501	152x76mm	Silver Anodised Aluminium
H8300502	225x76mm	Silver Anodised Aluminium
H8300503	225x150mm	Silver Anodised Aluminium
H8300504	225x225mm	Silver Anodised Aluminium
H8300505	305x76mm	Silver Anodised Aluminium
H8300507	305x305mm	Silver Anodised Aluminium



Louvre Ventilator

● Screw fix

Code	Size	Finish
H8300201	152x76mm	Brass
H8300202	225x76mm	Brass
H8300203	225x150mm	Brass
H8300304	225x225mm	Silver Anodised Aluminium
H8300305	305x76mm	Silver Anodised Aluminium
H8300306	305x150mm	Silver Anodised Aluminium
H8300307	305x305mm	Silver Anodised Aluminium



Hit & Miss Ventilator Nylon

● Nylon With Flyscreen ● Screw Fix

Code	Size	Finish
H0743501	152x76mm	White
H0743511	229x76mm	White
H0743521	229x152mm	White
H0743531	229x229mm	White



Louvre Ventilator

● Nylon with flyscreen ● Screw fix

Code	Size	Finish
H0744001	229x76mm	White
H0744011	229x152mm	White



Circular Ventilator

● With flyscreen ● Screw fix

Code	Dia	Finish
H0743001	75mm	Bronze
H0743002	75mm	Polished Chrome
H0743012	102mm	Polished Chrome



Access Panel

● High impact polystyrene (Plastic) ● Removeable panel

Code	Dia	Finish
H0746526	150x200mm	White
H0746527	300x300mm	White
H0746530	464x464mm	White

ANTI LIGATURE PRODUCTS

A range of door furniture, window fittings and washroom fittings designed for the less physically abled and the Mental Health Care Markets for use in applications where there is a risk of harm to themselves or others.

Our anti-ligature products are ideal for use in psychiatric wards, hospitals, mental institutions, care homes and prisons. With a large choice of anti-ligature products to choose from, ranging from door handles to pull handles, bathroom turns to hinges you are able to protect all ligature points which might put a person at risk.

We fully recognise that staff safety issues will vary widely between establishments. Our products are manufactured to be fit for purpose, robust and provide members of staff with all the necessary safety features required to address the challenges that can arise. Our products have been tested in accordance with DHF (Door and Hardware Federation) technical specifications for 'door mounted anti ligature devices for safety and security purposes' (TF001).



All products within this section are suitable for commercial use



Anti Ligature Hinge

- Anti ligature double ball bearing butt hinge
- Chamfered tips greatly reduce ligature points

Code	Size	Finish
H0434201	100X75mm	Satin Stainless Steel



Accessible Euro Profile Mortise Sashlock Case

- Suitable for unsprung furniture • Radius forend
- Reversible latchbolt • Cylinder positioned above the lever

Code	Case	Backset	Finish
H0434203	94mm	70mm	Satin Stainless Steel



Accessible Mortise Latch Case

- Suitable For Unsprung Furniture • Radius Forend
- Reversible Latchbolt

Code	Case	Backset	Finish
H0434208	94mm	70mm	Satin Stainless Steel



Accessible Euro Profile Mortise Deadlock Case

- Radius Forend

Code	Case	Backset	Finish
H0434211	94mm	70mm	Satin Stainless Steel



Accessible Mortise Bathroom Lock Case

- Turn positioned above the lever • Radius forend
- Suitable for unsprung furniture • 8mm follower to turn
- Reversible latchbolt

Code	Case	Backset	Finish
H0434214	94mm	70mm	Satin Stainless Steel



Accessible Mortise Emergency Nightlatch Case

- Cylinder positioned above the lever • Radius forend
- Suitable for unsprung furniture • Reversible latchbolt
- Anti thrust function

Code	Case	Backset	Finish
H0434215	94mm	70mm	Satin Stainless Steel



Anti Ligature Clutch Knob

- Suitable for anti ligature lock cases
- Anti ligature clutch knob can be fitted to standard euro profile cylinders or to client's free issue cylinders that may be part of a new or existing master key system
- Converts cylinder to anti barricade solution • Can also be fitted to bathroom turn c/w chamfered edge escutcheons
- Concealed fixings to client side of door

Code	Size	Finish
H0434218	63x10mm	Satin Stainless Steel



Anti Ligature Lever Set

- 50mm round rose • The lever is set at 45 degree angle
- Concealed fixings • Chamfered edges
- When pressure is applied lever falls to 90 degree vertical angle causing the ligature to slip off
- Concealed fixings to client side of door

Code	Size	Finish
H0444903	64x103mm	Satin Stainless Steel



Anti Ligature Lever/Knob Set

- Anti ligature lever handle on round rose with chamfered edge
- Anti ligature door knob with chamfered edge to client side of door • Knob is chamfered to allow maximum grip & ligature resistance • When pressure is applied lever falls to 90 degree vertical angle causing the ligature to slip off
- Concealed fixings to client side of door

Code	Size	Hand	Finish
H0434224	64x103mm		Satin Stainless Steel



Anti Ligature Euro Profile Cylinder Escutcheon

- Chamfered edges ● Back to back fixings

Code	Size	Finish
H0434227	63x10mm	Satin Stainless Steel



Anti Ligature Clutched Bathroom Turn

- Carriage key release prevents barricading
- Chamfered edges ● Concealed fixings to client side of door

Code	Size	Finish
H0434230	63x10mm	Satin Stainless Steel

Spare Carriage Key for Carriage Key Release

Code	Finish
H0434233	Self Colour



Anti Ligature Flush Pull Handle

- Can be fitted vertically or horizontally
- Supplied with face fix tamper proof fittings
- Inside of grip is curved to prevent the insertion of a part to attach a ligature ● Can be fitted vertically or horizontally
- Supplied with face fix tamper proof fittings

Code	Size	Finish
H0434236	150x105mm	Satin Stainless Steel



Anti Ligature Infill Pull Handle On Plate

- Infill prevents ligatures ● Face fix
- Large diameter pull handle provides grip

Code	Size	Finish
H0434239	300x75mm	Satin Stainless Steel



Anti Ligature Pad Pull Handle

- Angled top & bottom to deter the attachment of ligatures
- Bolt through fixed

Code	Size	Finish
H0434242	300x65mm	Satin Stainless Steel



Anti Ligature Norton Pull Handle

- Smooth lines discourage attachment of ligatures whilst Having A "Non Institutional" appearance

Code	Size	Finish
H0434245	250x105mm	Satin Stainless Steel



Anti Ligature Floor Door Stop

- Supplied with tamperproof screw

Code	Finish
H0434248	Satin Stainless Steel

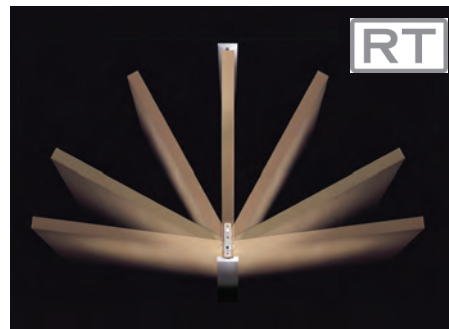

Anti Ligature Pivot Set

- Anti ligature double action door pivot set
- Set comprising: top centre, bottom pivot, & bottom strap
- 80kg max door Weight ● No hinge knuckle ligature point when door is closed

Code	Finish
H0434081	Satin Stainless Steel



Emergency Release Door Stop

- For use with double action door pivot set
- Door can be opened outward & inward
- If door is barricaded to the inside the door can be opened in outward direction

Code	Finish
H0434091	Satin Stainless Steel



N&C Anti Ligature Double Action Door Pivot Set

- Set comprising: top centre, bottom pivot & bottom strap
- 80kg max door weight ● No hinge knuckle ligature point when door is closed

Code	Finish
H0434085	Satin Stainless Steel



N&C Emergency Release Door Stop

- For use with double action door pivot set
- Door can be opened outward & inward
- If door is barricaded to the inside the door can be opened in outward direction

Code	Finish
H0434095	Satin Stainless Steel



Pivot Point Protector

- Pivot point protector protects double action doors from damage caused by them being forced over the door stop
- An economical way of repairing damaged doors & extending the door life

Code	Door Thickness	Finish
H0434251	44mm	Satin Stainless Steel



Anti Ligature Handle to operate Window Espagnolette

- Handle is removable for staff use
- Ideal for top hung fanlights
- Chamfered sides prevent ligature attachment

Code	Finish
H0434257	Satin Stainless Steel



Anti Ligature Cockspur Window Fastener

- Designed to prevent unauthorised opening of windows
- Torx pin key release
- Cockspur can be locked back out of sight when window is open
- Chamfered sides prevent ligature attachment

Code	Finish
H0434260	Aluminium



Anti Ligature Window Pull Handle

- Chamfered sides prevent ligature attachment

Code	Size	Finish
H0434254	150x34mm	Aluminium



Anti Ligature Coat Hook

- Hook is fixed in a ball joint held in place by a sprung ball bearing
- Supplied with tamperproof fixings
- Will carry the weight of a "normal coat" but additional weight will cause it to collapse releasing any ligature
- Can be adjusted for differing weight requirements prior to installation.
- Supplied with tamper proof fixings

Code	Size	Finish
H0434263	63mm	Satin Stainless Steel



Anti Ligature Hinged Support Arm

- The arm can be safely locked down to discourage the attachment of ligatures

Code	Size	Finish
H0434266	750mm	White
H0434269	750mm	Blue



Anti Ligature Vertical Grab Rail

- Infill prevents ligatures
- Face fix
- Large diameter pull handle provides grip

Code	Size	Finish
H0434272	700x100mm	White
H0434275	700x100mm	Blue



Anti Ligature Horizontal Grab Rail

- Large diameter pull handle provides grip
- Infill prevents ligatures
- Face fix
- Infill plate is angled to facilitate drainage of shower water

Code	Size	Finish
H0434278	700x100mm	White
H0434281	700x100mm	Blue



Anti Ligature Wardrobe Rail

- Designed to discourage the attachment of ligatures or standard coat hangers
- Soffit fixed

Code	Size	Finish
H0434284	500mm	White
H0434287	1000mm	White



Anti Ligature Coat Hanger

- For use with anti ligature wardrobe rail
- Designed to fail if excessive weight is exerted & also to discourage the combining of a number of hangers to form a ligature point

Code	Finish
H0434290	White

General Hardware

A selection of miscellaneous products to help solve everyday solutions in both domestic and commercial environments.



Interclamp



Our Interclamp range is made of galvanized cast iron to BS EN ISO 1461 and is a versatile hand railing system typically used as safety guardrails, fencing, playground equipment, sports practice nets, pedestrian barriers and wheelchair access ramps.

The galvanized, malleable, iron slip-on pipe and tube fittings allow fast construction of varied structures made possible by means of a simple, easy to use hexagon key.



Speak to us about our N&C Interclamp DDA Assist range, which is specially designed to aid compliance with the Equality Act.



Handrail Steel Tube

- Plain End Steel Tube 3250mm Length

Code	Size	Finish
Z4019951	48.3mm D	Galvanised
H6700033	42.4mm C	Galvanised



Simple Tee

- Simple Tee 101

Lengths of tube cannot be joined within this fitting

Code	Size	Finish
H6700000	48.3mm D	Galvanised
H6700100	42.4mm C	Galvanised



Straight Connector

- Straight Connector 149

Connector for joining tubes of the same diameter

Code	Size	Finish
H6700001	48.3mm D	Galvanised
H6700101	42.4mm C	Galvanised



Elbow

- Elbow 125

Used where top rail meets end upright on level sites

Code	Size	Finish
H6700002	48.3mm D	Galvanised
H6700102	42.4mm C	Galvanised



Mid Rail Pivot

- Mid Rail Pivot 153

Adjustable from 0 degrees to 11 degrees

Code	Size	Finish
H6700015	48.3mm D	Galvanised
H6700115	42.4mm C	Galvanised



3 Way Elbow

- 3 Way Corner Elbow 128

Used where top rail meets corner on level sites

Code	Size	Finish
H6700003	48.3mm D	Galvanised
H6700103	42.4mm C	Galvanised



Corner - Through Centre Tube

- Corner With Through Centre Tube 116

Lengths of tube cannot be joined within this fitting

Code	Size	Finish
H6700004	48.3mm D	Galvanised
H6700104	42.4mm C	Galvanised



Long Tee

- Long Tee 104

Lengths of tube can be joined within this fitting

Code	Size	Finish
H6700005	48.3mm D	Galvanised
H6700105	42.4mm C	Galvanised



2 Way Cross

- 2 Way Cross 119

Lengths of through tube can be joined

Code	Size	Finish
H6700006	48.3mm D	Galvanised
H6700106	42.4mm C	Galvanised



4 Way Centre Cross

- 4 Way Centre Cross 158

Lengths of tube cannot be joined within this fitting

Code	Size	Finish
H6700007	48.3mm D	Galvanised
H6700107	42.4mm C	Galvanised



Crossover Joint

- Crossover Joint 161

Reduce the need for cutting on horizontal rails

Code	Size	Finish
H6700008	48.3mm D	Galvanised
H6700108	42.4mm C	Galvanised



Wall Plate

- Wall Plate 131

Not recommended as a baseplate

Code	Size	Finish
H6700009	48.3mm D	Galvanised
H6700109	42.4mm C	Galvanised

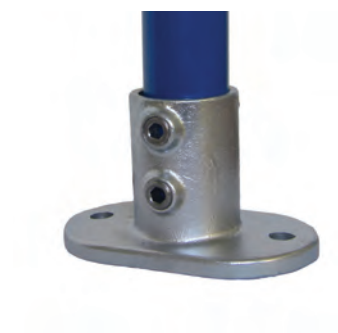

Base Plate

- Base Plate 132

Used for uprights on level site

Code	Size	Finish
H6700010	48.3mm D	Galvanised
H6700110	42.4mm C	Galvanised



Side Support

• Side Support 144
Used to attach guardrail to walls, staircases & ramps

Code	Size	Finish
H6700011	48.3mm D	Galvanised
H6700111	42.4mm C	Galvanised



Slope Base Flange

• Slope Base Flange 152

Code	Size	Finish
H6700012	48.3mm D	Galvanised
H6700112	42.4mm C	Galvanised



Handrail Wall Bracket

• Handrail Wall Bracket 143
Used to attach handrail to walls

Code	Size	Finish
H6700013	48.3mm D	Galvanised
H6700113	42.4mm C	Galvanised



Plastic End Plug

• Plastic End Plug 133
Grey plastic stop end for tube

Code	Size	Finish
H6700014	48.3mm D	Galvanised
H6700114	42.4mm C	Galvanised



Top Rail Pivot

• Top Rail Pivot 154
Adjustable from 0 degrees to 11 degrees

Code	Size	Finish
H6700016	48.3mm D	Galvanised
H6700116	42.4mm C	Galvanised



End Joining Pivot

• End Joining Pivot 155
Adjustable from 0 degrees to 11 degrees

Code	Size	Finish
H6700017	48.3mm D	Galvanised
H6700117	42.4mm C	Galvanised



Pivot - Centre Vertical Through

• Pivot - Centre Vertical Through Tube 156
Lengths of tube cannot be joined

Code	Size	Finish
H6700018	48.3mm D	Galvanised
H6700118	42.4mm C	Galvanised



Single Through Tee Pivot

• Single Through Tee Pivot 173
Adjustable angle, used for awkward applications

Code	Size	Finish
H6700019	48.3mm D	Galvanised
H6700119	42.4mm C	Galvanised



Wall Plate Pivot

• Wall Plate Pivot 169
Used for fixing angled tubes to walls etc

Code	Size	Finish
H6700023	48.3mm D	Galvanised
H6700123	42.4mm C	Galvanised



Double Through Tee Pivot

• Double Through Tee Pivot 167
Adjustable angle, used for awkward applications

Code	Size	Finish
H6700020	48.3mm D	Galvanised
H6700120	42.4mm C	Galvanised



3 Way Elbow Pivot

• 3 Way Elbow Pivot 168
Adjustable angle, used for awkward applications

Code	Size	Finish
H6700021	48.3mm D	Galvanised
H6700121	42.4mm C	Galvanised



Adjustable Elbow Pivot

• Adjustable Elbow Pivot 166
Adjustable angle, used for awkward applications

Code	Size	Finish
H6700022	48.3mm D	Galvanised
H6700122	42.4mm C	Galvanised



Spare Grub/Set Screw

• Spare Grub/Set Screw 300

Code	Size
H6700037	C - D Fittings



Allen Key

• Allen Key

Code	Size
H4019971	C - D Fittings



Elliptical Security Grub Screw

• Requires special allen key to prevent unauthorised removal

Code	Size
H6700038	C-D Fittings



Elliptical Allen Key For Grub Screw

• Allen Key

Code	Size
H6700040	C - D Fittings

Keel Klamp



Keel Klamp components offer a flexible solution for the construction of safety barrier systems and custom systems for railings, roof edge protection and fall prevention. The KEE KLAMP system securely joins standard sizes of structural steel tube into almost any configuration imaginable, utilising the widest range of fittings available on the market today.

Keel Klamp is made of galvanised cast iron to BS EN ISO 1461 and is fitted with KEE KOAT corrosion, protected grub screws and Thread Coat® recess protection

Keel Klamp is TUV certified for strength, manufacturing quality and consistency. Meets specified loadings up to 1500 N/m.



Handrail Steel Tube

● Plain End Steel Tube 3250mm Length

Code	Size		Finish
Z4019951	48.3mm	8	Galvanised
Z4019950	33.7mm	6	Galvanised



Simple Tee

● Simple Tee 10

Lengths of tube cannot be joined within this fitting

Code	Size		Finish
Z4019701	48.3mm	8	Galvanised
Z4019700	33.7mm	6	Galvanised



Straight Connector

● Straight Connector 14

Connector for joining tubes of the same diameter

Code	Size		Finish
Z4019711	48.3mm	8	Galvanised
Z4019710	33.7mm	6	Galvanised



Elbow

● Elbow 15

Used where top rail meets end upright on level sites

Code	Size		Finish
Z4019721	48.3mm	8	Galvanised
Z4019720	33.7mm	6	Galvanised



Mid Rail Pivot

● Mid Rail Pivot 86

Adjustable from 0 degrees to 11 degrees

Code	Size		Finish
Z4019861	48.3mm	8	Galvanised



3 Way Elbow

● 3 Way Corner Elbow 20

Used where top rail meets corner on level sites

Code	Size		Finish
Z4019731	48.3mm	8	Galvanised
Z4019730	33.7mm	6	Galvanised



Corner - Through Centre Tube

● Corner With Through Centre Tube 21

Lengths of tube cannot be joined within this fitting

Code	Size		Finish
Z4019741	48.3mm	8	Galvanised
Z4019740	33.7mm	6	Galvanised



Long Tee

● Long Tee 25

Lengths of tube can be joined within this fitting

Code	Size		Finish
Z4019751	48.3mm	8	Galvanised
Z4019750	33.7mm	6	Galvanised



2 Way Cross

● 2 Way Cross 26

Lengths of through tube can be joined

Code	Size		Finish
Z4019761	48.3mm	8	Galvanised
Z4019760	33.7mm	6	Galvanised



4 Way Centre Cross

● 4 Way Centre Cross 40

Lengths of tube cannot be joined within this fitting

Code	Size		Finish
Z4019781	48.3mm	8	Galvanised
Z4019780	33.7mm	6	Galvanised



Crossover Joint

● Crossover Joint 45

Reduce the need for cutting on horizontal rails

Code	Size		Finish
Z4019791	48.3mm	8	Galvanised
Z4019790	33.7mm	6	Galvanised



Wall Plate

● Wall Plate 61

Not recommended as a baseplate

Code	Size		Finish
Z4019801	48.3mm	8	Galvanised
Z4019800	33.7mm	6	Galvanised



Base Plate

● Base Plate 62

Used for uprights on level site

Code	Size		Finish
Z4019811	48.3mm	8	Galvanised
Z4019810	33.7mm	6	Galvanised



Side Support

• Side Support 64
Used to attach guardrail to walls, staircases & ramps

Code	Size	Finish
Z4019821	48.3mm 8	Galvanised
Z4019820	33.7mm 6	Galvanised



Slope Base Flange

• Slope Base Flange 67

Code	Size	Finish
Z4019831	48.3mm 8	Galvanised
Z4019830	33.7mm 6	Galvanised



Handrail Wall Bracket

• Handrail Wall Bracket 70
Used to attach handrail to walls

Code	Size	Finish
H4019840	48.3mm D	Galvanised
H4019841	33.7mm C	Galvanised



Plastic End Plug

• Plastic End Plug 77
Grey plastic stop end for tube

Code	Size	Finish
Z4019851	48.3mm D	Galvanised
Z4019850	33.7mm C	Galvanised



Top Rail Pivot

• Top Rail Pivot 87
Adjustable from 0 degrees to 11 degrees

Code	Size	Finish
Z4019871	48.3mm 8	Galvanised



End Joining Pivot

• End Joining Pivot 88
Adjustable from 0 degrees to 11 degrees

Code	Size	Finish
Z4019881	48.3mm 8	Galvanised



Pivot - Centre Vertical Through

• Pivot - Centre Vertical Through Tube 89
Lengths of tube cannot be joined

Code	Size	Finish
Z4019891	48.3mm 8	Galvanised



Single Through Tee Pivot

• Single Through Tee Pivot 89
Adjustable angle, used for awkward applications

Code	Size	Finish
Z4019911	48.3mm 8	Galvanised



Double Through Tee Pivot

• Double Through Tee Pivot C51
Adjustable angle, used for awkward applications

Code	Size	Finish
Z4019921	48.3mm 8	Galvanised
Z4019920	33.7mm 6	Galvanised



3 Way Elbow Pivot

• 3 Way Elbow Pivot C52
Adjustable angle, used for awkward applications

Code	Size	Finish
Z4019931	48.3mm 8	Galvanised
Z4019930	33.7mm 6	Galvanised



Wall Plate Pivot

• Wall Plate Pivot C58
Used for fixing angled tubes to walls etc

Code	Size	Finish
Z4019961	48.3mm 8	Galvanised
Z4019960	33.7mm 6	Galvanised



Allen Key 99

Code	Size
Z4019971	8
Z4019970	6



Fencing

A range of fencing for multi purpose usage in domestic and commercial applications. From perimeter fencing and creating barriers for premises/assets/livestock to using as a deterrent and the safeguarding of people, assets and buildings.



Galvanised Chain Link Fencing

- 2.5mm diameter O/A ● 50mm mesh ● 25 Metre roll
- Includes line wires

Code	High	Finish
Z4011501	900mm	Galvanised
Z4011502	1200mm	Galvanised
Z4011504	1800mm	Galvanised



Green PVC Coated Galvanised Chain Link Fencing

- 2.5mm diameter O/A ● 50mm mesh ● 25 Metre roll
- Includes line wires

Code	High	Finish
Z4012001	900mm	Green
Z4012002	1200mm	Green
Z4012004	1800mm	Green



Line Wire For Chain Link Fencing

- Galvanised spare line wires for chain link fencing
- 3.00mm O/D

Code	High	Finish
Z4011510	50 Metres	Galvanised
Z4011521	50 Metres	Galvanised Green



Ratchet Winder

- Galvanised ratchet winder

Code	Finish
Z4012505	Galvanised



Straining Eye Bolts

- BZP Straining eye bolt, nut & washer

Code	Size	Finish
Z4012531	M6x150	Bright Zinc Plated
Z4012534	M8x200	Bright Zinc Plated
Z4102535	M10x250	Bright Zinc Plated
Z4012536	M10x300	Bright Zinc Plated



Barrel Strainer

- BZP barrel strainer

Code	High	Finish
Z4012541	95mm	Bright Zinc Plated
Z4012542	100mm	Bright Zinc Plated
Z4012543	110mm	Bright Zinc Plated



Barbed Wire

- Galvanised barbed wire 4 point

Code	Size	Finish
Z4013502	15 Metres	Galvanised



Galvanised Wire Netting

- 22 Gauge wire ● 13mm mesh

Code	Size	Roll	Finish
Z4008503	600mm	50M	Galvanised
Z4008503	900mm	50M	Galvanised
Z4010002	600mm	25M	Galvanised
Z4010003	1200mm	25M	Galvanised
Z4010004	1800mm	25M	Galvanised



Wire Netting Fasteners

- Galvanised Wire Netting Fasteners
- (Box 200)

Code	High	Finish
Z4012511	16x10mm	Galvanised

Angle Iron Netting Stakes

- Self Colour Angle Iron Netting Stakes
- 40x40x3.0m

For 600mm Fence Height

Code	Size	Finish
Z4012521	1200mm	Self Colour

For 900mm Fence Height

Code	Size	Finish
Z4012522	1500mm	Self Colour

For 1200mm Fence Height

Code	Size	Finish
Z4012523	1800mm	Self Colour

Clothes Airers

Our outdoor airer and accessory range includes a range of robust outdoor airers and accessories to match. This high quality range will help you make the most of your outside space.

We offer a selection of 3 and 4 arm rotary airers perfect for domestic or commercial usage. Line tensioners allow you to adjust the line according to the weight of your clothes, so your laundry does not sag towards the ground whilst drying.



Rotary Clothes Airers

- Domestic galvanised rotary clothes airer
- 3 folding arms • 2.70 metre turning circle
- 2 positional twist grip to adjust line tension
- Complete with ground socket for concrete

Code	Size	Finish
Z4018521	30M	Galvanised
Z4018522	35M	Galvanised

Tubular Soilspear Socket

Code	Dia
Z4018523	32mm



Clothes Line Posts

- Clothes line post • Tubular steel
- With fixed base pegs for concrete fixing

Code	High	Finish
Z4018501	2.44 Metre	Green
Z4018502	2.70 Metre	Green
Z4018503	2.44 Metre	Galvanised
Z4018504	2.70 Metre	Galvanised



Clothes Line Posts

- Clothes line post • Tubular steel
- With loose ground socket

Code	High	Finish
Z4018511	2.44 Metre	Green
Z4018512	2.70 Metre	Green
Z4018513	2.44 Metre	Galvanised
Z4018514	2.70 Metre	Galvanised



Clothes Line Pulleys

- Single screw pulley • Nylon wheel

Code	Size	Finish
H0616501	44mm	Epoxy Black



Single Wheel Upright Pulley

- Single wheel upright pulley • Nylon wheel

Code	Size	Finish
H0617011	44mm	Epoxy Black



Single Wheel Line Pulley

- Single wheel line pulley • Nylon wheel

Code	Size	Finish
H0617501	32mm	Galvanised
H0617501	38mm	Galvanised



Commercial Rotary Clothes Airers

- Commercial galvanised rotary clothes airer
- 4 non folding arms • 3.30 metre turning circle
- Heavy duty for permanent installation

Code	Size	Finish
Z4018601	30M	Galvanised
Z4018602	35M	Galvanised



Commercial Rotary Clothes Airers Hoist

- Commercial galvanised rotary clothes airer hoist
- 4 non folding arms with rotary handle
- 3.30 metre turning circle
- Heavy duty for permanent installation

Code	Size	Finish
Z4018602	35M	Galvanised

Ground Socket

Code	Finish
Z4018603	Galvanised

Spare Line

Code
Z4018604

Gutter Protection

Solutions for the protection of gutter systems against the natural forces of nature, such as snow, leaves and other destructive forces.

Our snow guards are designed to prevent mass quantities of snow and ice from avalanching off roofs, causing extensive damage to the gutter system, property and pedestrians below.

Our range of 'Hedgehog' products prevent the build up of leaves and other debris to help prevent clutter.



Snowguard

- 2 metre lengths
- Retains fallen snow on pitched roofs

Code	High	Finish
Z4008001	152mm	Galvanised
Z4008002	229mm	Galvanised

Snowguard Bracket

- For half round gutter

Code	High	Finish
Z4008003	152mm	Galvanised
Z4008004	229mm	Galvanised

Snowguard Bracket For Ogee Gutter

- Suits both 152mm & 229mm high snowguard

Code	Finish
Z4008005	Galvanised



It is recommended to use at least 4 brackets per 2 metre length of snowguard



Hedgehog products solve blocked gutter and drain problems immediately.

- Fitted in minutes and lasts for years
- Easy to fit and does not require special installation expertise
- Fits most types of gutters
- No more overflowing gutters and drains
- Avoids ladder climbing for maintenance
- Also fits traditional iron and asbestos gutters
- Adapts automatically to the shape of any gutter
- Avoids the need to call in costly professionals to unblock gutters
- Fits around corners and over down pipe outlets



Hedgehog

- "Hedgehog" Gutterbrush Protector
- Prevents build up of leaves/debris etc in gutters

Code	High	Finish
Z4008031	4 Metre	Black
Z4008032	4 Metre	White

Hedgehog Fixings

- Fixings For "Hedgehog" Gutterbrush Protector
- Pack of 20

Code	Finish
Z4008033	Clear



Gutterscoop Gutter Cleaner

- For cleaning gutters prior to installing hedgehog

Code	Finish
Z4008033	Clear

Protection

A range of protective solutions that the protection of people and assets through intruder spikes, as well as deterrents for pests such as insects and pigeons.



Anti Intruder Spikes

- "Prikka-strip" anti intruder spikes
- Suitable for tops of fences, gates, pipes, walls & sills
- Strong polypropylene construction with 15mm sharp spikes
- Silicone Adhesive Or Screw Fixed
- 500mm lengths easily cut/formed on site
- Warning notice included in pack

Code	Pack	Finish
H0123001	4 Metre	Grey

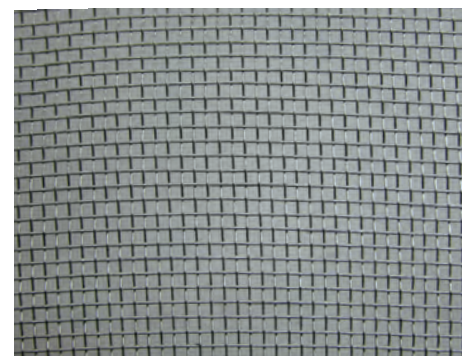
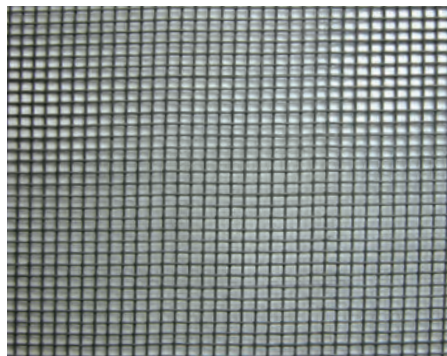
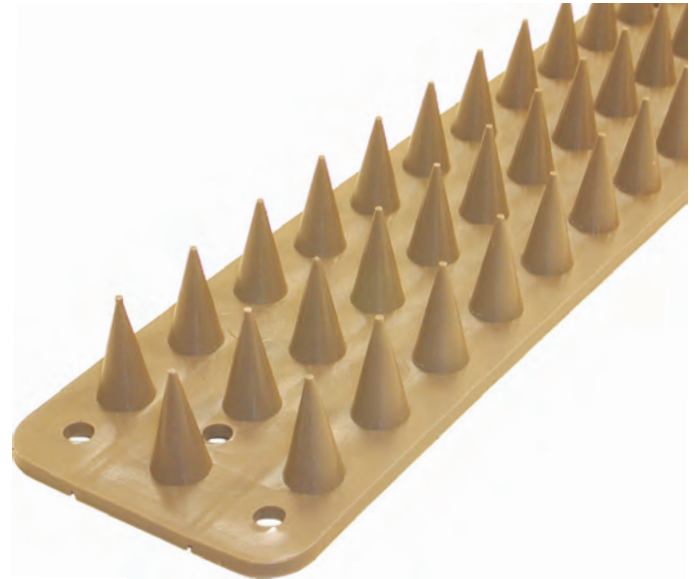

Pigeon Spikes

- "birdban" anti perching pigeon spikes
- Suitable for perching/roosting sites
- Strong uv stabilised clear polycarbonate
- Silicone adhesive or screw fixed
- 327mm lengths easily cut on site

Code	Pack Size	Finish
H0619001	2 Metre	Clear
H0619002	6 Metre	Clear
H0619003	20 Metre	Clear
H0619005	100 Metre	Clear

Insect Screening Fibreglass Flymesh

- PVC Coated fibreglass
- Mesh count 16x18 per inch
- Will not sag or ripple in use
- 1200mm wide
- Cut to size in 1000mm increments

Code	Finish
Z9000018	Grey

Insect Screening Aluminium Flymesh

- Acrylic coated aluminium
- Mesh count 16x18 Per Inch
- Use where steam cleaning may be required
- 610mm wide
- Cut to size in 1000mm increments

Code	Finish
Z9000015	Bright



N&C Fingershield

- Heavy duty flexible finger protection

Code	Size	Finish
H0855744	Hinge knuckle side of door	1960mm White
H0855745	Both sides of door	1960mm White

Bicycle and Scooter Racks

The easiest and most cost effective solution for parking bicycles is through the provision of cycle holders and or cycle stands.

Our bike holders and stands come in a wide range of configurations. Select from wall mounted or those that are fixed to the surface (flanged). We also have multi-rack individual cycle rack holders which can be purchased as single units but then can be built up as required to form larger rack units. This option allows you to scale your cycle parking solution to your own specific requirements and grow if demand for cycle parking increases.

All of our cycle holders and stands are manufactured from tough, durable galvanised steel and are therefore built to last.



Sheffield Style Bicycle Stand

- Flanged ends for bolting to a solid floor
- 6 fixing bolts per stand required (not Included)

Code	High	Wide	Finish
Z4019507	750mm	800mm	Galvanised



Floor Mounted Scooter Rack

- Floor mounted galvanised scooter rack
- Hoops welded to crossbar allows scooter to be secured with a cycle lock
- Flanged end for bolting to a solid floor
- 6 fixing bolts per stand required-not included

Single Sided-Holds 4 Scooters

Code	High	Wide	Finish
Z4019580	770mm	880mm	Galvanised

Double Sided-Holds 8 Scooters (4 Each Side)

Code	High	Wide	Finish
Z4019582	770mm	880mm	Galvanised

Double Sided-Holds 10 Scooters (5 Each Side)

Code	High	Wide	Finish
Z4019584	770mm	880mm	Galvanised

Double Sided-Holds 20 Scooters (10 Each Side)

Code	High	Wide	Finish
Z4019586	770mm	880mm	Galvanised

Cable Lock Supplied With 2 Keys

Code	Size	Finish
H0184831	1800mm	Black



Floor Mounted Bicycle Holder

- Floor Mounted Galvanised Individual Bicycle Holder
- Flanged End For Bolting To A Solid Floor
- 3 Fixing Bolts Required-Not Included

Code	High	Finish
Z4019506	687mm	Galvanised



Wall Mounted R45 Bicycle Holder

- Wall mounted galvanised individual bicycle holder
- Bicycle held at 45 degree angle from wall
- Suitable for bolting to wall, post or rail
- Centre of holder recommended fixed at 345mm from floor level
- 2 fixing bolts required-not included

Code	High	Finish
Z4019505	296mm	Galvanised



Wall Mounted R90 Bicycle Holder

- Wall mounted galvanised individual bicycle holder
- Bicycle held at 90 degree angle from wall
- Suitable for bolting to wall, post or rail
- Recommended fixed at 345mm
- 2 fixing bolts required-not included

Code	High	Finish
Z4019504	296mm	Galvanised



Hinged Parking Post

- Floor Mounted Galvanised Individual Bicycle Holder
- Lockable In The Up & Down Positions • 2 Keys
- Integral Lock Randomly Keyed • Black Weather Cap
- 2 Fixing Bolts Required-Not Included

Code	High	Dia	Finish
Z4019511	743mm	64mm	Galvanised



Hinged Toplok Parking Post

- Hinged Galvanised Lockable Parking Post
- Lockable In The Up & Down Positions
- Lockable By Padlock-Not Included
- Black Weather Cap • 2 Fixing Bolts Required-Not Included

Code	High	Dia	Finish
Z4019512	743mm	64mm	Galvanised



Stealth Parking Post

- Hinged Galvanised Lockable Parking Post
- Lies Flat In Integral Ground Socket In Down Position
- Lockable In The Up & Down Positions
- Integral Lock Randomly Keyed • 2 Keys
- Black Weather Cap • 2 Fixing Bolts Required-Not Included
- Ground Socket 865x220x95mm

Code	High	Dia	Finish
Z4019512	743mm	64mm	Galvanised



Flanged Boundary Post

- Floor Mounted Galvanised Fixed Boundary Post
- Flanged End For Bolting To A Solid Floor
- Black Weather Cap • 3 Fixing Bolts Required-Not Included

Code	High	Dia	Finish
Z4019511	743mm	64mm	Galvanised



Ragged Boundary Post

- Floor Mounted Galvanised Fixed Boundary Post
- Ragged End For Casting Into A Solid Floor
- Black Weather Cap

Code	High	Dia	Finish
Z4019514	750mm	43mm	Galvanised



Security Mirrors

- Polycarbonate Circular Security Mirror
- Post Or Wall Fixing

Code		Dia	Finish
Z4019421	Circular	620mm	Mirror
Z4019422	Circular	450mm	Mirror
Z4019431	Rectangular	600x450mm	Mirror

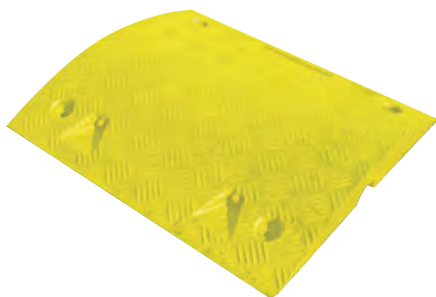

Rubber Speed Ramps

- Rubber speed ramp system • 50mm high
- cats eyes fitted as standard • sold in pairs
- each pair has one yellow & one black section
- each pair supplied with sufficient fixings
- quickly installed & re-locatable • centre sections

Code	Size	Wide	Finish
Z4019411	500mm	470mm	Black/Yellow



Rubber Speed Ramps End Sections

- 2 end sections can also make a circular speed bump

Code	Size	Wide	Finish
Z4019401	200mm	470mm	Black/Yellow



N&C Steel Tee Hinges Medium Weight

- Medium Weight Steel Tee Hinges

Code	Size	Finish
H0460001	230mm	Japanned
H0460011	300mm	Japanned
H0460021	375mm	Japanned
H0460031	450mm	Japanned



N&C Steel Tee Hinges Heavy Weight

- Heavy Weight Steel Tee Hinges

Code	Size	Finish
H0460551	300mm	Galvanised
H0460561	450mm	Galvanised
H0460571	600mm	Galvanised



N&C Steel Strap Hinges

- Straight Steel Strap Hinges - (Closed Sizes Shown)

Code	Size	Finish
H0461001	152mm	Self Colour Steel
H0461011	203mm	Self Colour Steel
H0461021	305mm	Self Colour Steel



N&C Steel Reversible Hinges

- Light pattern steel reversible hinges

Code	Size	Finish
H0461501	254mm	Self Colour Steel
H0461511	305mm	Self Colour Steel
H0461521	406mm	Self Colour Steel
H0461531	457mm	Self Colour Steel
H0461541	610mm	Self Colour Steel



N&C Steel Reversible Hinges

- Heavy pattern steel reversible hinges

Code	Size	Finish
H0462001	457mm	Self Colour Steel
H0462011	610mm	Self Colour Steel
H0462021	760mm	Self Colour Steel
H0462031	914mm	Self Colour Steel



N&C Hook & Ride Hinges

- Wrought iron hook & ride hinges
- Hook on screw fix plates

Code	Size	Finish
H0462001	305mm	Self Colour Steel
H0463011	405mm	Self Colour Steel
H0463021	457mm	Self Colour Steel
H0463031	610mm	Self Colour Steel



N&C Double Strap Field Gate Hinges

- Heavy pattern steel with long top band
- To bolt & short bottom band to drive
- Suits 75mm thickness timber gate

Code	Size	Finish
H0465001	610mm	Self Colour Steel

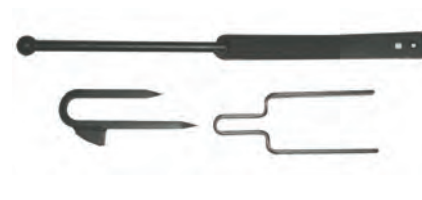

N&C Field Gate Latch

- Spring field gate latch set with catch & keep

Code	Size	Finish
H0465501	610mm	Self Colour Steel



N&C Coil Gate Spring

- Coil gate spring

Code	Size	Finish
H0436061	255mm	Black Japanned



N&C Gate Catch

- Balance Gate Catch With Lugs For Stone

Code	Size	Finish
H0498001	305mm	Galvanised

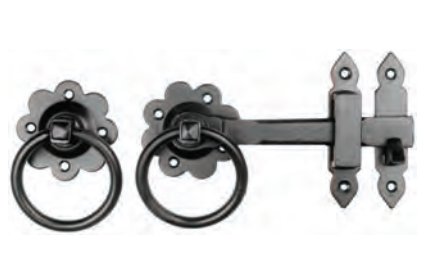

N&C Gate Latch

- Gate Latch With Ring Handles

Code	Size	Finish
H0786001	178mm	Black Iron
H0786002	178mm	Zinc Plated



N&C Suffolk Latch

- Suffolk Latch

Code	Size	Finish
H0436061	255mm	Black Japanned
H0786521	216mm	Black Japanned
H0786522	216mm	Galvanised

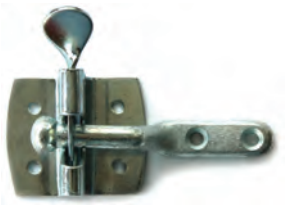

N&C Automatic Gate Catch

- Automatic Gate Catch With Peg

Code	Size	Finish
H0787501	51x51mm	Galvanised
H0787511	60x57mm	Galvanised



N&C Gate Closer

- Heavy Duty Gate Closer For Timber & Metal Gates
- Two Speed Closing With 90 Degree ● Hold Open Facility

Code	Size	Finish
Z4020558	300mm	Black



N&C Garage Door

- Overhead Garage Door Holder With Cord Release
- Screws, Bolts

Code	Size	Finish
H0497501	381mm (Wide Lintels)	Black
H0497511	610mm (Narrow Lintels)	Black
H0497521	610mm (Single narrow Lintels)	Black



N&C Garage Door Drop Bolt

- Garage Door Surface Mounted Drop
- Bolt With Receiver Plate ● Galvanised Shoot Bolt

Code	Size	Finish
H0495001	305x16mm	Black
H0495011	610x16mm	Black



N&C Garage Door Foot Bolt

- Garage Door Surface Mounted Foot
- Bolt With Receiver Plate ● Galvanised Shoot Bolt

Code	Size	Finish
H0497001	210mm	Black
H0497002	210mm	Galvanised



N&C Monkey Tail Bolt

- Surface Mounted Monkey Tail Bolt
- Galvanised Shoot Bolt

Code	Size	Finish
H0494501	380x16mm	Black
H0494511	455x16mm	Black
H0494521	610x16mm	Black
H0494531	760x16mm	Black
H0494541	915x16mm	Black



N&C Bolt Receivers

- Tapered Side Bolt Receiver For Setting In Concrete

Code	Size	Finish
H0494550	28x28mm	Galvanised Cast Iron



N&C Bolt Receivers

- Receiver Staple Screw Fix

Code	Size	Finish
H494551	50x32mm	Galvanised



N&C Bolt Receivers

- Receiver Plate Screw Fix

Code	Size	Finish
H0494552	52x32mm	Galvanised



All products with in this section are suitable for commercial and domestic environments

INDEX

A		D		I		R	
Access Panels	146	Dead Locks	44,47,52,58	Indicator Bolts	8,10-12,14,16-21,26,27,31,141	Radar Cover Plates	54
Accessible Mortice Bathroom Lock	148	Digital Locks	55	Industrial Sliding Door Gear	111,112	Radar Hasp & Staple	54
Accessible Mortice Deadlock	148	Din Standard Locks & Latches	52	Insect Screening	159	Radar Keys	54
Accessible Mortice Emergency Nightlatch	148	Door Bells	37	Interclamp Railing System	152,153	Radar Locks	54
Accessible Mortice Latch	148	Door Bolts	57	Internal Door Sliding Door Gear	106-110	Radar Padlock	54
Accessible Mortice Sashlock	148	Door Chains	37	Intumescent Fire Blocks & Grilles	80	Rebate Conversion Sets	47
Acorn Sash Stop	130	Door Closers	70-77	Intumescent Foam	81	Redlam Bolt	85
Adjustable Twin Slot Shelving	122	Door Controls	71,73	Intumescent Glazing Tape	81	Reversible Hinges	64,162
Anti Intruder Spikes	159	Dorgards	71	Intumescent Hinge Pads	81	Rim Cylinders	49,51
Anti Ligature Clutch Knob	148	Door Guards	37	Intumescent Letter Plates	81	Rim Deadlock	53
Anti Ligature Clutched Bathroom Turn	149	Door Holders	27,71,73,142	Intumescent Mastic	81	Rim Latch	49
Anti Ligature Coat Hanger	150	Door Knockers	36	Intumescent Paper	81	Rim Lock	49
Anti Ligature Coat Hook	150	Door Numbers	35	Intumescent seals	80	Rim Nightlatches	49,50,51
Anti Ligature Cockspur Handle	150	Door Letter	35			Rising Butt Hinges	61
Anti Ligature Cylinder Escutcheon	149	Door Packs	32,33	K		Roller Arm Stays	131
Anti Ligature Espagnolette Handle	150	Door Pivots	149	Keel Klamp Rail System	154,155	Roller Catches	58,116
Anti Ligature Floor Door Stop	149	Door Stops	9,12,15,27,141,142	Kicking Plates	9-11,15	Rotary Clothes Airers	157
Anti Ligature Flush Pull Handle	149	Door Thresholds & Seals	40	Knob Furniture	26,29		
Anti Ligature Grab Rail	150	Door Viewers	36,37			S	
Anti Ligature Hinge	148	Dorguard	71			Sash Chain & Fittings	129
Anti Ligature Hinged Support Arm	150	Dormer Door Controls	74-77	L		Sash Chains	129
Anti Ligature Lever Set	148	Draught Excluders	40	Latch Furniture	32,33	Sash Cord	129
Anti Ligature Norton Pull Handle	149	Drawer Locks	114,115	Letter Plates	15,34,38	Sash Fasteners	130
Anti Ligature Pivot Set	149	Durahooks	145	Letter Tidy	34	Sash Fasteners	130
Anti Ligature Wardrobe Rail	150			Lever Furniture On Plate	7,13,23,24,28-33,38	Sash Handles	130
Anti Ligature Window Handle	150	E		Lever Furniture On Rose	7,10,11,13,16-24,28,29	Sash Lifts	130
Anti Ligature Lever/Knob Set	148	Easyclean Hinges	66	Line Posts	157	Sash Lock Cases	52
Anti Pigeon Spikes	159	Electrically Operated Window Openers	134	Line Pullies	157	Sash Locks	44-47,52,58
Axle Pullies	128	Emergency Release Door Stop	149	Lockable Fateners	128	Sash Screw	130
		Endless Cords	131	Locking Bars	56	Sash Stops	130
B		Escape Locks	85	London Bar	57	Sash Weights	129
Back Flap Hinges	62	Escape Route Signs	88-91	Long Lipped Strikeplates	51	Scooter Racks	160
Bales Catch	116	Escutcheons	8,10,11,14,16-21	Loose Pin Hinges	61	Secondary Security Fittings	57
Ball Bearing Hinges	60,61	Euro Profile Cylinders	48			Security Bolts	57
Ball Catch	116	Euro Profile Locks	44,45,47,52	M		Security Mirrors	161
Banjo Shelf Supports	123	Extractor Fans	136,137	Magnetic Catches	116	Shelf Brackets	122,123
Barrel Bolts	12,26,31			Manually Operated Window Winding Gear	132,133	Shelf Strips & Fittings	123
Bathroom Extractor Fans	136,137	F		Meakins Sash Openers	130	Shelf Systems	123
Bathroom Indicator Bolts	8,10-12,14,16,21,26,27,31	Facility Indicator Bolt	141	Mechanical Digital Locks	55	Site Instruction Signs	97-101
Bathroom Locks	32,33,58	Fanlight Catch	131	Monkey Tail Bolts	163	Sliding Door Gear	106-112
Becode Keyless Locks	117	Fencing & Fittings	156	Mortice Bathroom Locks	32,33,45,47,52,58	Sliding Door Locks	106
Bell Push	37	Field Gate Hinge	64,162	Mortice Deadlocks	44-47,58	Sliding Door Track	106
Bicycle Racks	160	Field Gate Latch	162	Mortice Latches	32,33,58	Smoke Alarm	82
Bifold Door Gear	110	Finger Shield	159	Mortice Nightlatches	52	Snowguard	158
Bird Ban	159	Finger Plates	9,10,11,15	Mortice Sashlocks	32,33,44-47,52,58	Soss Hinges	63,121
Birmingham Bar	57	Finger Pull	120	Multipoint Locks	39	Speed Ramps	161
Black Antique Door Furniture	30	Fire Action Signs	93			Spiral Sash Balances	131
Black Antique Window Fittings	126,127	Fire Blanket	82	N		Spring Hinges	65
Bolt Sockets	163	Fire Brigade Keys	53	N&C Cupboard Locks	114	Squash Court Handle	120
Bookcase Strip	123	Fire Brigade Locks	53	N&C Door Selector	71	Steel Reversible Hinges	64,162
Brass Door Hinges	61,62	Fire Brigade Padlocks	53	N&C Electro Magnetic Door Closers	70	Stormproof Hinges	66
Break Glass Key Boxes	82	Fire Door Signs	94	N&C Electro Magnetic Floor Spring	71	Strap Hinges	64,162
Break Glass Mortice Locks	85	Fire Escape Locks	85	N&C Fire Exit Hardware	83		
Brenton Bolt	140	Fire Extinguisher Signs	92	N&C Floor Springs	70,71	T	
British Standard Locks	45,46	Fire Extinguishers	82	N&C Jamb Mounted Door Closer	70	Tactile & Braille Nameplates	104
Briton Door Controls	72,73	Floor Springs	70,71,76,77	N&C Overhead Door Closers	70	Tactile & Braille Pictograms	102-103
Briton Fire Exit Hardware	84	Flush Bolts	139	N&C Transom Mounted Door Closers	70	Tactile & Braille Pushplates	104
Budget Door Furniture	32,33	Flush Cabinet Handles	120	Nameplates	96	Tee Hinges	64,162
Budget Locks	115	Flush Hinges	62	Narrow Stile Nightlatches	51	Thresholds	40
Butt Hinges	60,61	Flymesh	159	Numerals	35	Transom Mounted Door Controls	70,76
		Friction Hinges	66	O		Tubular Latches	32,33,58
C				Oval Profile Cylinders	48	Touch Latch	116
Cabin Hooks	12,26,142,143	G		Oval Profile Mortice Lockcases	44,45,47,52,	Tower Bolts	140
Cabinet Handles	118,119	Garage Door Bolts	140,163			U	
Cabinet Hinges	120,121	Garage Door Holder	140,163	P		Union Strongbolt Locks	46,47
Cabinet Knobs	118,119	Gate Catches	162,163	Padbolts	140	Upvc Door Furniture	38
Cabinet Locks	106,114,115,117	Gate Closer	163	Padlock Bars	56		
Cabinet Sliding Door Gear	106	Gate Fittings	162,163	Padlocks	56	V	
Cam Locks	117	Gate Spring	162	Panic Bolts & Latches	83,84	Vent-A-Matics	135
Carbon Monoxide Alarm	82	Gutter Protection	158	Parking Posts	161	Ventilators Bathroom	135
Card Frames	119	Gutter Scoop	158	Parliament Hinges	62	Ventilators Hit & Miss	146
Casement Fasteners	127,128			Patlock	39	Ventilators Louvre	146
Casement Stays	126,127	H		Perko Door Closer	78	Ventilators Trickle	135
Cellar Flap Hinge	64	Handrail Brackets	145	Perkomatic Door Closers	78	Vertical Locking Bar	56
Centre Door Knobs	36	Hanging Rail & Fittings	121	Pictograms	95,102,103		
Chain Link Fencing	156	Hasp & Staples	56	Pin Tumbler Cylinders	48	W	
Clothes Airers	157	Hat & Coat Hooks	9,15,31,143-145	Pivot Point Protector	149	Wardrobe Rail & Fittings	121
Clothes Line Posts	157	Hazard Signs	100,101	Pocket Door System	109	Wardrobe Sliding Door Gear	107-110
Concealed Hinges	63	Hedgehog Gutter Protection	158	Pole Hooks	131	WC Cubicle Fittings	124
Continuous Hinge	63	Hi-Load Hinges	60	Postal Knockers	36	Window Fittings	38,126-128
Counterflap Catch	63	Hinge Bolts	57	Powermatic Door Closers	78	Window Hinges	66
Counterflap Hinge	63	Hinges	32,33,60-66,162	Prohibition Signs	97-99	Window Pivots	131
Cupboard Knobs	9,118,119	Hush Latch	116	Projection Hinges	62	Window Restrictors	128
Cupboard Locks	114,115,117	Hook & Ride Hinges	64	Pull Handles	8,10,11,14,16,25	Window Winding Gear	132-134
Cubicle Fittings	124	Horizontal Locking Bar	56			Wire Netting	156
Cylinder Pull	9,15,37			Q		Wrought Iron Hook & Ride Hinges	64,162
Cylinder Rim Nightlatches	49-51			Quadrant Stays	131		
Cylinders	48,49					Y	
						Yale Cylinder Rim Nightlatches	50,51

Total Solution *provider*



WETROOMS

As manufacturers of the complete system, N&C offer every component required to create a stylish, level access showering environment.



BATHS

From contemporary and classic, we have a broad collection of baths in a range of shapes and styles perfect for hotels.



WALL & FLOOR TILES

N&C are leading suppliers of award winning ceramic, porcelain and natural stone wall and floor tiles.

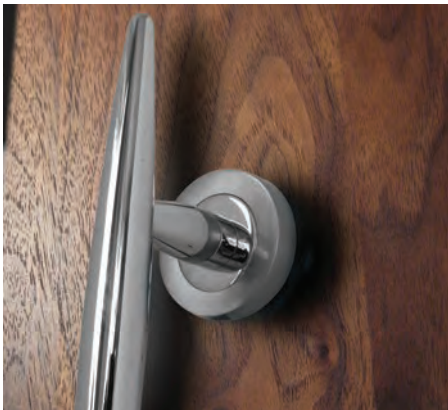

IRONMONGERY

As ironmongers since 1875, and as part of the Guild of Architectural Ironmongers, we specialise in everything for a commercial & domestic environment



FLOORING

As leading manufacturers, we provide quality materials for required safety flooring, such as althro, vinyl tiles and screeds.



ADHESIVES

We manufacture innovative, high performance adhesives, grouts and tiling systems through our Nicobond brand, within our UK based factory.



INDEPENDENT LIVING

Through our Phlexicare brand, N&C are leading manufacturers and distributors of independent living solutions designed for people with all levels of abilities, covering accessible showering, multi user kitchens and more.



DECORATING

Our builders merchant division offers all the popular trade brands for decorators and building professionals.



GLASS & GLAZING

As the UK's leading independent supplier of commercial and domestic glass and glazing products, we can offer unrivalled solutions at competitive prices.



N&C Building Products Ltd.
Registration Number: 140
Registered in England
www.nichollsandclarke.com

Nicholls & Clarke

— Est 1875 —

N&C Building Materials
41 - 51 Freshwater Road, Chadwell Heath
Romford, Essex RM8 1SP
Tel: 020 8586 4600
Fax: 020 8586 4646
www.nichollsandclarke.com

 Follow us:
[NCGroupLtd](https://twitter.com/NCGroupLtd)

 Find us:
[Nicholls and Clarke Group of Companies](https://www.facebook.com/NichollsandClarkeGroupofCompanies)

 Subscribe to us:
[Nichollsandclarke](https://www.youtube.com/NichollsandClarke)