

Tiling Essentials *for the Trade*

Performance products for tiling professionals

edition 2

sigma
Series 3 Max
3D4M 92cm Tile Cutter

FROM
£328
each



ONLY
£129.99
each

Warmup
6IE Wi-fi Thermostat

Lowest Prices Largest Stocks Fastest Deliveries

Tile Cutting & Drilling 4 - 33

Large Format Tile Cutting & Lifting 34 - 43

Tiling Tools & Consumables 44 - 71

Tiling Solutions 72 - 81

Tile Adhesives & Grouts 82 - 91

Tile Trims and Profiles 92 - 165

Wet Rooms 166 - 171

Flooring Screeds & Tools 172 - 183

Vinyl Flooring 184 - 187

Undertile Heating 188 - 215

PPE and Workwear 216 - 219

Power Tools 220 - 225

24/7 Online Ordering 

Free Delivery 
Account Customers*

Top Trade Brands 

Nationwide Delivery 

PROFESSIONAL
Nicobond



**British
Manufacturers**



**Top Trade
Brands**



**Inventors &
Innovators**



**24/7 Online
Ordering**



**Trade
Rates**



**Nationwide
Delivery***



**Huge
Stocks**



**Technical
Support**

Your Trade Website 24/7 Online Ordering

Access your trade prices
Place orders quickly
with buying lists and manage your invoices



We are heavily involved in The Tile Association, the voice of the UK tile industry to ensure products and systems are of the highest quality and meet the stringent requirements set out by European and British Standards.





Low Prices
for the
TRADE

WE HOLD HUGE STOCKS OF EVERYDAY TRADE ESSENTIALS

At N&C, we have huge stocks equating to approximately 60,000 products to help you complete the job!

IN STOCK
take away
today!

We stock top trade brands at competitive prices!



All prices exclude VAT and are subject to our terms and conditions, please see our website. All prices correct at time of going to print and we reserve the right to amend any price shown. Price will be deemed correct at time of despatch. All prices correct at time of going to print and we reserve the right to amend any price shown. Price will be deemed correct at time of despatch

Tile Cutting & Drilling

for the Trade



Only
£60
Bundle Price

Rubi 115mm Diamond Cutting & Grinding Bundle

N4900040 Rubi Turbo Viper
Diamond Blade TVA115 Plus
N4900027 Rubi ECD115 2 In 1
Cutting / Grinding Blade



Montolit Masterpiuma 3 Manual Cutter

A super-professional manual tile cutter that can cut all types of tiles, with thickness of 0-22 mm quickly and accurately. Thanks to the large protractor square, even diagonal cutting is safe and simple.

- Engineered for easy cutting all types of available ceramics, porcelain and glass tiles, including glass mosaic
- Accurate and extremely powerful ergonomic push scribe handle.
- Recognized as the most effective lever on the tile cutter

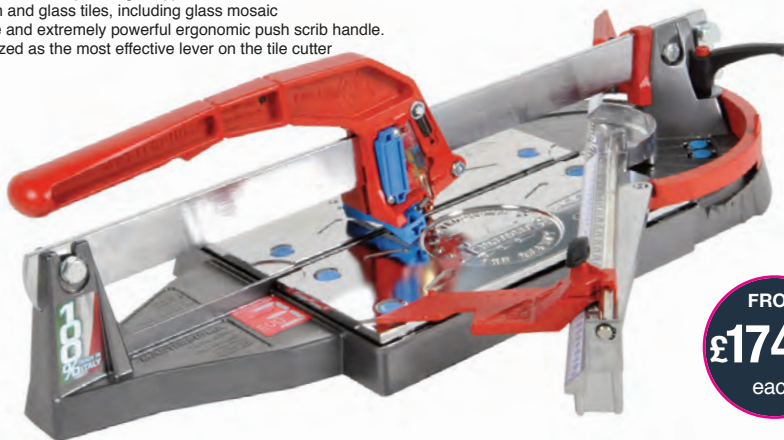

FROM
£174.99
each

Code	cm	Price	N4910008	75	£245.99
N4910002	44	£174.99	N4910010	93	£294.99
N4910004	52	£193.99	N4910012	125	£449.99
N4910006	63	£206.99	N4910014	155	£619.99



Montolit Minipiuma Manual Cutter

Mini version of the Masterpiuma manual breaker, suitable for use on small work top benches, c/w box

ONLY
£129.99
each



Code	cm	Price
N4910000	36	£129.99

Montolit Rubber Mosaic Mat

Rubber mat designed to be used with all sizes of Masterpiuma 3 manual tile cutters that allows the user to cut porcelain, ceramic and glass mosaics.

ONLY
£37
each



Code	suits	Price
N4910016	all sizes	£37

Montolit Masterpiuma 3 Manual Cutter Cover

Cover for all sizes of Masterpiuma 3 manual cutter

ONLY
£40
each



Code	suits	Price
N4910018	all sizes	£40

Montolit Titanium Cutting Wheel For Masterpiuma 3/ Minipiuma

Replacement titanium wheel and pin for Masterpiuma manual cutter

ONLY
£10.50
each



Code	suits	Price
N4910020	all sizes	£10.50

Montolit Cutting Handle for Masterpiuma 3 Manual Cutters

Replacement handle for Masterpiuma 3 manual cutters

ONLY
£60.50
each



Code	suits	Price
N4910024	all sizes	£60.50

Montolit Breaker for Masterpiuma 3 Manual Cutter

Replacement breaker for Masterpiuma 3 manual cutter

ONLY
£14.50
each



Code	suits	Price
N4910026	all sizes	£14.50

Montolit Measurement Guide for Masterpiuma 3 Cutters

Replacement measurement guide for Masterpiuma 3 manual cutters

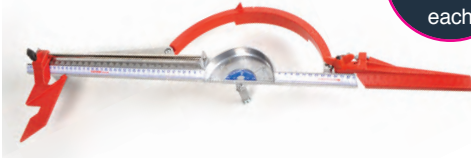

FROM
£65
each



Code	suits	Price
N4910028	44 & 52	£65
N4910030	63, 75 & 93	£73
N4910032	125 & 155	£77

Montolit Lateral Stop Square for Masterpiuma 3 Manual Cutters

Replacement lateral stop for Masterpiuma 3 manual cutters



ONLY
£16.75
each

Code	suits	Price
N4910034	all sizes	£16.75

Montolit Assorted Spare Parts Kit for Masterpiuma 3

Replacement parts for all size Montolit Masterpiuma manual cutters



ONLY
£18.75
each

Code	suits	Price
N4910035	n/a	£18.75

Montolit Replacement Base Plates

Replacement base plates for Masterpiuma cutters. 2 x bases, 4 x springs, 8 x caps



ONLY
£21
each

Code	suits	Price
N4910115	all sizes	£21

Montolit Replacement Measure Square Stop

Replacement Red Measurement Bar Extension



ONLY
£20
each

Code	suits	Price
N4910116	all sizes	£20

Montolit Replacement Locking Knob

Replacement locking knob for Masterpiuma



ONLY
£9
each

Code	suits	Price
N4910118	all sizes	£9

Montolit Replacement Locking Lever

Montolit Replacement Locking Lever



ONLY
£9
each

Code	suits	Price
N4910119	all sizes	£9

Montolit Replacement Rubber Feet

Genuine replacement rubber feet. To Fit all Masterpiuma Tile Cutters. Pack of 5



ONLY
£8
each

Code	suits	Price
N4910120	all sizes	£8

Montolit Replacement Breaker Feet

Replacement breaker feet for Masterpiuma. 10 per pack



ONLY
£6
each

Code	suits	Price
N4910121	all sizes	£6

Montolit Lubricant Oil for Masterpiuma 3 Manual Cutter 5 Pack

Replacement oil bprceer for Masterpiuma 3 manual cutters



ONLY
£6.50
each

Code	suits	Price
N4910036	all sizes	£6.50

Nicobond Pro Tile Cutter 600mm *

Bearing Cutter supplied with 6 & 10mm wheels, max cutting depth 16mm, Tungsten wheel, adjustable guide, extendable stand and spring loaded. Supplied in durable carry case.
 Max cutting length: 600mm
 Max cutting size for 45° angle: 420mm



ONLY
£89
 each

Code	cm	Price
N2540018	600	£89

Spare wheels

Code	cm	Price
N2540020	6	£3.50
N2540022	10	£4.00

Genesis Tile Cutter 600mm

Max cutting depth 10mm, Tungsten wheel,
 Max cutting length 600mm.

ONLY
£37.50
 each

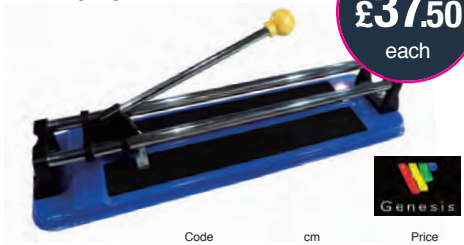

Code	cm	Price
984	600	£37.50

Genesis Tile Cutter 400mm

Max cutting depth 10mm, Tungsten wheel,
 Max cutting Length 400mm.

ONLY
£22.50
 each

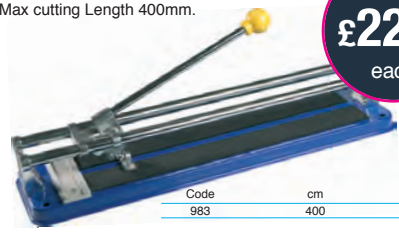

Code	cm	Price
983	400	£22.50

Spare wheel to suit Genesis Tile Cutters

Code	cm	Price
983W	-	£3.19



TX-MAX

Sigma Series 3

World renowned tile cutter known for it's ease of use, precision cutting, ability to produce consistent results and it's robustness, the Sigma Series 3 Max Professional Tile Cutter is a popular choice within the tile fixing industry. 5 year warranty.

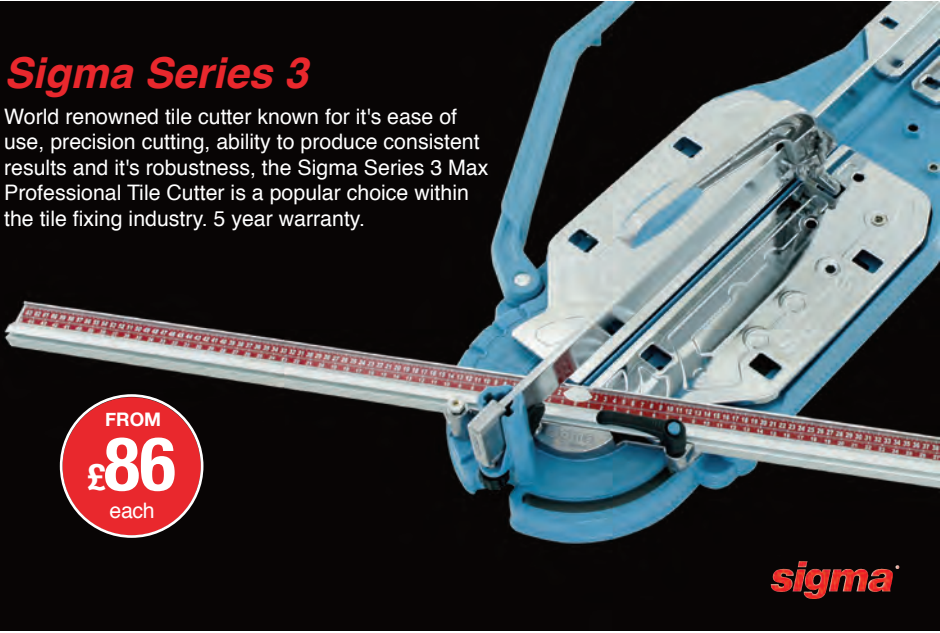

FROM
£86
each

sigma

Sigma Series 3 Max Professional Tile Cutter 3F4M 156cm

1560mm Straight cutting length.
1070mm x 1070mm tile cut diagonally.
Powerful 1300kg Breaker.
Weight 38.0kg.
5 year warranty.

ONLY
£583
each



Sigma Series 3 Max Professional Tile Cutter 3E4M 127cm

1270mm Straight cutting length.
894mm x 894mm tile cut diagonally.
Powerful 1300kg Breaker.
Weight 30.0kg.
5 year warranty.

ONLY
£466
each

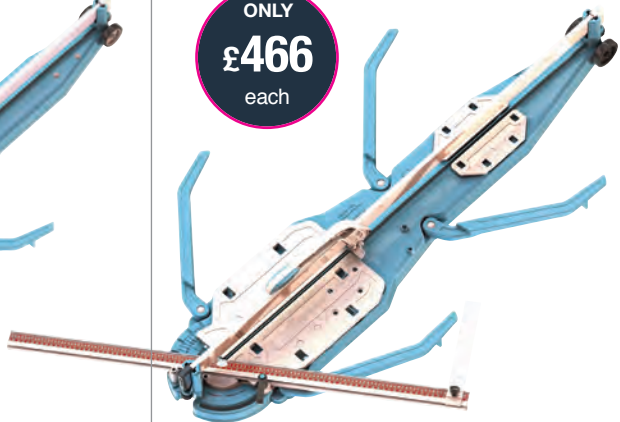

Code	cm	Price
N4920006	3F4M 156cm	£583

Code	cm	Price
N4920005	3E4M 127cm	£466

Sigma Series 3 Max Professional Tile Cutter 3L3M 50cm

505mm Straight cutting length.
357mm x 357mm tile cut diagonally.
Powerful 1150kg Breaker.
Weight 7.7kg.
5 year warranty.



ONLY
£205
each

Code	cm	Price
N4920000	3L3M 50cm	£205

Sigma Series 3 Max Professional Tile Cutter 3B4M 62cm

625mm Straight cutting length.
427mm x 427mm tile cut diagonally.
Powerful 1300kg Breaker.
Weight 11.8kg.
5 year warranty.

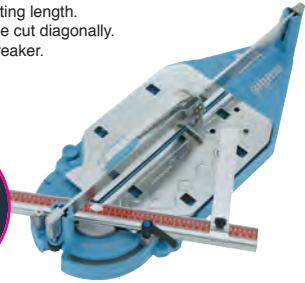

ONLY
£221
each

Code	cm	Price
N4920001	3B4M 62cm	£221

Sigma Series 3 Max Professional Tile Cutter 3C3M 72cm

725mm Straight cutting length.
513mm x 513mm tile cut diagonally.
Powerful 1300kg Breaker.
Weight 11.8kg.
5 year warranty.



ONLY
£272
each

Code	cm	Price
N4920002	3C3M 72cm	£272

Sigma Series 3 Max Professional Tile Cutter 3D4M 90cm

905mm Straight cutting length.
640mm x 640mm tile cut diagonally.
Powerful 1300kg Breaker.
Weight 13.5kg.
5 year warranty.



ONLY
£328
each

Code	cm	Price
N4920003	3D4M 90cm	£328

Sigma Series 3 Max Professional Tile Cutter 3P3M 100cm

1005mm Straight cutting length.
710mm x 710mm tile cut diagonally.
Powerful 1300kg Breaker.
Weight 19.0kg.
5 year warranty.



ONLY
£346
each

Code	cm	Price
N4920004	3P3M 100cm	£346

Sigma Series 3 2G Professional Tile Cutter

Popular small format tile cutter, perfect for smaller format tiles up to 37cm in length.

Pull to Score Tiles
370mm Straight cutting length.
260mm x 260mm tile cut diagonally.
15mm Maximum Cutting Thickness.
Powerful 600kg Breaker.
Weight 2.6kg.
5 year warranty.



ONLY
£86
each

Code	cm	Price
N4920007	2G 37cm	£86

Rubi TZ

For intensive cutting of all types of ceramic and porcelain tiles. Maximum power (up to 1500kg) offered by the most advanced manual cutter in the market. Robust chassis, guides and support base. Easy to transport with rubber wheels and handle. Interchangeable scoring wheels. Includes Ø 8mm and 18 mm scoring wheels. Reinforced textile bag for transport and protection.



FROM
£561
each

Code	cm	Price
N4900020	85	£561
N4900021	102	£579
17953	130	£775
17954	155	£827

Rubi TX-MAX

High-performance machine designed to cut the hardest ceramic materials on the market. Features include the 30 mm diameter tubular steel guides and its "Master Power" breaker which can be operated with one hand and has a maximum power of 1200 kg. This design is new to Rubi being the first breaker-scorer assembly which incorporates a ratchet lock with quick trigger release. This system allows scoring and breaking with great ease and with one hand. The base is cast aluminium to ensure robustness and lightness and incorporates a rotating square with central pivot for angular cuts. Includes two 8 and 22 mm scoring wheels and a case for its protection and handling.



FROM
£293
each

Code	cm	Price
17909	71	£293
N4900093	102	£354
17921	125	£507

Rubi TS-MAX (Grey base)

For intensive cutting of ceramic and porcelain tiles. Lightweight and functional with high performance 800kg breaker. Lateral stop for repetitive straight and 45° cuts. Interchangeable scoring wheels. Includes Ø 6mm and 10 mm scoring wheels and a transport case with reinforced locks and hinges.



FROM
£158
each

Code	cm	Price
N4900001	4	£158
N4900003	57	£192
N4900005	66	£234
N4900007	75	£256

Rubi TS-MAX (Orange base)

For intensive cutting of ceramic and porcelain tiles. Lightweight and functional with high performance 800kg breaker. Lateral stop for repetitive straight and 45° cuts. Interchangeable scoring wheels. Includes Ø 6mm and 10 mm scoring wheels and a transport case with reinforced locks and hinges.



FROM
£166
each

Code	cm	Price
18920	43	£166
18921	57	£192
18922	66	£235
18923	75	£260

Rubi TR Magnet

For intensive cutting of ceramic, wall tiles, floor tiles and stoneware. Suitable for diagonal cuts with a revolving square for high accuracy. Multi point breaker with 800kg power. Interchangeable scoring wheels. Ø 6mm and 10mm scoring wheels and bag-case included.



FROM
£243
each

Code	cm	Price
17905	60	£243
17906	71	£258

Rubi TQ Magnet

Ideal for professional cutting of porcelain stoneware and intensive cutting of glazed stoneware tiles.



FROM
£320
each

Code	cm	Price
14907	66	£320
14908	75	£330
14909	102	£378

Rubi TP-S

For high quality cutting of ceramics, also ideal for porcelain tiles. Single guide with multipoint separator and angular measurements. Designed for push scoring action. Ergonomic handle. 22mm scoring wheel included.



FROM
£193
each

Code	cm	Price
12954	66	£193
12956	75	£221
11900	93	£286

Rubi TP-T

For high quality cutting of ceramics, also ideal for porcelain tiles. Single guide with multipoint separator and angular measurements. Designed for pull scoring action. Ergonomic handle. 22mm scoring wheel included.



FROM
£204
each

Code	cm	Price
12955	66	£204
12957	75	£218
11901	93	£286

Rubi SPEED Magnet with case

For frequent cutting of all types of tiles. Multipoint breaker 800kg power. Interchangeable scoring wheels. Scoring wheel Ø 8 mm. included. 72/92 models: -Aluminium lateral support and bigger breaker system.



FROM
£170
each

Code	cm	Price
14988	62	£170
14989	72	£230
14990	92	£279

Rubi SPEED-N with case

For frequent cutting of glazed stoneware, wall tiles or occasional cuts of porcelain tiles. Interchangeable scoring wheels. Scoring wheel Ø 8 mm. included. 72/92 models: -Aluminium lateral support and bigger breaker system.



FROM
£171
each

Code	cm	Price
14985	62	£171
14986	72	£230
14987	92	£274

Rubi FAST

For cutting ceramic tiles. Wide foam base, lateral stop and 45° square. Interchangeable scoring wheels. Ø 6mm scoring wheel included.



FROM
£115
each

Code	cm	Price
13940	65	£115
13941	85	£148

Rubi FAST With Bag

For cutting ceramic tiles. Wide foam base, lateral stop and 45° square. Interchangeable scoring wheels. Ø 6mm scoring wheel included.



ONLY
£175
each

Code	cm	Price
13939	85	£175

Rubi STAR With Case

Light and versatile cutter for cutting ceramic tiles. Two-layer base with shock absorption. Interchangeable scoring wheels. Case and Ø 6mm scoring wheel included.



FROM
£59
each

Code	cm	Price
14946	42	£59
14947	51	£69
14948	63	£92.50

Rubi STAR

Light and versatile cutter for cutting ceramic tiles. Two-layer base with shock absorption. Interchangeable scoring wheels. Ø 6mm scoring wheel included.



FROM
£47
each

Code	cm	Price
14943	42	£47
14944	51	£58
14945	63	£82

Rubi BASIC- with lateral stop and 45° square

Ideal cutter for small renovations and light work. For ceramic tiles only. Complete with mobile breaker and Ø 14mm scoring wheel.



FROM
£28
each

Code	cm	Price
25955	50	£28
N4900018	60	£32

Rubi PRACTIC with lateral stop & 45° square

Ideal cutter for small renovations and light work. Interchangeable scoring wheels. Complete with mobile breaker and Ø 6mm scoring wheel.



FROM
£42
each

Code	cm	Price
24984	51	£42
24985	61	£49



Rubi POCKET with Case

Light and functional cutter for use in small working areas, for cutting ceramic tiles. Two-layer base with shock absorption. Interchangeable scoring wheels. Ø 6mm scoring wheel included.



ONLY
£47
each

Code	cm	Price
12981	42	£47

Rubi TS-MAX, TR-Magnet, TF-MAX and SPEED Magnet Scoring Wheels

Tungsten carbide scoring wheel.



FROM
£7.60
each

Code	mm	Price
N4016000	6	£7.60
N4016030	8	£8.70
01946	10	£10.00
01950	18	£14.00

Rubi TS-MAX, TR-Magnet, TF-MAX and SPEED Magnet Scoring Wheels

Tungsten carbide scoring wheel 2 wheel set



FROM
£15.50
each

Code	mm	Price
01947	6/6	£15.50
01948	6/10	£18.00

Rubi TS-MAX, TR-Magnet, TF-MAX and SPEED Magnet Scoring Wheels

Tungsten carbide with titanium coating GOLD scoring wheel



ONLY
£14.50
each

Code	mm	Price
01949	10	£14.50

Rubi Extreme Scoring Wheel

Tungsten carbide scoring wheel with titanium treatment for extra long life. Used for sharp scoring in hard materials



ONLY
£36
each

Code	mm	Price
N4900025	22	£36

Rubi TX and TZ Scoring Wheels

PLUS Tungsten carbide scoring wheel



ONLY
£11
each

Code	mm	Price
N4016040	8	£11
N4018500	10	£12
N4018502	18	£16

Rubi TX and TZ Scoring Wheels

PLUS Tungsten carbide with titanium coating GOLD scoring wheel



ONLY
£16
each

Code	mm	Price
01993	10	£16

Rubi TP Scoring Wheel

Adaptable tungsten carbide scoring wheel



ONLY
£9
each

Code	mm	Price
18914	22	£9

Rubi TP and Slim Scoring System Wheels



ONLY
£9
each

Code	mm	Price
18914	22	£9

Rubi Scoring wheel set 1

Ø6 and 10mm tungsten carbide scoring wheels in a plastic box suitable for TS-MAX, TR-MAGNET, TF-MAX, SPEED MAGNET, SPEED-N, FAST, STAR MAX, STAR, POCKET and PRACTIC cutters



ONLY
£16
each

Code	mm	Price
01995	6/10	£16

Rubi Scoring wheel set 2

Ø6, 8, 10, 18 and 22mm tungsten carbide scoring wheels in a plastic box suitable for TS, TS-PLUS, TR, TF, SPEED & SPEED MAGNET cutters.



ONLY
£38
each

Code	mm	Price
01996	/8/10/18/22	£38

Rubi SPEED, FAST, STAR MAX, STAR, POCKET, RAPID and PRACTIC Scoring Wheels

Tungsten carbide scoring wheel



FROM
£8
each

Code	mm	Price
01945	6	£8.00
01958	8	£9.00
N4016500	10	£9.50

Rubi Tungsten carbide scoring wheel 2 wheel set

Tungsten carbide scoring wheel



FROM
£14
each

Code	mm	Price
01947	6/6	£14
01948	6/10	£16

Rubi BASIC, KIT and TEN-BRIC Scoring Wheel

Tungsten carbide scoring wheel



ONLY
£4.35
each

Code	mm	Price
01960	14	£4.35

Rubi STAR and STAR-MAX lateral stop

Lateral stop for direct measuring



ONLY
£2.31
each

Code	cm	Price
12923	-	£2.31

Rubi POCKET Lateral stop

Metric lateral stop for POCKET manual cutters and STAR models before 2013



ONLY
£3.33
each

Code	cm	Price
12924	-	£3.33

Rubi TS-MAX and TF-MAX Lateral Stop

Metric lateral stop



ONLY
£12.31
each

Code	cm	Price
15749	-	£12.31

Rubi Maintenance Kit

Cleaning, lubricating and maintenance oil for regular maintenance of cutter parts that are regularly used



ONLY
£9
each

Code	cm	Price
18980	-	£9



Rubi T-41

Terrazzo cutter with maximum cutting length: 16" (41cm). Strength: 2,204.6Lb (1.000kg).

ONLY
£380
each



Code	cm	Price
05900	41	£380

Rubi T-51

Terrazzo cutter with maximum cutting length: 20" (51cm). Strength: 2,204.6Lb (1.000kg).

ONLY
£500
each



Code	cm	Price
05910	51	£500

Rubi B-13

Block cutter for cutting concrete blocks. Strength: 9,038.9Lb (4.100kg). Maximum cutting length: 12" (31cm). Width: 4" (10,5cm).

ONLY
£605
each



Code	cm	Price
05925	31	£605

Rubi B-14 S

Block cutter for cutting concrete blocks. Strength: 9,038.9Lb (4.100kg). Maximum cutting length: 16" (41cm). Width: 1"-6 1/8" (2,5-15,5cm)

ONLY
£770
each



Code	cm	Price
05931	41	£770

Rubi Roof tile cutter

Roof tile cutter with base for clay and concrete roofing tiles. Can cut in all directions.



Code	kg	Price
65922	6.8	£280

Rubi Cellular concrete saw

Beech wood and varnished handled saw with 29 Tungsten Carbide teeth. Length: 29" (75cm).



Code	cm	Price
70930	75	£54

Rubi Slate shear

Special shear for slates and fibre-cement.



Code	kg	Price
65924	n/a	£67

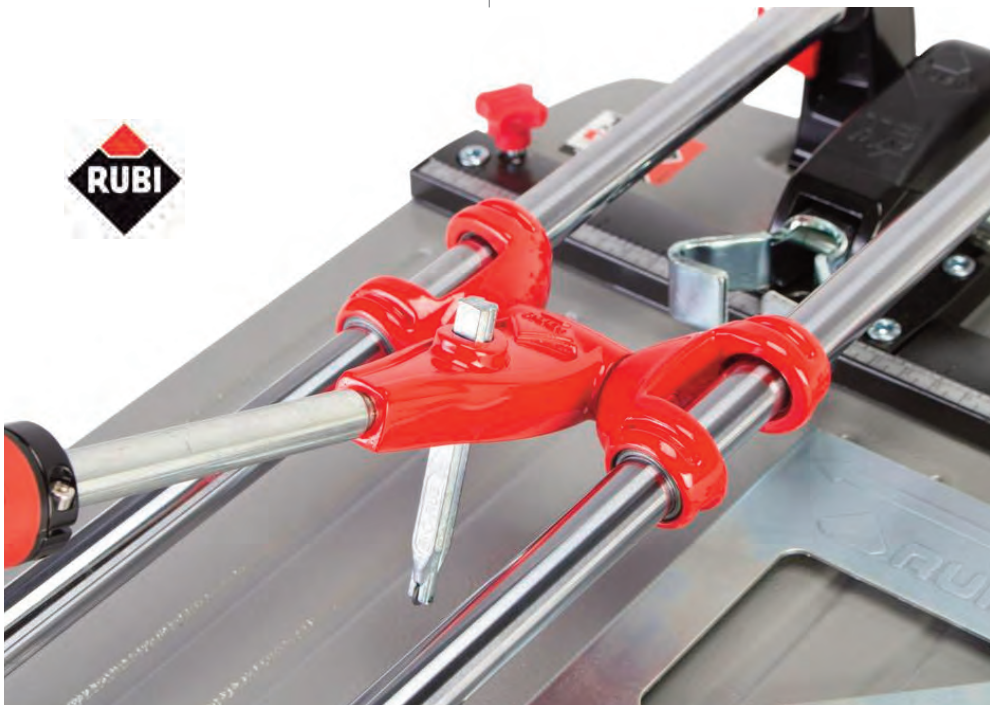

Rubi Du200 Evo 650 Electric Wet Tile Cutter 230v-50hz Uk (55905)

For cutting ceramic tiles and other materials. Features water cooling of the blade, lateral stop and direct drive. Includes CEV-PRO Ø200mm diamond blade and 1.5m electric cable)



ONLY
£269
each

Code	cm	Volt	Price
N4900015	65	230v-50 Hz.UK	£269

Rubi ND-180 Smart

Ideal for cutting ceramic floor and wall tiles. Single-phase motor. Ø 180mm Diamond blade and 1.5m electric cable included.



ONLY
£85
each

Code	cm	Volt	Price
N4900074	unlimited	230v-50 Hz.UK	£85

Rubi DC-250 ZERO DUST

Professional level machine for cutting ceramics, porcelain and stone. Single phase direct drive motor, 1.1 kW (1.5 hp). Water pump with flow control. Mobile head on bearings and foldable at 45 ° for mitre cuts. Includes diamond disc CEV-SUPERPRO Ø250 mm. Machine supplied without cable.



FROM
£735
each

Code	cm	Volt	Price
54933	98	230V-50 Hz. UK	£735
54935	98	120V-50 Hz. UK	£735
55941	120.5	230V-50 Hz. UK	£898
55943	120.5	120V-50 Hz. UK	£898

Rubi DX-250 PLUS Laser & Level

Professional level cutter for ceramic/ porcelain tiles, marble, granite and bricks. Equipped with protective head for safety in the use of segmented blades. Water pump cooling disk with regulator tap. Retractable legs with "shell" function and transport system on wheels. Work tables in aluminium and removable for cleaning. 2mW line laser. Machine supplied without cable. Takes Ø 250 mm (not included).



FROM
£1,202
each

Code	cm	Volt	Price
52900	112	230V-50 Hz. UK	£1,202
52910	152	230V-50 Hz. UK	£1,512

Rubi DX-350-N Laser & Level

Mobile head machine with plunge effect for total versatility. Motor on top and belt transmission. Circular level for easy field installation. Water pump refrigeration of blade with flow control valve. Aluminium working surface removable for easy cleaning. 2mW line laser. Machine supplied without cable. Allows the use of Ø300 and 350mm diamond blades



FROM
£1,710
each

Code	cm	Volt	Price
52905	118.5	230V-50 Hz. UK	£1,710
52915	148.5	230V-50 Hz. UK	£1,834
52917	148.5	120V-50 Hz. UK	£1,834
52919	148.5	380V/50 Hz.3F	£1,900

Rubi DR-350

Electric saw with plunge effect, capable of cutting all types of material including masonry bricks, facade bricks, fireproof bricks, marble, granite, ceramic and porcelain. Large table 23 1/16"x19 1/2" (58.5x49.5cm). Adjustable head to 45°. Direct drive. Diamond blade Ø300-350mm not included. Machine supplied without cable.



ONLY
£745
each

Code	cm	Volt	Price
56940	84	230V-50 Hz. UK	£745

Rubi Cleaning Block

For cleaning of diamond blades.



ONLY
£6.70
each

Code	cm	Price
05973	-	£6.70

Rubi N-Cleaning Block

Specifically designed to bring back the diamonds on the rim of diamond blades when cutting porcelain.



ONLY
£13
each

Code	cm	Price
N4900042	-	£13

Rubi Set of flanges DS-300 and DX-350

Great accuracy when making mitre cuts. Available in several models.



FROM
£40
each

Code	cm	Price
51915	-	£40
57991	-	£44

Rubi Base Lateral Stop DV/DC/DS/DX

Makes 45° cuts easier when finishing skirting boards. Precise adjustments to ensure parallelism of cut. Customised accessory for DV/DC/DS & DX cutters.



ONLY
£65
each

Code	mm	Price
51910	60	£65

Rubi Tile Fixer DV/DC/DS/DX

Allows the fixing of the ceramic during cutting, thus avoiding sudden movements. Accessory adaptable to DV,DC,DS and DX series (up to 2009).



ONLY
£70
each

Code	cm	Price
51916	-	£70

Rubi Roller Table Extension DV/DW-N/DC/DS/DX (from 2013)

Table extension with adjustable, foldable legs rollers to simplify movement of the tiles. Can be installed on both sides of the machines. Max weight 70kg.



ONLY
£185
each

Code	mm	Price
51914	675 x 575	£185

Rubi Table Extension DS/DX

(from 2014)

Increases work surface for large format ceramic tiles. Max weight 10kg



ONLY
£85
each

Code	mm	Price
54991	600 x 230	£85

Rubi Adjustable Length Lateral Stop DC/DS/DX

Adjustable to the maximum length of electric cutter. Stops lateral movement of tile while cutting. Especially suitable for blocking and execution of repetitive mitre.



ONLY
£50
each

Code	cm	Price
54844	-	£50

Rubi Longitudinal lateral stop for DV-200

Ideal for holding large pieces. Exclusive for DV-200 1000 model



ONLY
£47.50
each

Code	cm	Price
54984	121	£47.50

Rubi Lateral Stop for DW-NL/DC/DS/DX

Facilitates positioning of the ceramic, while reducing the percentage of errors. Accessory adaptable to DW-250-NL (up to 2012).



ONLY
£27
each

Code	cm	Price
54822	50	£27

Rubi Laser & Level Kit DV/DC/DS/DX

Kit includes a circular bubble level to facilitate proper positioning of the electric cutter, a laser line indicating the passage of the disc and facilitates placement of material. Laser is 2 mW class 2



ONLY
£20
each

Code	cm	Price
54999	-	£20

Rubi Cable with plug

Cable for machines supplied without cable.



ONLY
£20
each

Code	cm	Price
58852	3.5	110/50 UK £20
58853	3.5	230/50 UK £20



Rubi TC-180 230V / 50-60Hz

Electric saw for dry and wet cutting of large format ceramic tiles and natural stone. Kit contains 1 x Ø180mm TURBO TSV Blade, Parallel guide, Cable with PR CD switch (differential), 1 x cone reducer for vacuum cleaner and 1 x transport case.



ONLY
£415
each

Code	cm	Volt	Price
50939	unlimited	230	£415
50949	unlimited	110	£415

Rubi TC-180 230V/50-60HZ KIT 230/50-60 HZ

Kit includes 1 x Circular Cutter TC-180 230V 50/60Hz (Ref. 50939), 2 x Guide 80 cm. for TC-180 (Ref. 50956), 1 x Connector guides (Ref. 50957), 2 x Fixing Sergeant (Ref. 50958).



ONLY
£599
each

Code	cm	Price
50994	160	£599

Rubi Guide for TC-180

Aluminium guide for straight cuts, for use with TC-180. Ability to connect multiple guides through the connector (Ref. 50957)



FROM
£65
each

Code	mm	Price
50956	80	£65
50959	120	£90

Rubi Fixing C-clamp

Highly recommended for fixing the guide on the ceramic and preventing movement through out the cut, thus achieving a cleaner cut .



ONLY
£39
each

Code	cm	Price
50958	-	£39

Nicobond Diamond Hole Saw

Electro plated hole saws with diamond cutting rim and discharge holes. For use in slow speed drill and with water coolant



FROM
£6.54
each

Code	mm	Price
N2540024	5"	£6.54
N2540026	6	£5.97
N2540028	8	£7.11
N2540030	10	£8.28
N2540032	12	£9.96
N2540034	18	£16.50
N2540036	22	£20.49
N2540038	27	£23.97
N2540040	30	£29.94
N2540042	35	£31.89
N2540044	50"	£46.85
N2540046	63"	£56.91
N2540048	75"	£62.61
N2540050	115"	£93.75

Rubi Guide connector

Allows the connection of multiple guides to increase cutting length.



ONLY
£13
each

Code	mm	Price
50957	-	£13

Nicobond Triangular Ceramic Drill Bit

Drill bit for ceramic tiles to cut holes up to 73mm in diameter



ONLY
£10.50
each

Code	mm	Price
N2540266	up to 73	£10.50

Genesis Turbo Diamond Hole Saw

Suitable for drilling porcelain, marble granite and travertine. Electro plated diamond cutting rim with dust discharge hole. Use dry or wet with angle grinder



FROM
£13.60
each

Code	mm	Price
N2543008	6	£13.60
N2543010	8	£13.60
N2543012	20	£15.00
N2543014	25	£17.50
N2543016	28	£18.00
N2543018	35	£22.00
N2543020	50	£31.00
N2543022	60	£40.00
N2543024	70	£50.00

Genesis Drill Adaptor for Turbo Diamond Hole Saws

Adaptor allowing use of angle grinder hole saws in a drill



ONLY
£6
each

Code	mm	Price	Trade
N2543027	M14	£8.40	£6

Mondrillo Diamond Hole Saw

Vacuum braised diamond hole saw for fast, dry drilling of holes using an angle grinder



FROM
£60
each

Code	mm	Price
N4910090	18	£60
N4910092	25	£74
N4910094	35	£94
N4910096	40	£104

Mondrillo Diamond Drill Bit

Vacuum braised diamond drill bit for fast, dry drilling of holes using a hand held drill



FROM
£24
each

Code	mm	Price
N4910086	6	£24
N4910088	8	£25

Sigma Fast Series Diamond Hole Saw

Designed for dry or wet cutting through porcelain and ceramic tiles.



ONLY
£21
each

Code	mm	Price
N4920013	6	£21
N4920014	8	£21
N4920015	10	£21

Rubi Killer Gres Longlife Diamond Hole Saw *

Longlife, diamond hole saw with sintered technology for fast, dry cutting holes into porcelain up to 2cm thick.



ONLY
£109
each

Code	mm	Price
N4910098	35	£109

Rubi Mondrillo Cooling Fluid For Diamond Drilling

Specially designed cooling fluid to extend the life of diamond drilling bits up to 12mmØ



ONLY
£12.50
each

Code	mm	Price
N4910100	>12Ø	£12.50

Rubi Drill bit set with case

Kit consists of head with central drill attachment and 7 Tungsten Carbide drill bits in a plastic case



ONLY
£76
each

Code	mm	Price
4995	27/35/45/55/65/70/85	£76

Rubi DRYGRES drill bit

For drilling in dry wall, stoneware and porcelain tiles. Maximum operating speed 14,000 r.p.m. M14 thread finish. Usable with grinder (direct connection) or electric drill (adaptor ref. 05976).

FROM
£12.80
each



Code	mm	Price
N4900052	6	£12.80
N4900054	8	£14.00
N4900056	10	£15.00
N4900058	12	£15.80
N4900060	20	£25.00
N4900062	28	£29.00
N4900064	35	£38.00
N4900066	43	£43.00
N4900068	50	£46.00
04915	60	£60.00
04916	65	£68.57
N4900073	68	£67.00
05992	75	£72.00



Tungsten Carbide Drill Bit

Tungsten carbide drill bits for Wall tiles. Adaptable to manual drill and head for use with electric drill without hammer (ref. 04992).



FROM
£10
each

Code	mm	Price
04962	35	£10
04964	45	£11
04965	55	£12
04968	85	£20

Head with central attachment drill bit

Drill bit head with Tungsten Carbide tip for use with electric drill without hammer. For use with Tungsten Carbide drill bits.



ONLY
£7
each

Code	pk	Price
4992	1	£7

Rubi MULTIDRILL Guide

Drill guide with suction cup to assist drilling in tiles



ONLY
£22
each

Code	mm	Price
50944	max Ø 83	£22

Rubi DRYGRES Kit bits

The kit includes MULTIDRILL guide with case and dry cutting diamond drill bits as priced

FROM
£150
each



Code	mm	Price
50917	28/35/43/68	£150
50936	28/35/43/50/68	£180
50996	6/8/20/35/50/68	£170

Rubi Kit Mini DRYGRES

ONLY
£45
each



Code	mm	Price
N4900070	6/8/10/12	£45

Rubi Kit TCR Blade and DRYGRES drill bits

Drill bits and diamond blade for use with porcelain and ceramics. For use with grinders or drill (via adaptor) Kit includes 4 drill bits, TCR115 Diamond Blade adaptor and case.



ONLY
£90
each

Code	mm	Price
N4900072	6/6/20/35	£90

Rubi Drill bit DRYGRES 4DRILL HEX

For dry drilling wall tiles, stoneware, porcelain tiles and natural stone. Minimum working speed: 1500 r.p.m. Hexagonal connection without hammer. Ideal for batterypowered drills.

FROM
£13.90
each



Code	cm	Price
05923	6	£13.90
05924	8	£15.00
05926	10	£17.00
05927	12	£18.00
05928	14	£19.00
05929	20	£29.00

Rubi Kit DRYGRES 4DRILL 6,8,10,12 mm

For dry drilling wall tiles, stoneware, porcelain tiles and natural stone. Minimum working speed: 1500 r.p.m. Hexagonal connection without hammer. Ideal for batterypowered drills. Kit consisting of 4 drill bits & case

ONLY
£60
each



Code	mm	Price
05939	6/8/10/12	£60

Rubi Detachable MINIGRES drill bit head

Adapter for detachable diamond drill bits. Necessary to use with SWIVEL CONNECTOR (Ref. 50907). Thread 1/2" GAS.

ONLY
£10
each



Code	mm	Price
04937	Ø 6 - 14	£10

Rubi FORAGRES drill bit

To drill floor tiles, porcelain tiles, granite and marble. Always use cooled with water and non-hammer electric drill. Ø40 mm drill bit, designed for housing of toilet flushing mechanisms.



FROM
£43
each

Code	mm	Price
04970	20	£43
04971	28	£49
04972	35	£54
04963	40	£56
04981	43	£57
04973	50	£63
04974	65	£70
04918	68	£71
04975	75	£72
04976	100	£91
04977	120	£100

Rubi MINIGRES drill bit replacement

For drilling stoneware, porcelain, granite and marble. Always use water and electric drill without hammer. Necessary to use 1/2" threaded head (Ref. 04937) or Necessary to use 1/2" threaded head (Ref. 04937).

FROM
£15
each



Code	mm	Price
04930	6	£15
04931	8	£17
04932	10	£18
04933	12	£20

Rubi Kit FORAGRES

Kit includes MULTIDRILL Guide, Tank and hose, 6 diamond drill bits and case.



ONLY
£300
each

Code	cm	Price
50903	20/28/35/43/50/65	£300

Rubi FORAGRES guide

Support for electric drill. For the use of diamond drill bits for drilling stoneware, porcelain and granite. Drill adapter (Ref. 50915) included.

ONLY
£60
each



Code	pk	Price
50900	1	£60

Rubi Multidril Guide (Máx.Ø83 mm)

Fixes with a with sucker. Prevents drill bit from slipping on tile surface. Compatible with dry cutting diamond drill bits, removable diamond drill bits Ø 6-14 mm & wet cutting diamond drill bits Ø 20-75 mm. Includes hose & tank connection (Ref. 50947).

ONLY
£21.50
each



Code	mm	Price
50944	max Ø 83	£21.50

Rubi Tank and hose for MULTIDRILL guide

Tank with manual pressure pump. Includes 2m hose.

ONLY
£15
each



Code	ml	Price
50947	1200	£15

Rubi EASY GRES drill bit

Diamond drill bits for drilling ceramics, porcelain, granite, marble and glass. Must be used with EASY GRES guide for cooling. Average life between 5 and 10 holes depending on the material. Recommended speed of use between 400 and 1000 r.p.m. depending of the material to be drilled. To achieve a better finish and a longer life of the drill bit, it's important to observe the adequate speed of use and to apply a moderate pressure during the drilling.

FROM
£3
each

Code	mm	Price
04922	6	£3.00
04920	6.5	£3.20
04923	8	£3.50
04924	10	£3.90
04921	12	£4.50



Rubi EASY GRES drill bit

The EASY GRES guide allows holes both vertically and horizontally, thanks to its functional design incorporating a water tank with flow control valve. The EASY GRES guide attaches easily to any surface, thanks to its renewable adhesives.

Code	cm	Price
04927	6	£8.60
04925	6.5	£8.90
04928	8	£9.20
04929	10	£9.60
04926	12	£10.20
04919	6/10	£12.60
04909	6.5/10	£12.80



FROM
£8.60
each

Rubi EASY GRES 20 u.

Replacement adhesives for EASY GRES system



ONLY
£5.80
each

Code	pk	Price
4999	20	£5.80

Rubi KIT EASY GRES bits

Kit of EASY GRES drill bits



ONLY
£26.50
each

Code	mm	Price
04904	6/8/10/12	£26.50

Rubi EASY GRES drill bit

Electroplated diamond drills for use with electric drill without hammer for drilling stoneware, porcelain, granite, marble and glass. Always use water-cooled. The use of the MULTIDRILL guide (Ref. 50944) and the water tank (Ref. 50947) to cool and prevent movement of the drill bit during drilling getting good finishes. The working speed varies between 400 and 1000 r.p.m., depending on the material to be drilled. Average life of 10 holes, depending on the material .



FROM
£10.60
each

Code	mm	Price
5961	20	£10.60
5962	28	£13.00
5963	35	£14.90
5964	40	£16.00
5965	43	£16.40
5966	50	£16.70
5967	55	£18.00
5969	65	£19.80
5978	68	£20.00
5979	75	£20.50
5981	100	£31.00
5982	120	£37.00

Rubi EASY GRES drill bit Ø 1 3/8" (35 mm.) set



ONLY
£45
each

Code	mm	Price
50921	35	£45

Rubi Kit EASY GRES PLUS

Kit includes MULTIDRILL guide, water tank and hose and 7 drill bits



ONLY
£110
each

Code	mm	Price
50937	20/28/35/43/50/65/75	£110

Genesis Cyclone Diamond Cutting Blade 115mm

For wet and dry cutting of tiles. Unique segment blade design provides effective removal and fine cuts. Blade width: 2mm



ONLY
£20
each

Code	mm	Price
N2543000	115	£20

Genesis Continuous Rim Diamond Cutting Blade 115mm

High performance diamond blade for wet cutting glass, porcelain, granite, slate, marble and travertine. Blade width: 2mm

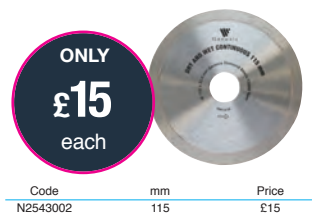

ONLY
£15
each

Code	mm	Price
N2543002	115	£15

Genesis Turbo Diamond Cutting Blade 115mm

Diamond turbo blade for wet and dry cutting of stone, concrete, and granite ceramics. Blade width: 2mm



ONLY
£18
each

Code	mm	Price
N2543004	115	£18

Rubi CPR-SUPERPRO

Recommended blade to cut fine porcelain tiles with less than 1" (25 mm.) thickness. The best finish. Only for straight cuts, not suitable for mitring.

FROM
£21
each



Code	mm	Price
30972	115 x 22.2	£21
30973	125 x 22.2	£23

Rubi CPJ-SUPERPRO

For cutting hard porcelain tiles with the best performance. Specially recommended for straight cuts and high speed cutting. Not for mitre. Thanks to J-Slot typology, this disc increases cutting speed on very hard porcelain tiles, while reducing the stresses generated through out the cut. It's original design is for dry cutting, but also allows wet cutting.

FROM
£26
each



Code	mm	Price
32932	115 x 22.2	£26
32933	125 x 22.2	£31

Rubi SON-SUPERPRO

Recommended blades to cut abrasive materials such as bricks, calcareous terrazzo, marble, sandstone. Only for straight cuts, not suitable for mitring.

ONLY
£56
each



Code	mm	Price
32908	230 x 22.2	£56

Rubi EMG-SUPERPRO

Recommended electroplated diamond blade to cut marble, limestone and fibres. Less vibration. To cut those materials with high risk of breaking, as marble and fibres. Only for straight cuts, not suitable for mitring.

FROM
£30
each



Code	mm	Price
30995	115 x 22.2	£30
30996	125 x 22.2	£30
30997	230 x 22.2	£58

Rubi CEV-PRO

Blade for general cut of ceramic tiles as wall tile, floor tiles, porcelain. To cut and mitre ceramic tiles and other stone coating materials with less than 1" (25 mm.) thickness.

Code	mm	Price
N4900044	180 x 22.2-25.4	£15.00
N4900046	200 x 25.4	£16.50
25934	250 x 25.4	£19.00

Rubi CEV-SUPERPRO

Code	mm	Price
N4900032	180 x 22.2-25.4	£27.00
N4900034	200 x 25.4	£29.00
30949	250 x 25.4	£37.00
30950	300 x 25.4	£65.00
30951	350 x 25.4	£78.00

FROM
£15
each



Rubi SHR-PRO

Recommended for cutting building materials such as brick, concrete, terrazzo. The fastest. Maximum speed and best blade's cooling. To cut materials with more than 1" (25 mm.) thickness.

Code	mm	Price
32974	250 x 25.4	£54
32972	300 x 25.4	£71

FROM
£54
each



SHR-SUPERPRO

Code	mm	Price
32971	350 x 25.4	£130



Rubi CPC-PRO

Recommended blade to cut fine porcelain tiles with less than 1" (25 mm.) thickness. Specially recommended for mitre cutting.



FROM
£37
each



Code	mm	Price
N4900030	180 x 22.2-25.4	£37
N4900036	200 x 25.4	£40
30958	230 x 22.2-25.4	£45
30959	250 x 25.4	£50
30960	300 x 25.4	£80
30961	350 x 25.4	£98

Rubi TVH-SUPERPRO

Recommended blade for cutting hard materials such as granite, rustic tiles, clinker, refractory, slate and porcelain tile. The specific design of the diamond band offers a greater speed of cutting harder materials without sacrificing finish quality. Only for straight cuts, not suitable for mitering.

FROM
£45
each



Code	mm	Price
N4900048	200 x 25.4	£45
31937	250 x 25.4	£57
31938	300 x 25.4	£76
31939	350 x 25.4	£108

Rubi CPA-SUPERPRO

Blades recommended for Hard Materials such as porcelain, Granite and slate with less than 1" (25mm) thickness. The best finish. To cut and mitre ceramic tiles and other stone coating materials with less than 1" (25 mm.) thickness.

FROM
£42
each



Code	mm	Price
30925	180 x 22.2	£42
30926	200 x 25.4	£49
30928	230 x 22.2	£55
30929	250 x 25.4	£64
30930	300 x 25.4	£90
30931	350 x 25.4	£99

Rubi CPX-PRO

Recommended disc to cut fine porcelain tiles. High Tech. High speed on straight cuts on porcelain tiles. Only for straight cut, not recommended for miter cuts.

FROM
£38
each



Code	mm	Price
30964	200 x 25.4	£38
30962	250 x 25.4	£42
30963	300 x 25.4	£75

Rubi TON-SUPERPRO

Recommended blades to cut abrasive materials such as bricks, calcareous terrazzo, marble, sandstone. A great combination. High performance and cutting speed with high standard finishes.

FROM
£43
each



Code	mm	Price
31906	200 x 25.4	£43
31909	250 x 25.4	£55
31910	300 x 25.4	£70

Genesis Diamond Multi Wheel

Diamond cup wheel for cutting and grinding. Can be used with porcelain, ceramic and natural stone. Time saving item that can be used to create awkward shaped cut outs and smooth finish the edges of tiles.



ONLY
£55
each



Code	mm	Grit	Price
N2543006	115	Medium	£55
N2543007	115	Fine	£55

Genesis Turbo Diamond Milling Bore

A versatile milling bit designed to enlarge, shape and/or round bevel existing holes in ceramic, porcelain and natural stones. A tool designed to save money, as with just one standard core bit and this milling tool, many different sized holes can be created.

FROM
£25
each



Code	mm	Price	Trade
N2543026	20	£30.76	£25

MontolitGold Line Diamond Segmented Cutting Blade DNA Evo3

High performance blade designed for fine cutting of porcelain, granite and marble. Designed for use on any electrical wet tile cutter. Pack comes with adapters (reductions) to suit cutter brand.

FROM
£103
each



Code	mm	Price
N4910070	180	£103
N4910072	200	£109

Montolit Gold Line Diamond Turbo Blade DNA Evo3

Diamond blade with a thicker blade for rapid cutting and 2cm thick procelain or hard stone. For use in an angle grinder

ONLY
£40.50
each



Code	mm	Price
N4910076	115	£40.50

Sigma Diamond Blade

Designed for dry cutting of porcelain and hard materials

ONLY
£30
each



Code	mm	Price
N4920016	115	£30

Rubi TCR-SUPERPRO

Recommended blade to cut fine porcelain tiles. High performance and fast cutting speed with high quality finishes. Only for straight cuts, not suitable for mitring.

FROM
£24.30
each



Code	mm	Price
N4900038	115 x 22.2	£24.30
31973	125 x 22.2	£25.40
31975	180 x 22.2	£36.00
31978	230 x 22.2	£62.00

Montolit Goldline Diamond Continuous Rim Dna Evo 3 Cutting Blade 115mm

High performance "hybrid" style diamond blade for dry or wet cutting porcelain. For use in an angle grinder

ONLY
£42.50
each



Code	mm	Price
N4910075	115	£42.50

Montolit Red Line Diamond Continuous Rim Blade

Specially designed 85mm Ø diamond blade which is only 1.2mm thick. It can be used to cut out square holes for sockets etc at just 4cm square

ONLY
£25
each



Code	mm	Price
N4910078	85	£25

Rubi TVA-SUPERPRO

Recommended blade for cutting hard materials such as granite, rustic tiles, clinker, refractory, slate and porcelain tiles. The specific design of the diamond band offer s greater speed of cutting harder materials without sacrificing finish quality. Only for straight cuts, not suitable for mitring.

FROM
£21.75
each

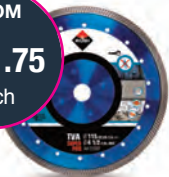

Code	mm	Price
N4900040	115 x 22.2	£21.75
31933	125 x 22.2	£26.00
31934	180 x 22.2	£39.00
31935	230 x 22.2	£51.00

Rubi RSQ-SUPERPRO

Recommended disc for cutting all types of materials including metal, plastic and wood and more. Vacuum Brazed Technology. Increased resistance to high temperatures during cutting, reduction of spark generated. High speed and performance. Only for straight cuts, not suitable for mitring.

FROM
£26
each



Code	mm	Price
N4900028	115 x 22.2	£26
30901	125 x 22.2	£30
30902	230 x 22.2	£55

Rubi TSV-PRO

Recommended for cutting building materials such as bricks, concrete, terrazzo. A great combination. High performance and cutting speed with high standard finishes. Only for straight cuts, not suitable for mitering.



Code	mm	Price
25917	115 x 22.2	£9
31980	125 x 22.2	£11
25918	230 x 22.2	£25
31982	125 x 22.2	£13

Rubi SEV-PRO

Recommended for cutting building materials such as brick, concrete, terrazzo. Fast speed and best blade cooling. To cut materials with more than 1" (25 mm.) thick. Perforated steel blade to improve cooling and diminish cut's tensions. Only for straight cuts, not suitable for mitering.



Code	mm	Price
25915	115 x 22.2	£9
32940	125 x 22.2	£11
25938	180 x 22.2	£14
25916	230 x 22.2	£23
32942	115 x 22.2	£17
32943	125 x 22.2	£19
32948	230 x 22.2	£48

Rubi CSV-PRO

Blade for general cut of ceramic tiles as wall tile, floor tiles, porcelain. The best finish. To cut ceramic tiles and other stone coating materials with less than 1" (25 mm.) thickness.

Code	mm	Price
25910	115 x 22.2	£8
31915	125 x 22.2	£9



Rubi CSV-SUPERPRO

Code	mm	Price
30882	115 x 22.2	£12.65
30883	125 x 22.2	£20.50
30888	230 x 22.2	£29.00

Rubi TSA-PRO

Recommended blades to cut hard materials such as granite, rustic tiles, klinker, fire bricks, slate. A great combination. High performance and cutting speed with high standard finishes. Only for straight cuts, not suitable for mitering.



Code	mm	Price
31952	115 x 22.2	£22.60
31953	125 x 22.2	£25.00
31956	180 x 22.2	£41.50
31958	230 x 22.2	£63.00

Rubi SHA-PRO

Recommended blades to cut hard materials such as granite, rustic tiles, klinker, fire bricks, slate. Only for straight cuts, not suitable for mitering.



Code	mm	Price
32922	115 x 22.2	£25
32928	230 x 22.2	£60

SHA-SUPERPRO

Code	mm	Price
32926	180 x 22.2	£55

Rubi SCA-SUPERPRO

Recommended for cutting high hardness natural stones such as granite, basalt, quartzite, concrete drive, etc. Long life and high performance. Bar of 12 mm. High speed cutting. For cutting materials > 25 mm thickness. Only for straight cuts, not suitable for mitering.



Code	mm	Price
30904	230 x 22.2	£60

Rubi STT-SUPERPRO

Recommended blade for cutting all types of building materials, included Reinforced concrete. High performance and speed of cutting. For cutting materials > 25 mm thickness. Only for straight cuts, not suitable for mitering.



Code	mm	Price
30974	115 x 22.2	£23
30975	125 x 22.2	£26
30976	230 x 22.2	£55

Genesis Diamond Multi Wheel

Specially designed disc with diamonds on both sides that enable difficult shapes to be cut into the edges of tiles

ONLY
£76
each



Code	mm	Grain	Price
N4910107	115	Fine	£76
N4910109	115	Medium	£76

Mondrillo Diamond Milling Bit

Diamond milling piece that fits to an angle grinder to allow shaping of holes and edges in porcelain tiles

ONLY
£51
each



Code	mm	Price
N4910103	6"	£51
N4910102	10"	£68
N4910104	20	£77

Montolit Topprofile Profiling Machine

Machine designed to be used with special diamond tools for chamfering and bull nosing tile edges

ONLY
£469
each



Code	v	Price
N4910055	110	£469

Montolit Topprofile Bevel Profile

Diamond tool used with Superprofile machine

ONLY
£152
each



Code	mm	Grain	Price
N4910057	15mm x 45°	medium	£152
N4910059	15mm x 45°	fine	£152

Montolit Topprofile Chamfer Profile

FROM
£114
each



Code	mm	degrees	Price
N4910061	3	45°	£114
N4910063	5	45°	£124

Montolit Topprofile Bull Nose (Batiscopa)

FROM
£114
each



Code	radius	Price
N4910065	3mm	£114
N4910067	5mm	£124
N4910069	10mm	£143

Rubi ECD 2 in 1 Cutting and Grinding Diamond Blade

For cutting and grinding ceramic, porcelain and natural stones.

ONLY
£44
each



Code	mm	Price
N4900027	115	£44

Rubi Support Floppy Polishing Pad

Fixing brackets for flexible polishing and buffing blades Ø100mm. Compatible with jobs dry and water-cooled. VELCRO fastening. Connection polisher / grinder with M14 thread.

ONLY
£10
each



Code	mm	Price
62986	Ø100	£10

Rubi Wet Diamond Polishing Pad

Floppy discs Ø100 mm for polishing, with water, concrete, marble, granite and other ornamental natural stones. For removing scratches and surface damage quickly and easily. Maximum operating speed: 4,500 rpm. # 50, # 100 and # 200 for roughing. # 400, # 800, # 1500 and # 3000 polishing and to close the pore. VELCRO® fastening to the disc holder ref. 62986.



Code	grain	Price
62978	50	£7
62979	100	£7
62980	200	£7
62981	400	£7
62982	800	£7
62983	1500	£7
62984	3000	£7

Rubi Wet Diamond Polishing Pad Buff.

Ø100 mm floppy disc for the final buffing, with water, of concrete, marble, granite and other ornamental natural stones. Natural and long-lasting shine.

Maximum operating speed: 4,500 rpm. VELCRO® fastening blade to holder ref. 62986.



Code	grain	Price
62985	buff	£8

Rubi Dry Diamond Polishing Pad

Floppy discs Ø100 mm for polishing, dry, of concrete, marble, granite and other ornamental natural stones. For removing scratches and surface damage quickly and easily. Maximum operating speed: 3,000 rpm. # 50, # 100 and # 200 for roughing. # 400, # 800, # 1500 and # 3000 polishing and to close the pore. VELCRO® fastening to the disc holder ref. 62986.



Code	grain	Price
62970	50	£7
62971	100	£7
62972	200	£7
62973	400	7
62974	800	£67
62975	1500	£7
62976	3000	£7

Rubi Dry Diamond Polishing Pad

Ø100 mm floppy disc for the final buffing, with water, of concrete, marble, granite and other ornamental natural stones. Natural and long-lasting shine. Maximum operating speed: 3,000 rpm. VELCRO® fastening blade to holder ref. 62986.



Code	buff	Price
62977	buff	£7

Nicobond Diamond Hand Pad

For smoothing the edges of any type of marble, granite, porcelain, stoneware and ceramics. Medium pad for smoothing the edges of all types of tile



Code	finish	colour	Price	Trade
N2540190	Fine	Red	£35.69	£25
N4910067	Medium	Blue	£35.69	£25

Nicobond Diamond Manual Polishing Pad

Range of diamond rubber pads for roughing and edge polishing, cutting and surfaces of natural stone and ceramic tile. Semi-flexible. Good adaptation to the user's hand. Recommended to be used with water. # 60, # 120 and # 200 for roughing. # 400 for polishing. Dimensions of the diamond plate: 55x90 mm. Rubber pad dimensions: 58x94x30 mm.



Code	grit #	Price
61974	60	£17.50
61975	120	£17.50
61976	200	£17.50



Dust Extraction

Drilling - Small

- Collects dust and water while drilling
- Flexible rubber gasket that maintains the connection with a vacuum nozzle (diameter of 25-35mm)
- Suction that seals even on uneven surfaces
- Accommodates hole saws up to 14mm
- Supplied with adaptor for connecting to vacuum cleaner

Drilling - Large

- Flexible rubber gasket that maintains the connection with a vacuum nozzle (diameter of 25-35mm)
- Suction that seals even on uneven surfaces
- Suitable for drilling up to 14-72mm hole saws
- Supplied with adaptor for connecting to vacuum cleaner

Cutting

- Collects dust when cutting with an angle grinder
- Flexible rubber gasket that maintains the connection with a vacuum nozzle (diameter of 25-35mm)
- The unit itself comes complete with a guide slot for precise cutting and bushings to suit most common angle grinders
- Suitable for blades with a diameter of 100-125mm
- Supplied with adaptor for connecting to vacuum cleaner

Code	mm	Price
B334502	Drilling - Small	£21.25
B334500	Drilling - Large	£23.75
B334504	Cutting	£48.13





RUBI

CYCLONE LEVEL SYSTEM

FASTER PERFECT LEVELING

- 1** A tool is not required for their installation. Recommended for tiles with thickness from 3 to 20mm.
- 2** EASY, QUICK and INTUITIVE to USE.
- 3** LARGE and ERGONOMIC Cap. Does not injure fingers when tightening. Reusable caps.

- System removal by IMPACT (kick or mallet). ALWAYS in the direction of the grout joint.
- The base of the clip ensures continuous tension between the clip and the cap.

**BUILDING THE
FUTURE TOGETHER**

Large Format Tile Cutting & Lifting

for the Trade



BIHUI Beater & Spacer Bundle

BIHUI Vibration Tile Beater V2
PLUS BIHUI Tile Space Regulator

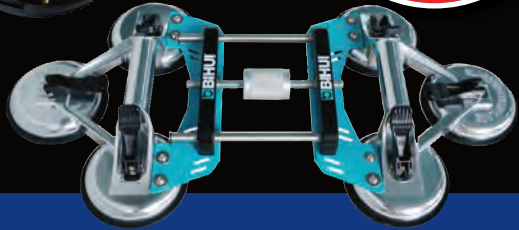

Only
£245
Bundle Price

BIHUI Tile Space Regulator

For positioning and fine-tuning of large-format and heavier materials with a smooth surface, such as stone, granite, metal and glass.

- 6 suction cups
- Span between 170 - 225mm
- Width: 350mm. Length: 655mm

ONLY
£168
each



Code	Price
BLFTGP	£168

BIHUI Transport Cart

The ideal solution to move large format slabs of porcelain stoneware in the warehouse, places of installation offering work area to apply the adhesive. Features 4 soft rubber castors (lockable) positioned on each corner for superb control movement and direction is created plus they make it extremely stable.

Height: 1500mm Width: 1500mm
Depth: 750mm Max Load: 280kg



ONLY
£445
each

Code	Price
BLFCART	£445

BIHUI Lifting System for Large Format Tiles

Robust and stable plate lift for large format plates

- Adjustable rail system, max capacity 3.2 x 1.6m
- Max lifting capacity 130 kgs
- Soft grip easy access handles"



ONLY
£999
each

Code	Price
BLFCSF	£999

BIHUI Battery Powered Vacuum Suction Handle

Designed for the professionals, the vacuum-assisted lifting technology transforms the traditional method of heavy lifting.

- Voltage 14.8V
- Charging time 1 Hour
- Max lift 70 kg
- Set includes 2 batteries
- Battery life indicator



ONLY
£305
each

Code	Price
BLFEVS	£305

BIHUI Workbench

A lightweight, robust and stable workbench for large-format tiles, enabling cutting / drilling without risk of damaging the work surface. Easily assembled for transport and storage and can be mounted together with additional tables for increased work surface, features includes foldable legs and adjustable rails.

- Connect 2 benches for 3600mm length
- Height: 800mm
 - Width: 1400mm
 - Length: 1800mm
 - Max Load: 200kg



ONLY
£560
each

Code	Price
BLFWBO	£560

BIHUI Manual Rail Cutting System

For manual cutting of large format tiles with thicknesses between 3 and 6mm. Packed in plastic case and tool bag, this 3 rail system has a cutting ability of up to 3.6m. Easily assembled for transport and storage and can be mounted together with additional tables for increased work surface, includes:

- 1 x Cutting head
- 2 x Cutting wheel
- 3 x Aluminum suction cup
- 1 x Breaking plier
- 2 x Break clamp device
- 2 x F Clamp



ONLY
£470
each

Code	Price
BLFMCR	£470

BIHUI Electric Cutter

An electric dry cutter compatible with the BLFMCR rail system for large format tiles.

- 1500W, 220V
- 13000 rpm
- Max cutting depth 14mm



ONLY
£313
each

Code	Price
BLFECM	£313

BIHUI Heavy Duty Vacuum Suction Cup

Heavy duty suction cup with full suction visual guide for lifting up to 110kg

- Ø 200mm
- Pump action
- Quick release
- Outer ring ideal for textured tiles
- c/w protective carry case



ONLY
£80
each

Code	Price
BU-SCV08	£80

BIHUI Vibration Tile Beater V2

Compact & lightweight. Allows positioning through the suction cup, the vibration removes trapped air bubbles in adhesive. c/w adjustable vibration, integral level & working light.

- Lithium battery
- Voltage 16.8V
- Charging time: 2 Hrs
- Battery life indicator
- Max. lift: 35kg



ONLY
£84
each

Code	Price
BU-LFTBV	£84

Montolit Goal Evo Slab Transport System

Wheeled trolley designed for moving large format tiles. Can be used in conjunction with Superlift system

ONLY
£490
each



Code	swl kg	Price
N4910039	260	£490

Montolit Basic Tile Lifting System

Basic system with rail and two suction cups for lifting large format tiles and slabs

ONLY
£395
each



Code	swl kg	Price
N4910131	40	£395

Montolit Superlift Full Kit

System for lifting and carrying large format tiles up to 300x150cm. Complete with 4 suction cups

ONLY
£980
each

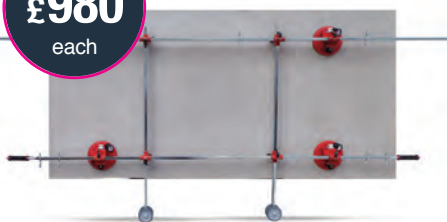

Code	swl kg	Price
N4910041	80	£980

Montolit Superlift Extra Suction Cup

Extra suction cups for Superlift system



ONLY
£160
each

Code	swl kg	Price
N4910043	20	£160

Montolit Superlift Safety Hooks

Hooks used with Montolit Superlift kit to ensure safe moving of slabs with a rough surface

ONLY
£175
each



Code	pack	Price
N4910114	Pack of 4	£175

Montolit Work Table

Aluminium table specially designed for cutting and drilling large format/ slab tiles

ONLY
£545
each



Code	CM	Price
N4910051	240x150	£545

Large Format and Specialist Tiling Tools



Vibration Tile
Beater BU-LFBTV

BIHUI is at the forefront of innovation and development of specialist tiling tools for advanced handling and installation of large format tiles.

The products are manufactured using the latest technology, with focus on design and functionality in every detail.

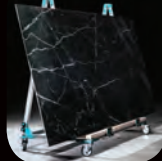

Genesis

For the Perfect Finish



SINCE 1946

The Cutting Revolution for Large Format Tiles

FLASH *LINE* FL3



**COMPLETE MANUAL CUTTING SYSTEM FOR
PORCELAIN, CERAMIC OR GLASS TILES AND SLABS**



• TITANIUM WHEELS SELECTION SYSTEM

• Non-slip system without suction cups

• Quick elastic connection

• "No Limits" extendable system with rails

• **INTERNATIONAL PATENT · 100% MADE IN ITALY**

Montolit Tile Levelling Lifters

Pair of telescopic lifters for levelling large format tile on a wall. Max height 30cm

ONLY
£50
each



Code	swt kg	Price
N4910127	30	£50

Montolit Battle Pro Thumping Suction Cup - 2B edition

Cordless power tool used as a suction cup for lifting tiles and as a vibrating pressure tool to effectively embed large format tiles. Comes c/w expander plate and 2 batteries

ONLY
£235
each



Code	voltage	Price
N4910129	16v	£235

Montolit FL3 Flashline Large Format Tile Cutting System c/w Carrying Bag

Portable system for manual cutting of long slim tiles up to 3.4m

ONLY
£375
each



Code	Price
N4910045	£375

Montolit Titanium Cutting Wheel for FL3 Flashline

Replacement scoring wheel for FL3 Flashline Cutting System

FROM
£10
each



Code	size	Price
N4910046	8mm	£10
N4910047	10mm	£11
N4910113	20mm	£12

Montolit Moto 2 Flashline Electric Cutter 110/120v (Unit only)

Portable electric cutter with diamond blade that can be used with Flashline rail system for cutting tiles up to 3m long and 2cm thick

ONLY
£550
each



Code	voltage	PRICE
N4910049	110/120	£550

Montolit Moto 2 Flashline Electric Cutter 110/120v Kit c/w Flashline Rails

Portable system for manual cutting of long slim tiles up to 3.4m using diamond blades, c/w carrying cases

ONLY
£700
each



Code	voltage	PRICE
N4910053	110/120	£700

Montolit Tile Corner Protectors

Shaped plastic covers to protect the corners of slabs when using slab lifting equipment. Pack of 4 pieces



FROM
£11
pack

Code	Size	Price
N4910123	3-4mm	£11
N4910124	5-6mm	£13
N4910125	8-10mm	£15
N4910126	11-12mm	£17

Montolit Slab Lifting Handle

Simple lifter for tiles up to 600mm



ONLY
£75
each



Code	mm	Price
N4910052	>650	£75

Rubi TC-125 Circular Cutter Kit

For cutting all types of ceramic sheets and tiles. Suitable for use with natural and sintered stone. Especially for large/ slab tiles. Kit includes cutter, rail system, disc and carry cases/ bags. Use with 125mm blade.



ONLY
£440
each

Code	mm	Price
51902	230	£440
51904	110	£440

Montolit Red Line Diamond Blade

A range of 150mm Ø diamond blades suitable for use with the Montolit Flashline Electric Cutter. Continuous rim for regular thickness porcelain.

- Turbo Blade for
- 2cm thick porcelain
- Segmented Blade for slim porcelain

FROM
£55
each



Code	Size	Price
N4910080	Continuous Rim	£60
N4910082	Turbo Rim	£55
N4910084	Segmented Rim	£60

Montolit Vacuum suction pad for Slab Trans Heavy Duty

Can be used as an additional cup for extra security in case of suction failure.



ONLY
£72
each

Code	Price
18827	£72

Rubi TC-125 Circular Cutter

For cutting all types of ceramic sheets and tiles. Suitable for use with natural and sintered stone. Especially for large/ slab tiles. C/w case and blade. Use with 125mm blade.



ONLY
£225
each

Code	mm	Price
51959	230	£225
51961	110	£225



Rubi Slim System Easy Trans

Ideal system for easy transportation of large format porcelain sheets up to 3m long. Includes two extendable & adjustable guides 160cm & 320cm with 10 suction pads.

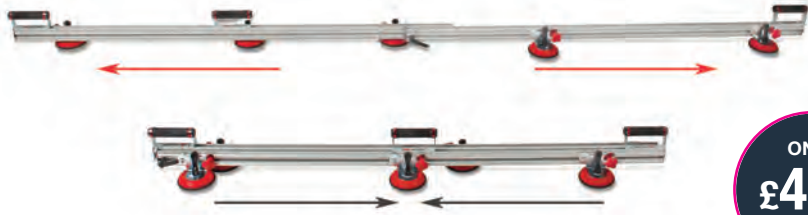

ONLY
£455
each

Code	swl kg	Price
18910	60	£455

Rubi Slim System Easy Trans Supplementary Guide Set

Set of perpendicular guides for increased stability. Increases the rigidity of the unit.



ONLY
£214
each

Code	swl kg	Price
18819	-	£214

Rubi Slab Trans Heavy Duty

Lifting equipment for porcelain slab. Especially suited for handling thicker pieces. Reinforced aluminium profile. 2 perpendicular aluminium guides, for greater stiffness. Includes 6 vacuum suction cups. Black anodized finish. Size 165cm to 320 cm.



ONLY
£1320
each

Code	swl kg	Price
18936	140	£1320

Rubi Slim System Cutter

For hand cutting, large format porcelain, between 3mm & 8mm thick. Cutting capacity of up to 310cm. The set consists of 3 x 110cm guides, roller guide with scoring wheel, pincers, 2 x suction pads and carrying case.



ONLY
£265
each

Code	cm	Price
18911	310	£265

Rubi Slim System Cutter Guide

Additional extension guides for use with Slim System Cutter

ONLY
£47
each



Code	cm	Price
18913	110	£47

Rubi Slim Separator

Auxiliary breaker for use with slim system cutter for tiles 6mm or more

ONLY
£105
each



Code	cm	Price
18917	-	£105

Rubi Triller Electric Tamping System

240v corded tamping system used to remove air from adhesive below large format slabs and tiles

ONLY
£285
each



Code	cm	Price
18948	240	£285

Large Format Tiling System Specialists



- Large Format Wall and Floor Tiles
 - Slabs for Commercial and Domestic Projects
 - Manufacturers of High Grab Large Format Adhesive
 - Professional Tiling Systems for Problematic Substrates
 - Smoothing compounds for flooring professionals
 - Professional Levelling Systems and Tiling Accessories
 - Lifting platforms for Easier Handling and Application
 - Diamond Cutting, Drilling and Profiling Products
-

Tiling Tools & Consumables

for the Trade



Only
£18.95
300 piece kit
N2541101



**Clip & Wedge Tile Levelling System
1.5mm Kit - 200 Clips and 100 Wedges
c/w Reusable Plastic Bucket**

Nicobond Soft Grip Gauging Trowel

Gauging trowel with steel blade and soft grip handle

ONLY
£3.50
each



Code	mm	Price
N2540064	178	£3.50

Nicobond Soft Grip Round Notched Trowel

20 x 10mm soft grip round notch trowel for floor tiles

ONLY
£6
each



Code	mm	Price
N2540058	280 x 115	£6

Nicobond Soft Grip Square Notched Trowel 4mm

Soft grip square notched trowel 4 x 4mm for wall tiles

ONLY
£6
each



Code	mm	Price
N2540059	280 x 115	£6

Nicobond Soft Grip Square Notched Trowel 6mm

Soft grip square notched trowel 6 x 6mm for wall tiles

ONLY
£6
each



Code	mm	Price
N2540060	280 x 115	£6

Nicobond Soft Grip Square Notched Trowel 8mm

Soft grip square notched trowel 8 x 8mm for wall & floor tiles

ONLY
£6
each



Code	mm	Price
N2540061	280 x 115	£6

Nicobond Soft Grip Square Notched Trowel 10mm

Soft grip square notched trowel 10 x 10mm for wall & floor tiles

ONLY
£6
each



Code	mm	Price
N2540062	280 x 115	£6

Nicobond Soft Grip Large Format Floor Tile Trowel

Soft grip with unique tooth design for improved coverage



ONLY £6.50 each

Code	mm	Price
N2540194	280 x 130	£6.50

Nicobond Soft grip Bucket Trowel

Specially shaped for effective use with buckets



ONLY £3.50 each

Code	mm	Price
N2540066	160	£3.50

Nicobond Screeding Trowel

Trowel designed for use with screeds under smoothing compounds



ONLY £6 each

Code	mm	Price
F6102016	280 x 130	£6

Nicobond Trowel Handle

For Use With Notched Blades
Trowel handle for notched blades



ONLY £9 each

Code	mm	Price
F6102020	275 x 110	£9

Nicobond Trowel Notched Blades

For Use with Trowel handle
Primarily for use with carpet & vinyl adhesives



ONLY £3.50 each

Code	mm	Price
F0000031	2	£3.50
F0000032	1.5	£3.50
F0000033	1	£3.50

Sigma Stainless Steel Notched Trowels

Stainless steel trowel with soft ergonomic grip **sigma**



ONLY £10.80 each

Code	mm	notch	Price
N4920011	280 x 130	4 x 4	£10.80
N4920012	280 x 130	10 x 10	£10.80

Genesis Stainless Steel Trowel Sets

- Stainless steel blades
- Interchangeable handle
- Square notch 4,6,8 & 10mm
- 10 x 20mm round notch
- Tiger trowel
- V notch x 5
- Screeding blade

FROM £7.50 each



965SET - Blades Included

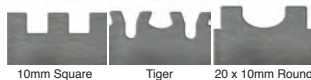
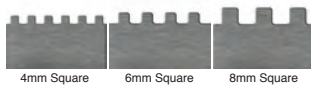

965FTS - Blades Included

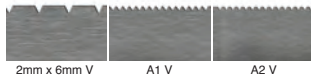
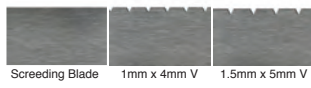

Code	Description	Price
965SET	6 blade set	£31.20
965BS4	4mm Square Notch	£7.50
965BS6	6mm Square Notch	£7.50
965BS8	8mm Square Notch	£7.50
965BS10	10mm Square Notch	£7.50
965BTG	Tiger	£7.50
965BR20	20 x 10mm Round Notch	£7.50
965HDL	Handle	£7.50

Code	Description	Price
965FTS	6 blade set -Flooring	£44.50
965BSC	Screed	£7.50
965BV104	1mm x 4mm notch	£7.50
965BV155	1.5mm x 5mm notch	£7.50
965BV206	2mm x 6mm notch	£7.50
965BVA1	A1 notch	£7.50
965BVA2	A2 notch	£7.50
965HDL	Handle	£7.50

Genesis Extra Large Screeding Blade



ONLY £15 each

Code	mm	Price
965BSCXL	2	£15

Genesis Float Attachment



ONLY £12.50 each

Code	Price
965FLT	£12.50

Rubi trowels & notched trowels closed wood handle



FROM
£6.55
each

30cm STEEL trowel.

Steel plate special high wear resistance with corrosion protection by clear coat

Code	mm	Price
65950	n/a	£6.55

30cm INOX trowel.

Stainless steel plate special high wear resistance

Code	mm	Price
65960	n/a	£8.52

30cm Sharp edged INOX trowel.

Stainless steel plate special high wear resistance.

Code	mm	Price
74948	n/a	£18.45

28cm STEEL notched trowel.

Steel plate special high wear resistance with corrosion protection by clear coat

Code	mm	Price
65989	3x3	£6.55
65982	6x6	£6.55
65985	10x10	£6.55
74947	12x12	£6.55

Rubi spatulas & notched spatulas wood handle



ONLY
£3
each

18cm STEEL spatula. Special steel high wear resistance..

Code	mm	Price
71922	n/a	£3

18cm STEEL notched spatula. Special steel high wear resistance

Code	mm	Price
71923	3x3	£3
71924	6x6	£3
71925	8x8	£3
71926	10x10	£3
71927	3x3 triangular	£3

Rubi 19"(48cm) trowels & notched trowels closed wood handle



FROM
£13.76
each

48 cm STEEL trowel.

Steel plate special high wear resistance with corrosion protection by clear coat

Code	mm	Price
65988	n/a	£13.76

48cm INOX trowel.

Stainless steel plate special high wear resistance

Code	mm	Price
72915	n/a	£14.15

48cm STEEL notched trowel. .

Steel plate special high wear resistance with corrosion protection by clear coat

Code	mm	Price
65958	6x6	£13.76
65959	8x8	£13.76
65983	10x10	£13.76
73973	12x12	£13.76
75962	20x20	£13.76

Rubi Levelling trowel

Levelling trowels wood handle. Special high wear resistant steel plate. Plate measures 40 x 11 cm



ONLY
£31.25
each

Code	tip	Price
60996	rounded	£31.25
60997	pointed	£31.25

Rubi trowels & notched trowels closed RUBIFLEX handle



FROM
£8.21
each

30cm STEEL trowel.

Steel plate special high wear resistance with corrosion protection by clear coat

Code	mm	Price
75950	n/a	£8.21

30cm INOX trowel.

Stainless steel plate high wear resistance.

Code	mm	Price
75970	n/a	£9.57

28cm STEEL notched trowel.

Steel plate special high wear resistance with corrosion protection by clear coat

Code	mm	Price
75955	6x6	£8.21
75957	8x8	£8.21
75958	10x10	£8.21
75959	12x12	£8.21

Rubi trowels & notched trowels open RUBIFLEX handle



FROM
£9.81
each

28cm STEEL notched trowel.

Steel plate special high wear resistance with corrosion protection by clear coat

Code	mm	Price
72906	3x3	£9.81
74980	4.5x4.5	£9.81
72907	6x6	£9.81
74981	6x10	£9.81
72908	8x8	£9.81
72909	10x10	£9.81
74982	10x12	£9.81
72910	10 round	£9.81
72911	6x5 triangular	£9.81

28cm INOX trowel.

Stainless steel plate high wear resistance.

Code	mm	Price
72919	-n/a	£10.97

28cm INOX notched trowel.

Stainless steel plate high wear resistance.

Code	mm	Price
74936	3x3	£10.97
74937	4.5x4.5	£10.97
74938	6x6	£10.97
74940	8x8	£10.97
74941	10x10	£10.97
74942	12x12	£10.97

Rubi trowels & notched trowels closed plastic handle



ONLY
£5.10
each

30cm STEEL trowel.

Steel plate special high wear resistance with corrosion protection by clear coat.

Code	mm	Price
65951	-n/a	£5.10

28cm STEEL notched trowel.

Steel plate special high wear resistance with corrosion protection by clear coat.

Code	mm	Price
65965	3x3	£5.10
65966	6x6	£5.10
65967	8x8	£5.10
65968	10x10	£5.10

Rubi 45° Notched trowel Rubiflex open handle

28cm 45° Notched trowel. Special carbon steel alloy plate of high wear resistance.

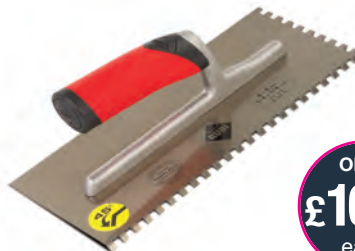

ONLY
£10.13
each

Code	mm	Price
75946	6x6	£10.13
75947	8x8	£10.13
75948	10x10	£10.13
75923	12x12	£10.13
75924	10 round	£10.13



Rubi Trowels open plastic handle



FROM
£3.29
each

28cm STEEL trowel.

Steel plate. Special high wear resistance.

Code	mm	Price
25900	n/a-	£3.29

28cm STEEL notched trowel.

Special high wear resistance.

Code	mm	Price
25901	3x3	£3.29
25902	4.5x4.5	£3.29
25903	6x6	£3.29
25905	8x8	£3.29
25906	10x10	£3.29
25907	12x12	£3.29

Nicobond Grout Float

Professional grout float with wooden handle



ONLY
£6
each

Code	mm	Price
N2540100	240 x 102	£6

Nicobond Float Epoxy Grout Float

Light weight body with dense green rubber pad for the application of epoxy grouts. 18° and 42° edges for differing grout densities



ONLY
£5.50
each

Code	mm	Price
N2540103	248 x 116	£5.50

Sigma Grout Float with Interchangeable Handle

Professional grout float with ergonomic handle and rubber face. Interchangeable handle can be used with wash boy sponge base



ONLY
£7.36
each

Code	mm	Price
N4920010	248 x 116	£7.36

Rubi Grout floats Superpro Wood

For grouting ceramic, wood ergonomic handle.

Available in different hardnesses of rubber for best finish as the joint width. Rubber float trowel, with white rubber sheet wear resistant. Solid rubber float, with hard rubber abrasion resistant. Thermoflex float, medium hardness.



FROM
£9.72
each

Code	Type	Price
65970	Rubber	£12.33
65976	Thermoflex Rubber	£9.72
65975	Solid Rubber	£10.98

Rubi Grout Floats Superpro Plastic

For grouting ceramic, plastic ergonomic handle.

Available in different hardnesses of rubber for best finish as the joint width. Rubber float trowel, with white rubber sheet wear resistant. Solid rubber float, with hard rubber abrasion resistant. Thermoflex float, medium hardness.



FROM
£8.74
each

Code	Type	Price
65971	Rubber	£11.17
65973	Thermoflex Rubber	£8.74
65972	Solid Rubber	£9.90

Rubi Grout Floats PRO

For grouting ceramic tiles. Black foam rubber or White rubber sheet with wear resistance



FROM
£4.44
each

Code	Type	Price
10607	Foam Rubber	£8.48
24968	White Rubber	£4.44
24969		£5.43

Rubi Flexible Plaster Floats

30 x 14cm plaster floats. Flexible polyethylene and non-stick base



ONLY
£7.36
each

Code	Type	Price
71904	Plastic handle	£7.36

Rubi Spatulas

Wall tile grout spatula for filling joints.



FROM
£3.53
each

Code	cm	Price
65954	18	£3.53
65935	35	£4.19

Rubi Floor tile grout spatula

Reinforced spatula for professional jobs. Replaceable strip that can be used on both sides. Includes grip and aluminium holder.



ONLY
£28.13
each

Code	cm	Price
70905	60	£28.13

Rubi General purpose spatula

Adaptable to WOODEN HANDLE (Ref. 65450) Not included



FROM
£2.82
each

Code	cm	Price
65919	44	£2.82
70902	60	£3.28

Rubi Aluminium Handle

Suitable for use with floor tile grout spatula 50, 60 and 75 cm



ONLY
£9.14
each

Code	cm	Price
70904	-	£9.14

Rubi Wooden Handle

Holder for general purpose spatula of 44 cm. Ref. 65919 and 60cm. Ref. 70902



ONLY
£5.35
each

Code	cm	Price
65450	-	£5.35

Rubi Float plus 3 pads

To clean ceramic surfaces and other materials. Float with three different roughness replaceable pads; soft (red), medium (blue) and hard (brown).



ONLY
£14.72
each

Code	Type	Price
20900	mixed	£14.72
20944	very soft	£14.72

Rubi 3 pad replacement set

very soft (white), soft (red), medium (blue) hard (brown)



ONLY
£5.79
each

Code	Type	Price
20971	very soft	£5.79
20972	soft	£5.79
20973	medium	£5.79
20974	hard	£5.79
20902	soft/medium/hard	£5.79

Rubi Felt PRO float

To clean ceramic surfaces and other materials.



ONLY
£5.33
each

Code	Price
24975	£5.33

Sigma Wash Boy Sponge with Interchangeable Handle

Professional wash boy block cut sponge. Handle can be used with Sigma grout float base



ONLY
£5.75
each

Code	mm	Price
N4920008	300x140	£5.75

Rubi Sponge float SUPERPRO

Floats with SUPERPRO sponge for grout cleaning and finishing. PLUS models have extra cuts for extra cleaning power



FROM
£6.25
each

Code	Price
20924	Superpro £6.25
20908	Superpro Plus £7.70

Rubi Sprayer 0.19 gl. (0,75 cl.)

For easy application of cleaning and protection products.



ONLY
£3.50
each

Code	cl	Price
21911	75	£3.50

Nicobond Soft grip Float With Fixed Hydro Sponge

Float with soft grip handle and fixed hydro sponge



ONLY
£5
each

Code	mm	Price
N2540094	280 x 140	£5

Nicobond Soft grip Float With Replaceable Hydro Sponge

Float with soft grip handle & replaceable block cut hydro sponge



ONLY
£9
each

Code	mm	Price
N2540096	280 x 140	£9

Nicobond Replacement Hydro Sponge (For Prof Float)

Replacement Velcro block cut hydro sponge



ONLY
£4.50
each

Code	mm	Price
N2540098	280 x 140	£4.50

Nicobond Emulsifying Pad Handle Velcro

Cleaning pad handle with Velcro fixings for use with emulsifying pads



ONLY
£4.30
each

Code	mm	Price
N2540082	280 x 140	£4.30

Nicobond Emulsifying Pad

Cleaning pads for use with epoxy grouts in varying coarseness



ONLY
£1.65
each

Code	mm	Price
N2540084	Fine (White)	£1.65
N2540086	Medium (Brown)	£1.65
N2540088	Coarse (Black)	£1.65

Sponge float PRO

Polyurethane foam floats with high absorption. PLUS models have extra cuts for extra cleaning power



FROM
£4.64
each

Code	Price
24974	Sponge float PRO £4.64
24988	Sponge float PRO Plus £5.68

Rubi Float and replaceable sponge

Float sponges for cleaning and finishing tile and grout jobs. Interchangeable sponges for use with handle (ref 22912) Sponges available with different levels of absorption and resistance to abrasion. PLUS models have extra cuts for extra cleaning power



FROM
£4.55
each

	Code	Price	Trade
Float with replaceable SUPERPRO sponge	22900	n/a	£7.14
Float with replaceable SWEEPEX SUPERPRO sponge	22916	n/a	£8.15
Replaceable SUPERPRO sponge	22910	n/a	£4.55
Replaceable SUPERPRO sponge PLUS	22918	n/a	£4.87
Replaceable EPOXY CELLULOSE SUPERPRO sponge	22932	n/a	£13.98
Replaceable SWEEPEX SUPERPRO sponge	22922	n/a	£5.59
Replaceable SWEEPEX SUPERPRO sponge PLUS	22914	n/a	£6.16

Rubi Rubber foam float SOFT SUPERPRO float

For surface finishing and final cleaning. Ergonomic plastic handle.



FROM
£7.55
each

Code	cell size	Price
72985	big	£7.55
72986	medium	£8.04
72988	small	£8.88

Rubi Handle for interchangeable sponges and foams

Suitable for 30 x 13.5 cm and 34 x 17 cm SUPERPRO sponges and foam replacements.



ONLY
£3.29
each

Code	Price
22912	£3.29

Rubi Replacement rubber foam big cell SOFT-L SUPERPRO

Rubber foam sponges basis for finishing and final cleanings, adaptable to ergonomic handle (Ref. 22912) Available with different hardness and abrasiveness rubber-foam.



ONLY
£7.96
each

Code	Price
22924	£7.96

Rubi Replacement rubber foam small cell SOFT-S SUPERPRO

Rubber foam sponges basis for finishing and final cleanings, adaptable to ergonomic handle (Ref. 22912) Available with different hardness and abrasiveness rubber-foam.



ONLY
£9.12
each

Code	Price
22926	£9.12

Rubi COARSE rubber foam PRO float

For finishing and final cleaning of surfaces.



ONLY
£6.41
each

Code	cm	Price
24971	28x14	£6.41

Rubi FINE rubber foam PRO float

For finishing and final cleaning of surfaces.



ONLY
£7.66
each

Code	cm	Price
24973	28x14	£7.66

Rubi SWEEPEX SUPERPRO sponge with base for washboy

Large area reinforced base. Especially for use with PLUS RUBICLEAN SUPERPRO washboy. Handle included (Ref.70904). Polyurethane Sponge



FROM
£11.93
each

Code		Price
20914	-	£32.99
20919	replacement sponge	£11.93

Nicobond Washboy 23 Litre

Professional cleaning set for use with cement based grouts



ONLY
£25
each

Code	ltr	Price
N2540104	23	£25

Rubi RUBICLEAN TRIPLE SUPERPRO washboy

Plastic washboy, lightweight and high resistance. Equipped with 3 spiral rollers for further draining. Includes wheels and carrying handle. Useable capacity 10 litres. Dimensions: 20 7/8" x 11 1/32" x 14 9/16" (53 x 28 x 37 cm.)



ONLY
£41.69
each

Code	ltr	Price
21995	24	£41.69

Rubi RUBICLEAN SUPERPRO washboy

Plastic washboy, light and heavy duty, with two squeeze rollers and separation-decantation system of sewage. Includes wheels and carrying handle. Useable capacity 10 litres. Dimensions: 20 1/2" x 10 5/8" x 12" (52 x 27 x 30 cm.)



ONLY
£33.02
each

Code	Price	ltr
21998	£33.02	24

Rubi RUBICLEAN SUPERPRO 2 set

Consisting of: RUBICLEAN SUPERPRO washboy (Ref. 21998) Sponge float SUPERPRO (Ref. 20924) Thermoflex rubber grout float SUPERPRO (Ref. 65976)



ONLY
£48.66
each

Code	qty	Price
69915	set	£48.66

Rubi RUBICLEAN PRO washboy

Plastic washboy with two squeeze rollers. Wheels built into the base. Useable capacity 17 litres. Dimensions: 20 1/2" x 10 5/8" x 10 1/4" (52 x 27 x 26 cm.)



ONLY
£26
each

Code	ltr	Price
25949	24	£26

Rubi RUBICLEAN PRO 1 set

Consisting of: RUBICLEAN PRO washboy (Ref. 25949) Sponge float PRO (Ref. 24974) Grout float PRO 11"x5"x13/32" (28x14x1cm) (Ref. 24969)



ONLY
£33.32
each

Code	ltr	Price
68902	set	£33.32

Nicobond Tile Markers

Set of markers suitable for marking out tiles, glass, plastic, metal and paper



ONLY
£1.70
pack

Code	pack	Price
N2540276	2	£1.70

Rubi IRONBLADE measuring tape

Metal case with rubber coating to improve grip. Approved precision measuring tapes: Class II Automatic tape lock. (only available in mm).



FROM
£5.25
each

Code	m	Price
75904	5x19	£5.25
75905	8x25	£8.13
75909	5x25	£6.02

N&C Pro Tape Measure

Accurate, durable and ergonomic tape measure with metric and imperial scales, impact resistant case, spring return mechanism, 25mm wide tape and handy belt clip.



ONLY
£4.95
each

Code	m	Price
H9990185	5	£4.95

Rubi RUBIFLEX measuring tape

Ergonomic chassis made from plastic and rubber. Approved precision measuring tapes: Class II Magnetic tape stopper. (only available in mm).



FROM
£3.93
each

Code	m	Price
75901	5x19	£3.93
75902	8x25	£6.85

Rubi Rule support set

Rubi Rule support set

For easy adjustment and level ling of the rule for wall tiling. In box of 2 units.



FROM
£18.18
each

Code	cm	Price
60991	30	£18.18
60998	50	£20.08

Rubi Rule holder nail

Holds battens on walls, allowing a comfortable placement of tiles.



ONLY
£3.21
each

Code	cm	Price
72941	25	£3.21

Rubi Shape Template

Copies the shape of the areas which are a awkward to mark onto tiles, for subsequent cutting. Maximum depth 4.5cm



FROM
£16.26
each

Code	size	Price
70925	Regular	£16.26
72953	X-Large	£ 19.49

Rubi Master Line Marker

Ideal system to quickly draw straight lines between two points of the wall or floor. Supplied with a bottle of high quality powder for line marker.



ONLY
£15.62
each

Code	Price
70928	£15.62

Rubi "Master-N" Line Marker

Supplied with a bottle of high quality powder for line marker. Manufactured in plastic bimaterial (RUBIFLEX) high resistance to impact . Includes auxiliary level for levelling rope before tagging.



ONLY
£6.03
each

Code	m	Price
75925	30	£6.03

Rubi Line Marker with tracing powder

Ideal system to quickly draw straight lines between two points of the wall or floor. Supplied with a bottle of high quality powder for line marking.



ONLY
£9
each

Code	m	Price
70926	15	£9

Rubi Spare blue powder for line marker

Blue powder for filling the line marker.



ONLY
£10.04
each

Code	kg	Price
70929	1	£10.04

Rubi Construction pencil

Specially designed for writing on wet or glazed surfaces like ceramic tile, marble, granite, etc.

ONLY
£2.78
each



Code	each	Price
65942	1	£2.78

Rubi Carpenter pencil

For general use

ONLY
50p
each



Code	each	Price
65979	1	50p

Rubi Marking Tape

For marking construction areas. 200m roll

ONLY
£4.40
each



Code	mm	Price
70920	70 wide	£4.40

Rubi Line Reel Guide

With a core collector. 100m line

ONLY
£14.60
each



Code	mm	Price
70934	Ø1.5	£14.60

Rubi Line Reel

High resistance polyester cord. 50m line

ONLY
£2.50
each



Code	mm	Price
80933	Ø1.7	£2.50

Rubi Plumb Bob

Length of line:16,4 ft.(5 m).
Includes wooden dolly.

ONLY
£13.32
each



Code	g	Price
70964	600	£13.32

Rubi Plumb bob with magnetic dolly

Length of line:16,4 ft.(5m)
with magnet dolly.

ONLY
£16.41
each



Code	g	Price
70968	600	£16.41

Rubi Square

Square 1 5/8" x 13/16" (40x20mm) with high dimensional stability and bichromated treatment.

FROM
£22.81
each



Code	cm	Price
60993	60	£22.81
60994	80	£25.34

Nicobond Sealant Remover*

Soft grip dual action right angled blade allows both pull and push action for effective removal of cured silicone sealant

ONLY
£4.90
each



Code	Price
N2540228	£4.90

Nicobond Grout Rake

Grout remover with interchangeable carbide and saw blades

FROM
£2.50
each



Code	Price
N2540090	£4.90



Pack of 2 replacement blades for Nicobond professional Grout Rake

Code	pack	Price
N2540092	2	£2.50



Need technical support?

contact us at:
technical@nichollsandclarke.com

Rubi Rubiscraper

For grout removal without breaking the tile. Ideal for repair work (replacement of broken tiles) and refurbishment. 3 speeds. Stroke length 2mm. Blades for joints of 1.5 mm (ref. 66810, use only with speed 1) and 3 mm (ref. 66812) included. With transport case. Interchangeable blades for 1.5,2,3 and 4 mm joints.



ONLY
£110
each

Code	v	Hz	Price
66941	230	50 UK	£110

Rubi RUBISCRAPER blades

Replacement blades for use with Rubiscraper



FROM
£22
each

Code	mm	Price
66810	1.5	£22
66811	2	£24
66812	3	£24
66813	4	£27

Nicobond Hydro Sponge

Used for grouting and cleaning up grout.



FROM
£1.80
each

Code	mm	Price
N2540076	160x110x50	£1.80
N2540078	200x150x60	£3.00

Nicobond Square Cut Hydro Sponge

High quality hydro sponge with square cut edges for superior grout cleaning



ONLY
£2.50
each

Code	mm	Price
N2540079	160x110x62	£2.50

Nicobond Basic Sponge

Basic sponge for use when tiling



ONLY
82p
each

Code	mm	Price
N2540080	160x110x55	82p

Rubi Sponges

PLUS models have extra cuts for extra cleaning power.



Description	Code	Price
SUPERPRO sponge	20905	£1.46
SUPERPRO sponge PLUS	20917	£1.99
SWEEPEX SUPERPRO sponge	20928	£2.29
SWEEPEX SUPERPRO sponge PLUS	20932	£2.61
MIXED SUPERPRO sponge	20906	£2.41
MIXED SUPERPRO sponge PLUS	20918	£3.07
MIXED SWEEPEX SUPERPRO sponge special for joints	20992	£2.30
EPOXY CELLULOSE SUPERPRO sponge	22928	£4.76
MIXED EPOXY CELLULOSE SUPERPRO sponge	22929	£4.73
STANDARD PRO sponge	24966	£1.01
High absorption HYDRO PRO sponge	24967	£1.54

FROM
£1.01
each

Nicobond Trim Mitre Cutter

Designed for mitre cutting PVC trims and beading



ONLY
£12
each

Code	mm	Price
N2540001	-	£12

Nicobond Rod saw *

Ideal for cutting openings in ceramic tiles



ONLY
£6
each

Code	mm	Price
N2540002	152	£6

Nicobond Rod saw Replacement Blades *

Code	mm	Price
N2540004	152	£6

Nicobond Tile Scriber*

Tungsten carbide tipped scriber for manually scoring tiles prior to breaking

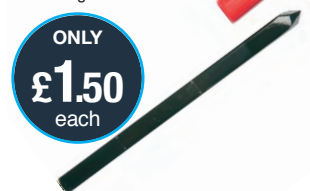

ONLY
£1.50
each

Code	mm	Price
N2540010	130	£1.50



Nicobond Mixing Paddle

Professional Speed mixing paddle for mixing grout, powder adhesive etc. Hexagonal steel handle will fit standard drills.



ONLY
£4.25
each

Code	mm	Price
N2540145	400 x 80	£4.25

Nicobond Soft Grip Tile Remover

Angled stainless steel blade with brass high impact end for the removal of wall and floor tiles



ONLY
£5.75
each

Code	Price
N2540198	£5.75

Nicobond Long Handled Floor Scraper

12" Long handle floor scraper.



ONLY
£30
each

Code	mm	Price
F0000028	300	£30
Long handle floor scraper blades		
Code	mm	Price
F0000029	300	£10

Nicobond Skeleton Gun

Solid metal frame sealant gun suitable for 310 and 400ml cartridges.



ONLY
£2.99
each

Code	ml	Price
N2540162	up to 400	£2.99

Nicobond Tile Magnets

Magnetic lock set for tile cover or access panels



ONLY
£7
each

Code	pack	Price
N2540142	4	£7

Nicobond Sealant Finisher

22mm and 35mm sized sealant finishes designed to achieve a great sealant finish, especially in hard to reach area. Such as behind taps



ONLY
£3
each

Code	pack	Price
N2540196	2	£3

Nicobond Cartridge Nozzle Stop

Plastic nozzle stop to prevent cartridge nozzles drying out.



ONLY
42p
each

Code	mm	Price
N2540270	165	42p

Nicobond Trim Mitre Block

Unique design mitre block for straight and mitre cutting of metal and PVC trim, with channels to hold the trim and an anti-slip base.



ONLY
£5.95
each

Code	mm	Price
N2540278	200 x 90	£5.95

Nicobond Tile Nipper

Soft grip tile nippers for shaping ceramic tiles



ONLY
£8.50
each

Code	Price	Trade
N2540007	one size	£8.50

Montolit Tile Nipper

Fixed wheel, angled head tile nipper for removal and shaping of porcelain, ceramic and glass tiles.



ONLY
£30
each

Code	Price
N4910022	one size £30

Rubi Carpenter's Pincer

For general use.



ONLY
£16.17
each

Code	mm	Price
71971	220	£16.17

Rubi Nippers for Porcelain Tiles

Specially for cutting narrow strips of a maximum of 1cm. C/w tungsten carbide scoring wheels with titanium surface treatment to last longer.



ONLY
£31.89
each

Code	mm	Price
83942	-	£31.89

Rubi Parrot nippers

Tungsten carbide edge of great hardness. To rectify holes on ceramics.



ONLY
£19.93
each

Code	Price
65925	£19.93

Rubi Nippers for hard materials

To rectify straight cuts on Porcelain Tiles and other hard materials.



ONLY
£20.16
each

Code	Price
65952	£20.16

Rubi Nippers for ceramic tiles

Tungsten carbide edge of great hardness. To rectify cuts of ceramics.



ONLY
£12.86
each

Code	Price
65926	£12.86

Rubi Nippers for glass mosaic

Tungsten Carbide edge of great hardness. To cut and rectify glass mosaic tiles.



ONLY
£23.96
each

Code	Price
71970	£23.96

Rubi Nippers for Porcelain Tiles

Specially designed nippers for cutting narrow strips of a maximum of 7/16" (1cm). Equipped with tungsten carbide scoring wheels with titanium surface treatment for longer useful life.

- Porcelain and ceramic



ONLY
£31.89
each

Code	Price
83942	£31.89

Rubi Parrot nippers

Tungsten carbide pliers, ideal for rectification of holes in ceramics.

- Ceramic



ONLY
£19.93
each

Code	Price
65925	£19.93

Rubi Nippers for hard materials

Specially for porcelain tiles, mosaic, vitrified tiles, and other materials.

- Porcelain and ceramic



ONLY
£20.16
each

Code	Price
65952	£20.16

Rubi Nippers for ceramic tiles

Tungsten carbide edge nippers for the rectification of straight cut on ceramics.

- Ceramic



ONLY
£12.86
each

Code	Price
65926	£12.86

Rubi Nippers for glass mosaic

Tungsten carbide edge nippers for the rectification of glass mosaic tiles.

- Glass



ONLY
£23.96
each

Code	Price
71970	£23.96

Rubi Foldable Work Table 4-In-1 (66924)

This versatile piece of equipment can be used in 4 ways. Work table – when assembled as a workbench, the 115x52cm work surface sits at a comfortable height of 80cm from the floor, perfect for a tile cutter to rest on. The top is flat MDF one side, used for working and an anti slip PP surface on the other, for when used as a step-up. Step-up – this offers the tile fixes a handy platform that can be used to reach ceiling height. Trolley – with the legs folded away, the 4 caster wheels on the base allows it to be used as a trolley for moving adhesive and tiles around. Creeper – this allows the tiles to lay on the trolley and be manoeuvrable on the floor, perfect for working under counters etc.

- Porcelain and ceramic

ONLY
£99
each

Code	mm	Price
N4900090	115x52	£99



N&C Mixing Bucket

Rigid mixing bucket for mixing powder adhesives, grouts and screeds. Tall narrow shape reduces dust escape and splatter. Convenient measuring points marked within the bucket side



ONLY
£4.99
each

Code	ltr	Price
N5579050	32	£4.99

Nicobond Flexible Bucket

Flexible bucket for mixing and carrying of adhesives, grouts and screeds



FROM
£3.99
each

Code	ltr	Price
N2540160	40	£6.49
N2540158	26	£4.99
N2540156	12	£3.99

Nicobond 3 Gallon Black Bucket

Heavy duty bucket with pouring spout and internal measurement guide



ONLY
£2.75
each

Code	ltr	Price
N2540152	15	£2.75

Rubi Braided rubber basket

Flexible. Ideal to carry with one hand. Polyamide reinforced with nylon fabric to increase tensile strength. At 30° C the tensile strength is 90 MPa, and elongation 45%. Handles great thickness. Increased resistance. Rounded geometry handles. More comfort.



ONLY
£5.84
each

Code	ltr	Price
88921	"espuerta" No. 2/11	£5.84

Rubi Rubber basket

4 handles. Ideal to be carried between 2 people or by mechanical lifting equipment. Reinforced with polyamide nylon weave to increase the tensile strength. At 30° C the critical load is 90 MPa, and elongation at break is 45%. Very thick handles.



FROM
£13.05
each

Code	ltr	Price
88924	"espuerta" 4 hdl no. 5 /37	£13.05
88928	"espuerta" 4 hdl no. 104 /85	£22.11

Rubi Rubber basket

Polyamide reinforced with nylon to increase tensile strength. At 30° C the tensile strength is 90 MPa, and elongation 45%. Handles very thick. Increased resistance.



ONLY
£14.57
each

Code	ltr	Price
88927	"espuerta" no. 103/60	£14.57

Rubi Rubber basket

Flexible bucket with extra thick handles for greater resistance and comfort.



FROM
£4.78
each

Code	ltr	Price
88937	"spart" No. 00/9	£4.78
88938	"spart" No. 000/12	£5.18
88900	"carbonera" no. 0/18	£7.08
88901	"carbonera" no. 1/26	£8.98
88902	"carbonera" no. 2/30	£9.15

Rubi Rubber basket

Large capacity. For mixing large amounts of cement or mortar. Reinforced with polyamide nylon weave to increase the tensile strength. Walls are reinforced with ribbing.



FROM
£19.29
each

Code	ltr	Price
88904	n°. 105/45	£19.29
88903	n°. 106/80	£22.19

Rubi Rubber tray

Flexible rubber tray with thick, rounded handles for greater resistance and comfort.



FROM
£5.83
each

Code	ltr	Price
88931	"gaveta" no. 1/8	£5.83
88932	"gaveta" no. 1'5/12	£7.17
88929	"gaveta" no. 2/14	£8.79

Rubi Rubber tray

Suitable for all types of construction industry professionals. With reinforced rim for greater resistance. Walls and base reinforced with ribbing.



FROM
£3.71
each

Code	ltr	Price
88570	no. 1/2	£3.71
88936	no.0/7	£ 5.26
88934	no. 3/28	£12.22
88935	no. 4/40	£17.64

Rubi Rubber bucket with graduation & spout

Embossed scale. With reinforced rim for greater resistance. Highly resistant metal handle. Greater wall thickness (14mm). Greater resistance. Walls are reinforced with ribbing.



FROM
£5.64
each

Code	ltr	Price
88912	no.4/10	£6.35
88913	no.50/10	£5.64

Rubi Rubber basket

Polyamide reinforced with nylon fabric to increase tensile strength. At 30° C the tensile strength is 90 MPa, and elongation 45%. Handles great thickness.



FROM
£5.32
each

Code	ltr	Price
88941	"espuerta" No.2/11	£5.32
88922	"espuerta" No. 2.5/20	£7.78
88804	"espuerta" No. 99/33	£8.00

Rubi Rubber bucket with spout

Embossed scale. With reinforced rim for greater resistance. Highly resistant metal handle. Greater wall thickness (14mm). Greater resistance. Walls are reinforced with ribbing.



ONLY
£6.75
each

Code	ltr	Price
88914	no. 51/12	£6.75

Rubi Industrial bucket

Embossed scale. With reinforced rim for greater resistance. Highly resistant metal handle. Greater wall thickness (14mm). Greater resistance. Walls are reinforced with ribbing.



ONLY
£7.29
each

Code	ltr	Price
88908	n° 52/12	£7.29

Rubi English rubber bucket

Embossed scale. With reinforced rim for greater resistance. Highly resistant metal handle. Greater wall thickness (14mm). Greater resistance. Walls are reinforced with ribbing.



ONLY
£8.20
each

Code	ltr	Price
88803	14	£8.20

Rubi Rubber bucket with graduation

Embossed scale. With reinforced rim for greater resistance. Highly resistant metal handle. Greater wall thickness (14mm).



ONLY
£7.71
each

Code	ltr	Price
88911	no.3/15	£7.71

Rubi Canarian rubber bucket with plastic handle

Embossed scale. With reinforced rim for greater resistance. Highly resistant metal handle. Greater wall thickness (14mm). Greater resistance. Walls are reinforced with ribbing.



ONLY
£6.35
each

Code	ltr	Price
88906	18	£6.35

Rubi "Italiano" rubber bucket

Greater comfort during transport. Easy waste collection. Heavy duty metal handle. Wall with reinforcing ribs.



ONLY
£5.50
each

Code	ltr	Price
88916	10	£5.50

Rubi Rubber bucket "italiano" with handle

Greater comfort during transport. For easy waste collection. Plastic handle grip. Greater comfort. Highly resistant metal handle. Walls are reinforced with ribbing.



ONLY
£5.50
each

Code	ltr	Price
88915	10	£5.50

Rubi Rubber bucket "italiano" with flat side & handle

Flat face. Greater comfort during transport. For easy waste collection. Plastic handle grip. Greater comfort. Highly resistant metal handle. Walls are reinforced with ribbing.



ONLY
£6.05
each

Code	ltr	Price
88940	10	£6.05

Rubi "Italiano" plastic bucket

Greater comfort during transport. For easy waste collection. Highly resistant metal handle. Walls are reinforced with ribbing.



ONLY
£3.52
each

Code	ltr	Price
88770	10	£3.52

Rubi Plastic bucket with graduation

Greater comfort during transport. For easy waste collection. Highly resistant metal handle. Walls are reinforced with ribbing.



ONLY
£3.50
each

Code	ltr	Price
88776	12	£3.50

Rubi Plastic bucket with graduation & spout

Greater comfort during transport. For easy waste collection. Highly resistant metal handle. Walls are reinforced with ribbing.



ONLY
£3.93
each

Code	ltr	Price
88775	15	£3.93

Rubi Plastic bucket model 2 with plastic handle

Greater comfort during transport. For easy waste collection. Highly resistant metal handle. Walls are reinforced with ribbing.



ONLY
£4.36
each

Code	ltr	Price
88772	20	£4.36

Rubi Heavy duty black plastic bucket

Greater comfort during transport. For easy waste collection. Reinforced handles. Greater resistance. Light.



ONLY
£4.36
each

Code	ltr	Price
88778	No.3/40	£4.36

Rubi Plastic tub N°. 1 / 25ltr

Greater comfort during transport. For easy waste collection. Reinforced handles. Greater resistance. Light.



FROM
£4.36
each

Code	Color	Price
88771	black	£4.36
88703	cream	£4.54
88706	red	£4.54
88700	yellow	£4.54
88701	blue	£4.54
88708	green	£4.54
88709	purple	£4.54
88707	pink	£4.54
88705	pistachio	£4.54
88704	orange	£4.54
88702	sky blue	£4.54
88710	mallow	£4.54

Rubi Plastic tub N°. 3 / 40tr

Greater comfort during transport. For easy waste collection. Reinforced handles. Greater resistance. Light.



FROM
£4.23
each

Code	Color	Price
88773	black	£4.23
88723	cream	£6.05
88726	red	£6.05
88720	yellow	£6.05
88721	blue	£6.05
88728	green	£6.05
88729	purple	£6.05
88727	pink	£6.05
88725	pistachio	£6.05
88724	orange	£6.05
88722	sky blue	£6.05
88730	mallow	£6.05

Rubi Plastic tub Black colour N°. 4 (55 l.)



ONLY
£5.32
each

Code	Price
88774	£5.32

Nicobond Knee Pads (Pair)

Heavy duty, foam core knee pads with Velcro straps & pressure clip to secure below the knee increasing stability & comfort



ONLY
£12.90
each

Code	Price
N2540146	£12.90

Recoil Knee Pads (Gen 2)

The Recoil Knee pads use a Spring Suspension system to protect your knees from the pressure of kneeling for hours on any surface



ONLY
£49.16
each

Code	Price
N2544000	£49.16

Sigma Knee Pads

Popular choice knee pads with all parts available as replacements



ONLY
£28
each

Code	Price
N4920009	£28

Rubi Professional knee pads

Made of absorbent material to protect against knocks and bumps. Its internal design is perfectly adaptable to the user's knee. Big leaning surface for optimum stability. Adjustable r fastener. Conforms to EN14404. Protection level: 0



ONLY
£17.36
each

Code	Price
65915	£17.36

Rubi FLEX knee pads

Adjustable elastic band fastener. Professional knee pads of high comfort. Inner body soft materials suitable to the user. Flexible and resistant outer shell. Conforms to EN14404. Protection level: 1



ONLY
£11.81
each

Code	Price
81994	£11.81

Rubi GEL DUPLEX knee pads

Design protects against impacts and uneven floors and soft materials adaptable to the user's anatomy. Protects the user's knees thanks to the silicone gel in the inside with great stability, preventing ligament and tendon fatigue. Conforms to EN14404. Protection level: 1



ONLY
£37.51
each

Code	Price
81989	£37.51

Rubi Gel Comfort knee pads

Ergonomic design professional and high comfort knee pads. They incorporate two bands Neoprene closure. Conforms to EN14404. Protection level: 1



ONLY
£22.62
each

Code	Price
81998	£22.62

Rubi SR-1 Ergonomic Seat

Aluminium chassis high strength and stability. Allows an ergonomic position of comfort. Prevents injuries in knees and back. Adjustable seat height and angle for optimum adaptation to each use. Robust construction with 7 heavy duty wheels. Includes tray for tools and accessories. Ideal for flooring, parquet installation, cleaning and other operations on pavements tasks. Replaceable ergonomic knee. Maximum weight: 286 lb. (130 kg.)



ONLY
£145
each

Code	Price
81999	£145

Rubi Knee cushion

Polyurethane cushion for protecting the knees. Makes it easy to work on the floor without using knee pads. Its wide surface allows its use as a seat.



ONLY
£23.01
each

Code	Price
65943	£23.01

Nicobond Rubber Mallet*

500gm white rubber mallet with 55mm Ø face for tile installation



ONLY
£7
each

Code	mm	Price
N2540140	55	£7

Rubi Black Rubber Mallet

Black rubber mallet. 2 flat sides. Suitable for tile fixing



FROM
£5.61
each

Code	g	Price
65904	250	£5.61
65905	500	£7.95
65908	750	£10.93

Rubi White Rubber Mallet

White rubber mallet. 2 flat sides. Suitable for tile fixing



FROM
£6.68
each

Code	g	Price
65912	250	£6.68
65913	500	£9.06
65914	750	£12.04

Rubi Black Rubber Mallet

One flat surface and the other spherical.



ONLY
£10.93
each

Code	g	Price
66910	750	£10.93

Rubi White Rubber Mallet

One flat surface and the other spherical.



FROM
£6.73
each

Code	g	Price
66905	250	£6.73
66906	500	£9.18
66907	750	£12.17

Rubi Single Suction Cup

Maximum load capacity 40kg



ONLY
£15.75
each

Code	swl kg	Price
65900	40	£15.75

Rubi Double Suction Cup

Body made of highly resistant aluminium. With ergonomic handle for greater comfort. Maximum load capacity 80kg



ONLY
£32.10
each

Code	swl kg	Price
66900	80	£32.10

Rubi Triple Suction Cup

Body made of highly resistant aluminium. With ergonomic handle for greater comfort. Maximum load capacity 100kg



ONLY
£46.96
each

Code	swl kg	Price
66904	100	£46.96

Nicobond Tile Spacers Peg Type

2mm peg type spacer for wall tiling.



ONLY
£2.60
each

Code	pack	Price
N2540110	500	£2.60

Nicobond Plastic Wedges 0-5mm 100 Per Pack

0-5mm plastic spacing wedges for use with tiles with irregular edges



ONLY
£2.60
each

Code	pack	Price
N2540108	100	£2.60

Nicobond Tile Spacers 2mm T Type

2mm T type spacers to create brick bond or staggered spacing for wall tiles



ONLY
£1.80
each

Code	pack	Price
N2540117	250	£1.80

Nicobond Tile Spacers Cross Type



FROM
£1.50
each

Nicobond Mosaic Wall Spacers

An innovative bedding out spacer system to ensure a flush surface finish for mosaics and tiles of different thicknesses. 5 sheets per pack that can achieve 2.5, 3.5, 4.5 and 5mm thicknesses

Code	mm	Price
N2540188	300 x 150	£8.50

1mm Cross type spacers for wall tiling

Code	pack	Price
N2540113	500	£1.50

2mm Cross type spacers for wall tiling

Code	pack	Price
N2540114	100	£1.08
N2540116	250	£1.60
N2540118	500	£3.00
N2540119	2500	£9.50
N2540120	5000	£17.50

3mm Cross type spacers for wall and floor tiling

Code	pack	Price
N2540122	250	£2.80
N2540124	500	£3.50
N2540126	5000	£27.50

4mm Cross type spacers for wall and floor tiling

Code	pack	Price
N2540128	250	£3.50
N2540130	3000	£30.00

5mm Cross type spacers for wall and floor tiling

Code	pack	Price
N2540132	100	£1.50
N2540134	3000*	£35.00



ONLY
£8.50
each

Nicobond Mosaic Backing Mesh

A self-adhesive 3mm backing that supports mosaic mesh sheets to enable fast & simple fixing with flat, square results every time.



ONLY
£1.50
each

Code	mm	Price
N2540269	300 x 300	£1.50

Genesis Roter Wedge

The simple design allows the installer to achieve a fully controlled level. They are the perfect choice when looking to support the bottom course when wall tiling.



ONLY
£1.80
each

Code	mm	pack	Price
508	1-13	100	£1.80

Genesis Multi-Height Reusable Spacer

Premium heavy duty re-usable multi height spacers, offering product longevity combined with versatility. This unique system covers the most popular sizes.

- Each leg size is easily identifiable
- Can be used in conjunction with levelling systems
- Supplied in a re-sealable bag
- Manufactured from high grade polypropylene
- 15mm leg length

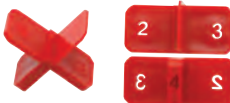

ONLY
£3.95
each

Code	mm	pack	Price
600	1,2,3,4 Cross Spacers	50	£3.95

Sigma Tiling Wedges

Plastic wedges from 0-5mm in size for tile fixing



ONLY
£3.08
each

Code	quantity	Price
N4920017	500	£3.08

Rubi Tile Spacers

For wall & floor tiles with minimum joint. Quality base material, without impurities or imperfections.



FROM
£2.15
each

Code	mm x qty	Price
2911	1 x 300	£2.15
2030	1 x 1000	£4.58
2912	1.5 x 300	£2.15
2031	1.5 x 1000	£4.58
2901	2 x 300	£2.15
2000	2 x 1000	£4.58
2952	2 (long) x 300	£2.42
2972	2 (long) x 1000	£6.46
2902	3 x 200	£2.15
2001	3 x 1000	£7.01

Rubi Tile Spacers

For large ceramic format and rectified. Quality base material, free from impurities and imperfections. Redesigned internal geometry. High flexural strength and crushing. Ideal for large format tiles in walls.



FROM
£2.42
each

Code	pack	Price
2953	3 (long) x 200	£2.42
2973	3 (long) x 1000	£9.05
2954	4 x 200	£2.48
2974	4 x 1000	£10.08

Rubi Tile Spacers

For floor tiles. Quality base material, without impurities or imperfections. Hollow structure with internal reinforcements. Supports the tensions and allows to leave into the joint and to grout over.



FROM
£2.15
each

Code	pack	Price
2903	5 x 100	£2.15
2002	5 x 1000	£12.76

Rubi Tile Spacers RIGID

Reinforced tile spacer specially for large format tiles. Quality base material , free from impurities and imperfections. Underside designed for a good settlement into the joint .



ONLY
£2.15
each

Code	pack	Price
2955	5 x 100	£2.15

Rubi Tile Spacers

For floor tiles. Quality base material, without impurities or imperfections. Hollow structure with internal reinforcements. Supports the tensions and allows to leave into the joint and to grout over.



FROM
£1.62
each

Code	pack	Price
2036	6 x 100	£2.31
2904	7 x 100	£2.48
2037	8 x 50	£1.62
2905	10 x 50	£2.35

Rubi T Spacers

Ideal for placement to "break joint" and perimeter . Quality base material without impurities or imperfections.



FROM
£2.32
each

Code	pack	Price
2859	1 x 300	£2.32
2862	1 x 1000	£6.47
2860	1.5 x 300	£2.32
2863	1.5 x 1000	£6.47
2861	2 x 300	£2.32
2864	2 x 1000	£6.47

Rubi T Spacers

Ideal for "brick style" tiling and perimeters. Quality base material, without impurities or imperfections.



FROM
£2.98
each

Code	pack	Price
2923	3 x 200	£2.98
2063	3 x 1000	£10.28
2924	5 x 100	£2.98
2925	7 x 100	£3.20
2926	10 x 100	£3.20

Rubi Wedges

Wedges for tiling. Quality base material, without impurities or imperfections.



FROM
£2.46
each

Code	pack	Price
2950	5 x 500	£4.92
2396	5 x 250	£2.46
2951	7.5 x 500	£5.15
2397	7.5 x 250	£2.58

Rubi TwinFlex® Spacers

For creating perfect placement joints in floor and walls. Manufactured in quality material. A colour for each model specific. Patented model.



FROM
£3.21
each

Code	pack	Price
2957	1.5/3 x 100	£3.21
2995	1.5/3 x 250	£10.13
2956	2/5 x 100	£3.21
2994	2/5 x 250	£10.13

Nicobond Clip & Wedge Tile Levelling System

1.5mm kit comprising of 200 clips and 100 wedges in a re-useable bucket



ONLY
£18.95
each

Code	mm	Price
N2541101	1.5	£18.95

Nicobond Clip & Wedge Tile Levelling System

3mm kit comprising of 200 clips and 100 wedges in a re-useable bucket



ONLY
£18.95
each

Code	mm	Price
N2541103	3	£18.95

Nicobond Clip & Wedge Tile Levelling System

Application tool for tightening system components



ONLY
£12.49
each

Code	Price
N2541104	£12.49

Nicobond Clip & Wedge Tile Levelling System

100 x 1.5mm clips in a bag



ONLY
£6.65
each

Code	mm	Price
N2541106	1.5	£6.65

Nicobond Clip & Wedge Tile Levelling System

300 x 1.5mm clips in a bucket



ONLY
£18.95
each

Code	mm	Price
N2541108	1.5	£18.95

Nicobond Clip & Wedge Tile Levelling System

100 x 3mm clips in a bag



ONLY
£6.65
each

Code	mm	Price
N2541112	3	£6.65

Nicobond Clip & Wedge Tile Levelling System

300 x 3mm clips in a bucket



ONLY
£18.95
each

Code	mm	Price
N2541114	3	£18.95

Nicobond Clip & Wedge Tile Levelling System

100 wedges in a bag



ONLY
£6.65
each

Code	Price
N2541118	£6.65

Nicobond Clip & Wedge Tile Levelling System

200 wedges in a bucket



ONLY
£18.95
each

Code	Price
N2541120	£18.95

Nicobond Adjustable Tile Levelling System

1.5mm kit comprising of 150 nuts, 150 cones and 150 bases in a re-useable bucket



ONLY
£39
each

Code	mm	Price
N2541150	1.5	£39

Nicobond Adjustable Tile Levelling System

500 x 1.5mm bases in a re-useable bucket



ONLY
£33
each

Code	mm	Price
N2541156	1.5	£33





- Improved accuracy and installation speed
- Traction adjustable Applicator
- Perfect for all types of tiles
- Maximum working depth 12mm
- Consistent grout lines (1, 2 or 3mm)
- Ideal for Walls and Floors

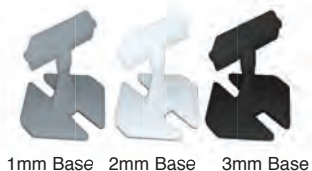

Code	Description	Qty	Price
639	1mm Base 100pcs per pack	40	£8.90
640	2mm Base 100pcs per pack	40	£8.90
641	3mm Base 100pcs per pack	40	£8.90
642	Starter Pack. Includes: 640, 644, 646		£39.50
644	Levelling Wedge 100pcs per pack	5	£11.50
646	Application Tool	24	£22.50



- Virtually eliminates lippage
- Dramatically reduces installation time
- Professional finish
- Consistent grout lines (1.2mm)
- Universally compatible base
- Maximum working depth 70mm
- Secure caps minimise movement
- Caps are reusable
- Large cap option for tiles over 60 x 60cm
- Installation tool for quicker application and removal
- Ideal for walls and floors

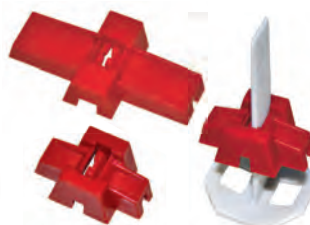

Code	Description	Box Price
664	Large Base - 200pk	6 £25
666	Large Cap - 100pk	6 £29
668	Small Cap - 100pk	6 £11
670	Application Tool	10 £19
675	G2 Adjustable Mounting Gun	10 £70
662	Starter Pack - 100 Universal Bases & Small Caps	6 £25

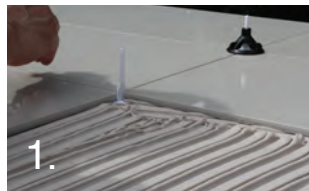

GLS Spin is an innovative tile levelling system allowing accelerated installation resulting from its auto-rotation mechanism using centripetal force.

- Flat base system
- Consistent grout line 2 or 3mm
- Maximum working depth 25mm
- Optional anti-friction plate
- Ideal for walls and floors
- Minimal effort
- No installation tools required



Code	Description	Qty	Price
610	Anti friction plates 100 pcs	6	£14
618	Spin caps 50 pcs	6	£15
622	2mm flat base 100 pcs	6	£11
623	3mm flat base 100 pcs	6	£12

**Rubi Levelling Systems
TILE LEVEL caps**

Can be reused up to 25 times.



FROM
£11.81
each

Code	Qty	Price
2980	100	£11.81
2947	400	£42.62

**Rubi Levelling Systems
TILE LEVEL strips**

For tiles between 3 and 20mm thick with a grout joint of at least 0,75mm



FROM
£14.17
each

Code	Qty	Price
2981	100	£14.17
2948	200	£26.92
2949	400	£51.15

**Rubi Levelling Systems
TILE LEVEL pliers**

For use with TILE LEVEL system.



ONLY
£24.42
each

Code	Price
2982	£24.42

**Rubi Levelling Systems
TILE LEVEL set**

The set consists of pliers
100 strips
100 reusable caps
Packaged in a bucket.



ONLY
£50.93
each

Code	Price
2992	£50.93

**Rubi Levelling Systems
TILE LEVEL CAPS**

Reusable caps. Made of POM. Its design ensures even distribution of the contact pressure.



FROM
£10.02
each

Code	Qty	Price
2890	100	£10.02
2891	200	£19.18
2892	400	£36.91

**Rubi Levelling Systems
TILE LEVEL Strip**

Made of technical polymer non-hygroscopic. The strip thickness guarantees minimum grout of 1 mm. Ensures continuous tension between strips and caps groove



FROM
£11.28
each

Code	Qty	Price
2893	100	£11.28
2894	200	£21.62
2895	400	£42.30

**Rubi Levelling Systems
TILE LEVEL QUICK Pliers**

Ergonomic design with bimaterial handle. Made of very light and resistant materials. Tighen regulation system depending on the thickness of the ceramic tile.



ONLY
£12.23
each

Code	Price
2989	£12.23

**Rubi Levelling Systems
Kit TILE LEVEL QUICK**

The set consists of pliers
100 strips
100 reusable caps.
Packaged in a bucket.



ONLY
£34.55
each

Code	Price
2941	£34.55

**Rubi Levelling Systems
DELTA LEVEL wedges**

Made from Polypropylene & can be re-used.

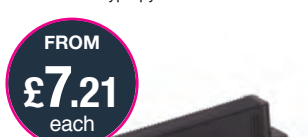

FROM
£7.21
each

Code	Qty	Price
02843	100	£7.21
02844	200	£13.95
02845	400	£25.54
02857	1200	£73.24

**Rubi Levelling Systems
DELTA LEVEL clips**

Made in PP. 1mm thick.
For tiles 3-12mm thick.



FROM
£5.58
each

Code	Qty	Price
02850	100	£5.58
02851	200	£10.70
02839	400	£20.54
02870	2400	£118.57

**Rubi Levelling Systems
DELTA LEVEL clips**

Made in PP. 1.5mm thick.
For tiles 3-12mm thick.



FROM
£5.58
each

Code	Qty	Price
02840	100	£5.58
02841	200	£10.70
02842	400	£20.54
02855	2400	£118.57

**Rubi Levelling Systems
DELTA LEVEL clips**

Made in PP. 2mm thick.
For tiles 3-12mm thick.

FROM
£5.58
each



Code	Qty	Price
02852	100	£5.58
02853	200	£10.70
02854	400	£20.54
02856	2400	£118.57

**Rubi Levelling Systems
DELTA LEVEL clips**

Made in PP. 3mm thick.
For tiles 6-15mm thick.

FROM
£6.20
each



Code	Qty	Price
02866	100	£6.20
02867	200	£12.09
02868	400	£20.92
02869	2400	£120.90

Ultragrim Pro Bio Huge Wipes

Super strong & soft cloth like fabric 38cm x 25 cm wipes. Removes grease, paint, silicone, uncured PU foam & adhesives. Stays wet & useable for over an hour!

ONLY
£12.50
each



Code	Qty	Price
D8013830	100	£12.50

Rubi Levelling Systems DELTA LEVEL pliers

Made of steel with ergonomic plastic handles. Protective sleeve on the clamp to avoid damaging the tile. 6 positions height adjustment according to the thickness of the ceramic tile.

ONLY
£19.20
each

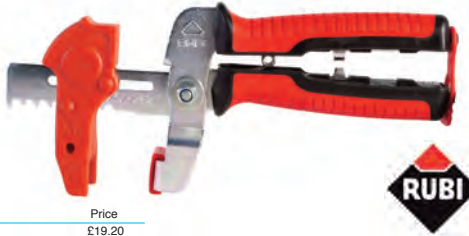

Code	Price
03901	£19.20

Nicobond Cotton Twill Dust Sheet

Contractors cotton twill dusk sheet 12'x 9'

ONLY
£7.50
each



Code	ft	Price
N2540154	12 x 9	7.50

**Rubi Levelling Systems
DELTA LEVEL set**

Set comprising
100 clips
100 wedges
pliers
plastic container

ONLY
£26.25
each



Code	Qty	Price
03913	1mm	£26.25
03914	1.5mm	£26.25
03915	2mm	£26.25

**Nicobond Self Adhesive
Carpet Protector
700mm X 25m**

ONLY
£15
each



Code	m	Price
N2540260	25 x 0.7	£15

**Rubi Levelling Systems
DELTA LEVEL clips**

Made in PP. 1.5mm thick.
For tiles 11-20mm thick.

ONLY
£6.58
each



Code	Qty	Price
02846	100	£6.58

**Rubi Levelling Systems
DELTA LEVEL clips**

Made in PP. 2mm thick.
For tiles 11-20mm thick.

ONLY
£6.58
each



Code	Qty	Price
02858	100	£6.58

**Nicobond Self Adhesive
Hard Floor Protector
700mm X 25m**

ONLY
£15
each



Code	ml	Price
N2540262	25 x 0.7	£15

Nicobond Zipper Door

Convenient door cover used to contain dust within one room while allowing access

ONLY
£16.50
each



Code	cm	Price
N5100030	220x112	£16.50

Nicobond Fire Retardant Protection Board

Manufactured from 2mm thick fluted polypropylene. Fully approved to LPS1207 with LCPB logo

ONLY
£4
each



Code	m	Price
N5100100	2.4 x 1.2 sheet	£4

Nicobond Standard Protection Board

Manufactured from 2mm thick fluted polypropylene, Nicobond Protection Board offers tough all round protection on the job site. Sheet or roll format

ONLY
£3
sheet



ONLY
£55
roll



Code	m	Price
N5100050	2.4 x 1.2 sheet	£3
N5100075	50 x 1 roll	£55

Nicobond Trade Tile Cleaner

Nicobond Tile Cleaner provides a gentle but powerful cleaning formula for all tile types.



ONLY
£6.50
each

Code	ltr	Price
N2540700	1	£6.50

Nicobond Trade Grout and Cement Remover

An acid based cleaner ideal for removing grout residues, building site dirt, efflorescence, rust stains & lime deposits.



ONLY
£6
each

Code	ltr	Price
N2540702	1	£6

Nicobond Trade Colour Intensifier and Sealer

A water based, high performance sealer and enhancer which brings out the natural colour of stone and leaves a high sheen to the surface.



ONLY
£30
each

Code	ltr	Price
N2540716	1	£30

Nicobond Trade Stain and Wax Remover

Nicobond Stain Remover is an advanced formula designed to remove wax deposits & unwanted stains from tiles.



ONLY
£7
each

Code	ltr	Price
N2540724	1	£7

Nicobond Trade Tile and Stone Polish

Nicobond Tile & Stone Polish will leave your tiles with a deep lustre.



ONLY
£12
each

Code	ltr	Price
N2540726	1	£12

Nicobond Trade Grout Protector

Nicobond Grout Protector protects grout from all types of stains and spills



FROM
£11
each

Code	ltr	Price
N2540720	0.5 Bottle	£11
N2540723	0.5 Aerosol	£13

Nicobond Trade Water Based Sealer

Nicobond Water Based Sealer provides maximum protection against stains and spills for your natural stone tiles.



ONLY
£14
each

Code	ltr	Price
N2540708	1	£14

Nicobond Trade Limescale Remover

Nicobond Limescale Remover is designed to remove lime scale and calcium deposits found on toilets, taps, tiles and sinks and kills germs.



ONLY
£6
each

Code	ltr	Price
N2540706	1	£6

Nicobond Trade Solvent Based Sealer

Nicobond Solvent Based Sealer provides maximum stain protection for polished surfaces while preserving the natural appearance of the tile.

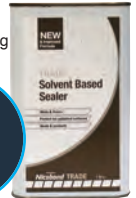

ONLY
£20
each

Code	ltr	Price
N2540712	1	£20

Nicobond Temporary Protection Sealer

A water based temporary protective sealer for tiles prior to grouting, which protects the surface from pigmented grouts.



ONLY
£14
each

Code	ltr	Price
N2540713	2.5	£14

Nicobond Floor & Wall Tile Cleaner

A gentle but powerful cleaning formula that will help maintain your tiles to their original state, without leaving any residues



ONLY
£5
each

Code	ltr	Price
N2540728	0.5	£5

Nicobond Floor and Tile Cleaner EXTRA

Our advanced acid based cleaner that is ideal for removing grout residues, stains lime, building site dirt rust & efflorescence's deposits.



ONLY
£5
each

Code	ltr	Price
N2540730	0.5	£5

Nicobond All-in-one Bathroom Cleaner

Perfect for frequent use to keep your bath, sink, toilet, shower and bathroom surfaces sparkling.



ONLY
£5
each

Code	ltr	Price
N2540732	0.5	£5

Nicobond All-in-one Bathroom Cleaner EXTRA

A powerful formula that removes limescale and calcium deposits found on toilets, taps, tiles and sinks, effectively cleaning and removing stains whilst killing germs.



ONLY
£6
each

Code	ltr	Price
N2540734	0.5	£6

Nicobond Stain Remover EXTRA

An advanced formula designed to remove wax deposits and unwanted stains from your tiles.



ONLY
£6
each

Code	ltr	Price
N2540760	0.5	£6

Nicobond Tile and Stone Polish

Polish is ideal for reviving your dull wall and floors and repolish traffic patterns, scratches, abrasions and surface stains to leave your tiles with a deep lustre finish.



ONLY
£7
each

Code	ltr	Price
N2540762	0.5	£7

Nicobond Grout Cleaner

Our fast acting, easy to use formula that will penetrate through dirt and residue to remove them quickly and effectively.



ONLY
£7
each

Code	ltr	Price
N2540754	0.5	£7

Nicobond Mould Remover

New powerful formula to efficiently and effectively remove mould stains from grout, plastic fittings, silicone sealant and enamel, and is ideal for use on plastic and enamel baths and showers.



ONLY
£4
each

Code	ltr	Price
N2540752	0.5	£4.

Nicobond Grout Protector Aerosol

Protects your grout from all types of stains and spill



ONLY
£13
each



Code	ltr	Price
N2540759	0.5	£13

Nicobond Grout Protector Capped Bottle

Protects your grout from all types of stains and spill



ONLY
£12
each

Code	ltr	Price
N2540756	0.5	£12

Nicobond Colour Enhancer and Sealer for Natural Product

Ideal for natural product is a water-based, high performance sealer and enhancer which brings out the natural colour of stone.



FROM
£22
each

Code	ltr	Price
N2540748	0.5	£22
N2540750	1	£34

Nicobond Invisible Sealer for Unpolished Natural Product

Seal and protect your unpolished natural stone tiles from stains & spills and enhance the appearance and durability through minimising water penetration



FROM
£9
each

Code	ltr	Price
N2540736	0.5	£9
N2540738	1	£15

Nicobond Invisible Sealer for Polished Natural Product

Nicobond Invisible Sealer provides maximum protection against stains & spills for your natural stone polished tiles.



FROM
£12
each

Code	ltr	Price
N2540740	0.5	£12
N2540742	1	£22

Nicobond Invisible Sealer for Polished Porcelain

Nicobond Invisible Sealer for Porcelain puts an invisible protection on your porcelain tiles, preserving their natural appearance.



FROM
£12
each

Code	ltr	Price
N2540744	0.5	£12
N2540746	1	£22

Nicobond Trade Sealers & Cleaners

Cleaning, Protection & Maintenance

	INITIAL CLEANING	PROTECTION		REGULAR CLEANING	SPECIAL CLEANING
		NATURAL LOOK PROTECTION	COLOUR ENHANCEMENT		
SLATE	Grout & Cement Remover	Water Based Sealer	Colour Intensifier & Sealer	Tile Cleaner	Stain & Wax Remover
UNPOLISHED NATURAL PRODUCTS	Grout & Cement Remover	Water Based Sealer	Colour Intensifier & Sealer	Tile Cleaner	Stain & Wax Remover
HONED NATURAL PRODUCTS	Grout & Cement Remover	Water Based Sealer	Colour Intensifier & Sealer	Tile Cleaner	Stain & Wax Remover
POLISHED NATURAL PRODUCTS	Tile Cleaner	Solvent Based Sealer	Colour Intensifier & Sealer	Tile Cleaner	Tile Cleaner
HONED APPLESTONE	Tile Cleaner	Water Based Sealer	Colour Intensifier & Sealer	Tile Cleaner	Stain & Wax Remover
LIMESTONE	Tile Cleaner	Water Based Sealer	Colour Intensifier & Sealer	Tile Cleaner	Stain & Wax Remover
GRANITE	Tile Cleaner	Solvent Based Sealer	Colour Intensifier & Sealer	Tile Cleaner	Tile Cleaner
POLISHED PORCELAIN	Grout & Cement Remover	Solvent Based Sealer	unrequired	Tile Cleaner	Stain & Wax Remover
RUSTIC PORCELAIN	Grout & Cement Remover	unrequired	unrequired	Tile Cleaner	Stain & Wax Remover
GROUT		Grout Protector	unrequired	Tile Cleaner	Grout Cleaner or Mould Remover

Nicobond Sealers & Cleaners Product Selector

Cleaning, Protection & Maintenance

	INITIAL CLEANING	PROTECTION		REGULAR CLEANING	SPECIAL CLEANING
		NATURAL LOOK PROTECTION	COLOUR ENHANCEMENT		
SLATE	Floor & Wall Tile Cleaner Extra	Invisible Sealer for Unpolished Natural Product	Colour Enhancer & Sealer for Natural Product	Floor & Wall Tile Cleaner / All in One Bathroom Cleaner	Stain Remover EXTRA
UNPOLISHED NATURAL PRODUCTS	Floor & Wall Tile Cleaner Extra	Invisible Sealer for Unpolished Natural Product	Colour Enhancer & Sealer for Natural Product	Floor & Wall Tile Cleaner / All in One Bathroom Cleaner	Stain Remover EXTRA
HONED NATURAL PRODUCTS	Floor & Wall Tile Cleaner Extra	Invisible Sealer for Unpolished Natural Product	Colour Enhancer & Sealer for Natural Product	Floor & Wall Tile Cleaner / All in One Bathroom Cleaner	Stain Remover EXTRA
POLISHED NATURAL PRODUCTS	Floor & Wall Tile Cleaner	Invisible Sealer for Polished Natural Product	Colour Enhancer & Sealer for Natural Product	Floor & Wall Tile Cleaner / All in One Bathroom Cleaner	Floor & Wall Tile Cleaner
HONED APPLESTONE	Floor & Wall Tile Cleaner	Invisible Sealer for Unpolished Natural Product	Colour Enhancer & Sealer for Natural Product	Floor & Wall Tile Cleaner / All in One Bathroom Cleaner	Stain Remover EXTRA
LIMESTONE	Floor & Wall Tile Cleaner	Invisible Sealer for Unpolished Natural Product	Colour Enhancer & Sealer for Natural Product	Floor & Wall Tile Cleaner / All in One Bathroom Cleaner	Stain Remover EXTRA
GRANITE	Floor & Wall Tile Cleaner	Invisible Sealer for Polished Natural Product	Colour Enhancer & Sealer for Natural Product	Floor & Wall Tile Cleaner / All in One Bathroom Cleaner	Floor & Wall Tile Cleaner
POLISHED PORCELAIN	Floor & Wall Tile Cleaner Extra	Invisible Sealer for Polished Porcelain	unrequired	Floor & Wall Tile Cleaner / All in One Bathroom Cleaner	Stain Remover EXTRA
RUSTIC PORCELAIN	Floor & Wall Tile Cleaner Extra	unrequired	unrequired	Floor & Wall Tile Cleaner / All in One Bathroom Cleaner	Stain Remover EXTRA
GROUT		Grout Protector	unrequired	Floor & Wall Tile Cleaner / All in One Bathroom Cleaner	Grout Cleaner or Mould Remover
CERAMIC	Floor & Wall Tile Cleaner Extra	unrequired	unrequired	Floor & Wall Tile Cleaner / All in One Bathroom Cleaner	All in One Bathroom Cleaner EXTRA / Stain Remover EXTRA

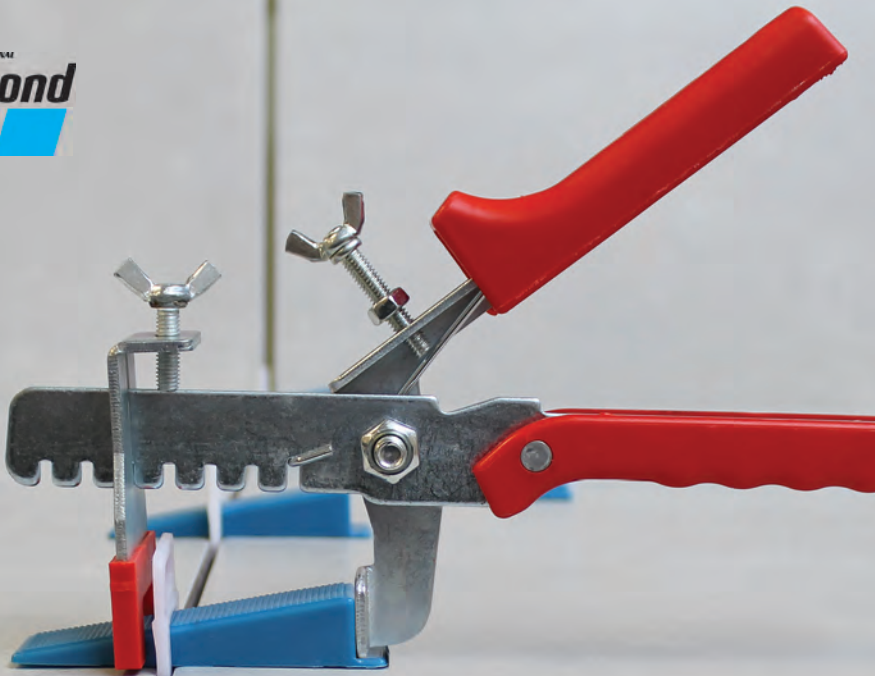

Nicobond Clip & Wedge Tile Levelling System Suitable for Wall and Floor Tile Fixing



Professionally tiled finish, every time

Tiling Solutions

for the Trade



**Nicobond
D-Mat 3L De-Coupling
Mat 30m² Roll
N5100495**



Only
£217.50
30m² roll

Nicobond D-Mat 3L De-Coupling Mat

For tiling onto cracked floors or green screed. Use Nicobond D-Mat 3L, for tiling on to problem substrates to avoid cracked tiles

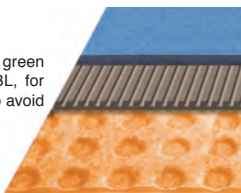

Nicobond D-Mat 3L Roll

Code	m	Price
N5100490	10 x 1	£80
N5100495	30 x 1	£217.50

FROM
£7.25
m²

Nicobond D-Mat 3L Cut Piece

Code	m ²	Price
N5100497	1	£9.99

Nicobond Disconnecting Sheet

For laying a temporary tiled floor in a rented or commercial property or for tiling over a contaminated floor.

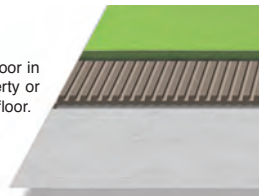

Nicobond Disconnecting Sheet Roll

Code	m	Price
N5000034	50 x 1	£199.99

FROM
£3.99
m²

Nicobond Disconnecting Sheet Cut Piece

Code	m ²	Price
N5000032	1	£4.40

Nicobond PlasticPly™

Reinforces timber floor boards and chipboard flooring and prevents floor tiles and grout from cracking when tiling onto a timber floor. 2mm thick

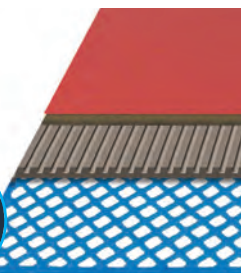

ONLY
£16.65
pack

Code	m ²	Price
N5100500	1.2	£16.65

Nicobond Acoustic Matting

Designed to reduce impact sound transmission through ceramic floor tiles on a concrete floor. 3mm thick

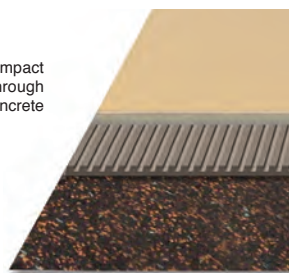

ONLY
£131
roll

Code	m	Price
N5100003	20 x 1	£131

Nicobond Wet Room Tanking Sheet

A tough sheet material designed to prevent water penetration on timber floors forms part of the Nicobond Wet Room Tanking System.



ONLY
£54.99
each

Code	m	Price
N5200110	10 x 0.75	£54.99

Nicobond Wet Room Self Adhesive Tanking Sheet

A highly flexible & robust self adhesive butyl rubber /polypropylene tanking sheet for effective waterproofing of walls and floors.



FROM
£149.99
each

Code	m	Price
N5200180	10 x 1	£174.99
N5200175	5 x 1	£149.99

Nicobond Wet Room Waterproof Tape

A strong 80mm wide self adhesive reinforcing tape for floor and wall joints, forms part of the Nicobond Wet Room Tanking System



ONLY
£39.16
each

Code	m	Price
N5200125	20	£39.16

Nicobond Wet Room Waterproof Corners

Pre-formed waterproof corners fabricated from neoprene waterproofing tape



ONLY
£5.82
each

Code	mm	Price
Internal N5200130	120 x 120	£5.82
External N5200140	120 x 120	£5.82

Nicobond Wet Room Waterproof Large Pipe Collar

Specially designed for sealing around large penetrating pipe work and drainage outlets. Forms part of the Nicobond Wet Room Tanking System



ONLY
£16.66
each

Code	mm	Price
N5200150	500 x 500	£16.66

Nicobond Wet Room Waterproof Small Pipe Collar

Specially designed for sealing around penetrating copper pipework and waste pipes. Forms part of the Nicobond Wet Room Tanking System



ONLY
£5.82
each

Code	mm	Price
N5200160	120 x 120	£5.82

Nicobond Wet Room Waterproofing Membrane

A quick drying, aqueous emulsion polymer based liquid applied waterproofing membrane for rigid surfaces in wet rooms, bathrooms and showers



ONLY
£58.32
each

Code	kg	Price
N5200100	8	£58.32

Nicobond Wet Room Waterproofing Tanking Kit

A convenient kit providing all necessary materials to waterproof a domestic shower area c/w 6kg of Waterproofing Membrane, 1200x750mm Tanking Sheet, 6m Waterproofing Tape & 1 Internal Corner Piece



ONLY
£66.66
each

Code	kit	Price
N5200000	kit	£66.66

Nicobond Wet Room Self Adhesive Tanking Kit

The Nicobond Self Adhesive Tanking Kit provides an excellent solution for quick and easy tanking in a wet room or shower environment. If tanking a wet room with a surface area in excess of 10m² then individual components may be purchased separately to complete the project.

Contains self adhesive wetroom tanking sheet, 4 x internal corners, 1 x external corner, 1 x tape and 1 ltr Nicobond Primer



FROM
£216.66
each

Code	m ²	Price
N5200200	10	£333.33
N5200185	5	£216.66

Nicobond Tile Backer Board & Construction Panel

A polystyrene hard foam core and coated with a glass-fibre mesh reinforced cement based mortar layer on both sides

- 87kg/m2 weight loading
- Insulating properties
- Class O fire rated
- High U value
- Improves undertile heating

FROM
£10.26
each

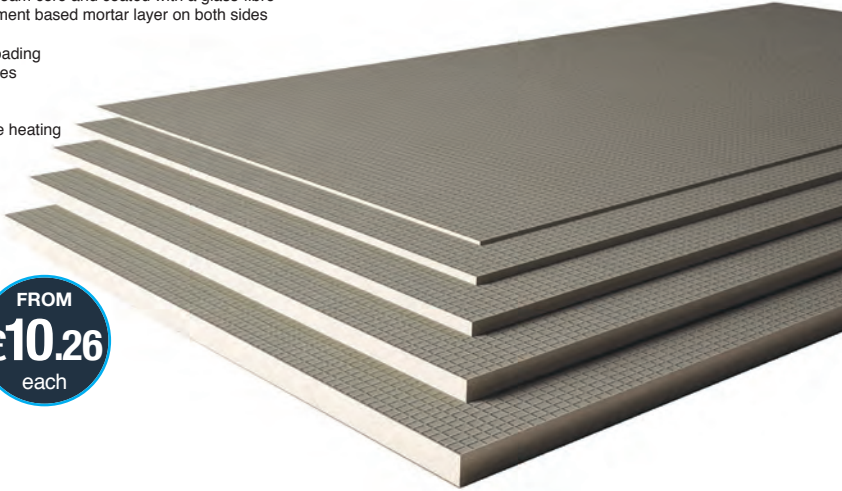

Code	m	Price
N2553006	1.2 x 0.6 x 6mm	£10.26
N2553010	1.2 x 0.6 x 10mm	£10.26
N2553013	1.2 x 0.6 x 12mm	£11.19
N2553021	1.2 x 0.6 x 20mm	£13.06
N2553030	2.4 x 0.6 x 30mm	£32.66

Code	m	Price
N2553040	2.4 x 0.6 x 40mm	£37.32
N2553050	2.4 x 0.6 x 50mm	£42.92
N2553060	2.4 x 0.6 x 60mm	£47.59
N2553070	2.4 x 0.6 x 70mm	£63.46
N2553084	2.4 x 1.2 x 12.5mm	£46.66

Nicobond Smooth Pipe Covers

The easy to fit pipe cover ready for immediate tiling or painting.
All sizes 2.4m long

FROM
£49.99
each

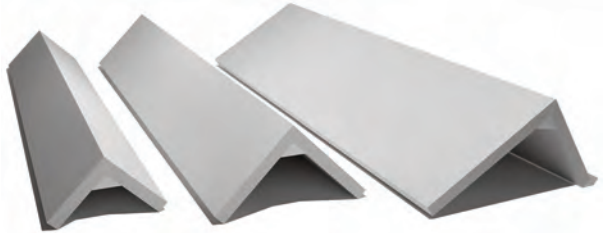

Code	mm	Price
N2553150	140 x 140*	£49.99
N2553200	200 x 200	£60.83
N2553240	200 x 300	£70.83

Nicobond Pre-Cut Construction Panel

Pre-slit construction panels for creating rounded shapes.
20mm thick.

ONLY
£33.59
each

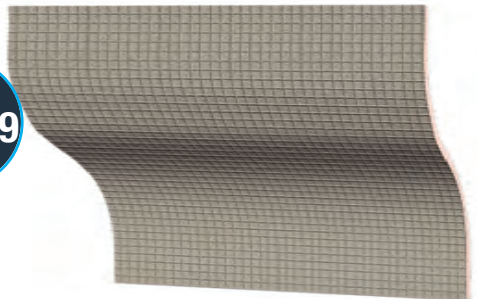

Code	m	Price
vertical slit		
N2553100	1.2 x 0.6 x 20mm	£33.59
horizontal slit		
N2553102	1.2 x 0.6 x 20mm	£35.59

Nicobond Waterproof Niche - Recessed Storage Unit

A pre-fabricated niche for fixing in-between the studs of timber frame walls. When used in conjunction with Nicobond Tile Backer Boards and Nicobond Waterproofing Self-adhesive Tapes, recessed storage spaces or "niches" can be created quickly and easily, resulting in a square, flat and professional look.



FROM
£49.99
each

Code	mm	Price
N2553400	250 x 340 x 120	£49.99
N2553402	350 x 340 x 120	£54.99
N2553404	450 x 340 x 120	£59.99

Nicobond Hammer Set Galvanised Backer Board Fixings

Use with Nicobond Tile Backer Board when dot and dab fixing to solid wall substrates.



FROM
£5.83
pack 10

Code	mm	Price
N2553108	80 x 8	£5.83
N2553109	110 x 8	£8.33

Nicobond Galvanised Screws & Washers

Pack of 50 specially designed 35mm dia washer with plasterboard screws, used for fixing Nicobond Backer Board into timber studs



FROM
£8.33
each

Code	mm	Price
N2553112	45	£9.99
N2553114	25	£8.33

Nicobond Galvanised Washers 35mm

Pack of 50 specially designed 35mm dia washers for use with Nicobond Backer Board



ONLY
£7.49
each

Code	mm	Price
N2553116	35	£7.49

Nicobond Jointing Tape

48mm wide self adhesive jointing tape for backer board edges.



ONLY
£6.99
each

Code	m	Price
N2552120	45	£6.99

N&C Wet Zone Base

The perfect solution to accommodate a shower drain when unable to breach the floor.

Our N&C Wet Zone is quickly and easily assembled using the N&C Premier Shower Deck mounted onto the Wet Zone Base. The principle benefit being that the components sit directly onto the floor. This offers the perfect solution where it is impossible or impractical to breach the floor. Waste pipes and connections are all built in to the base and previous connections can be utilised. A shower screen, tiles and shower valve complete the transformation.



FROM
£145.99
each



Code	mm	Price
N2561000	1000 x 1000 x 105	£145.99
N2561500	1500 x 800 x 105	£179.99

HardieBacker Board

Super strong cement fibre tile backer board from James Hardie. A water-resistant, no-mesh fibre cement board with Mouldblock™ technology. For kitchens, bathrooms and steam rooms.



FROM
£11.49
each

Code	mm	Price
N5001000	1.2 x 0.8 x 6mm	£11.49
N5001002	1.2 x 0.8 x 12mm	£12.49

HardieBacker Score and Snap Knife

Specially designed knife to quickly score and snap HardieBacker Board



ONLY
£8.99
each

Code	Price
N5001004	£8.99

HardieBacker HardieTape

Specially designed mesh tape to reinforce HardieBacker Board butt joints



ONLY
£6.30
each

Code	m	Price
N5001006	50 x 15mm	£6.30

ForgeFix ForgeFast Pozi Elite Wood Screws Box of 200

For fixing HardieBacker Boards. Recessed ribs provide improved countersinking. Patented thread for reduced splitting of timber, increased pull-out and a firmer fix. 'Elementech 400' coating provides an anti-corrosive finish lasting 6 times longer than zinc coatings.

ONLY
£6.49
each



Code	mm	Price
H1214913	4.0 x 25	£6.49
H1214915	4.0 x 35	£6.49

Achieve total confidence in wet room installations with...
N&C Premier Infinity Shower Deck



- Factory-fitted waste outlet that is impenetrable, watertight
- Unique, patented sliding drain that will avoid your joists
- An against-the-wall drainage system with tile insert
- Single plane fall to the waste, no envelope tile cutting

- 12mm upstands to meet tile backerboard / plasterboard
- Accepts upto 470kg loading.
- Strongest deck in the market*
- Available in all sizes from stock
- Fast & effective water clearance
- Tile directly to the shower deck
- Quick and easy to fit

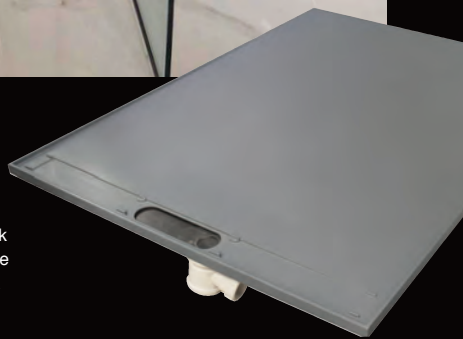

With threaded waste outlet 38mm



Slideable waste, up to 155mm, to avoid joists



Invisible drainage system

Stainless Steel Reversible Shower Shelf

- Premium model
- Grade 304 brushed finish
- 1.5mm wall thickness
- Unique reversible option
- Allows tile finish
- Integral bead to suit 9/11mm tile edge
- Tile-in

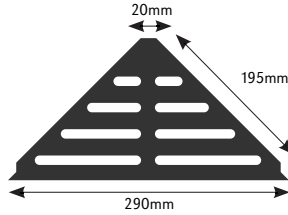

Code	Description	Qty	Price
KBREV	Stainless Steel Shower Shelf (Reversible)	1	£29.90

Stainless Steel Shower Shelf

Stylish shower shelf in brushed stainless steel. Fits in 90° corner. The shelf attaches in the grout joint with silicone - no drilling required!

Can be tiled in during installation or fitted retrospectively.

- 1.5mm thick
- No exposed sharp edge
- Brushed stainless steel finish
- Holes for drainage

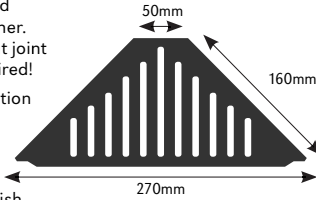

Code	Description	Qty	Price
KBSSS	Stainless Steel Shower Shelf	1	£14.90

Aluminium Steel Shower Shelf

Stylish shower shelf in aluminium. Fits in 90° corner. The shelf attaches in the grout joint with silicone - no drilling required!

Can be tiled in during installation or fitted retrospectively.

- 1.7mm thick
- No exposed sharp edge
- Aluminium finish
- Holes for drainage

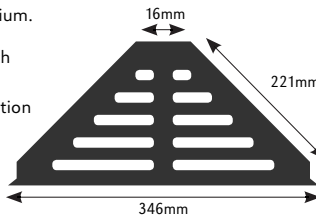

Code	Description	Qty	Price
KBSSA	Aluminium Shower Shelf	1	£25.97

All shower shelves are available with bespoke powder coating to any RAL on request

Surface Protector

Retrofit 3M self adhesive stainless steel surface protecting tiles.

Set contains 8 stainless steel heat resistant tactiles (25mm) and template.

Code	Description	Qty	Price
KBWPP8	25mm x 4mm Flat Top x 8 pcs	1	£49.80
KBWPP28	Worktop protector 280 x 16 x 3.5mm x 4 pcs	1	£115





Terra Level System

- Create outdoor tiled spaces in days not weeks
- Innovative, high quality, stable solution
- Long term laying of raised floors
- Use with 20mm porcelain tiles
- Available ex-stock nationwide
- Dry fit system
- Hide unsightly pipework underneath



Nicobond Terra Level Pressure Support Disc 3x200mm Pedestal System

(DVP) Part of the Nicobond Pedestal System for use with TL1 to distribute pressure or on it's own as a 3mm pedestal

ONLY
£2.24
each



Code	mm	Price
N2540412	3	£2.24

Nicobond Terra Level 1cm Stackable Tile Support (Pedestal System TL1)

Part of the Nicobond Pedestal System for 1 - 20cm heights

ONLY
£1.54
each



Code	mm	Price
N2540400	10	£1.54

Nicobond Terra Level 3cm Stackable Block (Pedestal System TL2)

Part of the Nicobond Pedestal System for over 5cm heights

ONLY
£1.76
each



Code	mm	Price
N2540402	30	£1.76

Nicobond Terra Level 1mm Stackable Adjusting Shim 500 Piece Bag (Pedestal System TL3)

Part of the Nicobond Pedestal System for 1mm adjustments

ONLY
£36.17
bag



Code	mm	Price
N2540404	1	£36.17

Nicobond Terra Level 6/ 13cm Stackable Adjustable Tile Support (Pedestal System TL4)

Part of the Nicobond Pedestal System for 6 - 52cm heights

ONLY
£6.20
each



Code	mm	Price
N2540406	60-130	£6.20

Nicobond Terra Level 7cm Coupler (Pedestal System TL4K)

Part of the Nicobond Pedestal System for use with TL4 to increase height in 7cm increments (Max 10 per stack)

ONLY
£3.05
each



Code	Size	Price
N2540407	70	£3.05

Wallbarn Metal Pedestal Paving Systems

Non-combustible, fully height adjustable, Class A1 pedestal specially designed for high-rise balconies, terraces and flat roofs. Manufactured from 100% class galvanized steel. Fully compliant to all fire safety regulations. 150mm diameter smooth circular baseplate. Millimetre precise height adjustment by twisting the solid telescopic threaded stem. Designed for suspended paving and tiling applications. Positioning lugs on headpiece support and separate corners of tiles allowing drainage between open joints. Suspended system, no mechanical fixings or adhesives required. Water runs between and beneath tiles to reduce surface ponding and slip hazards.

Zero plastic or rubber components, no interpretation. Complies with Approved Document B and British Standard BS 8579 and is rated as Class A1 Non-combustible to BS EN 13501-1.

Height range from 25mm to 300mm. Weight tolerance of over 1000kg per pedestal. Self-levelling headpiece up to 5% in all directions. Designed for purpose. Full metal solution.



Wallbarn Class A1 Fire Rated Paving Pedestals

FROM
£9.85
each



Code	mm	Price
N2540600	25-32	£9.85
N2540601	32-39	£10.05
N2540602	39-46	£10.10
N2540603	46-53	£10.20
N2540604	53-70	£14.00
N2540605	70-100	£14.50
N2540606	100-140	£14.90
N2540607	140-220	£16.50
N2540608	220-300	£17.50

Wallbarn Class A2-s1, d0 Fire Rated Decking Pedestals

FROM
£11.56
each

Code	mm	Price
N2540620	25-32	£11.56
N2540621	32-39	£11.75
N2540622	39-46	£11.94
N2540623	46-53	£12.19
N2540624	53-70	£16.87
N2540625	70-100	£17.49
N2540626	100-140	£18.82
N2540627	140-220	£19.44
N2540628	220-300	£21.96

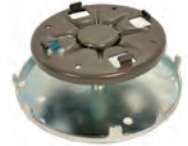

Wallbarn Class A Rail Substructure System

Non-combustible, fully adjustable, Class A2 substructure for non-combustible decking and tiling systems, specially designed for high-rise balconies, terraces and flat roofs.

Rail system designed to bring greater lateral stability to tiling applications. Specially designed, profiled ledged aluminium rail clicks onto powder coated headpiece of MetalPad without the need for mechanical fixings. Particularly suited to porcelain tiling projects.

Additional top paving headpiece clips onto upper surface of rail and can slide along to orientate the tile accurately. Four positioning lugs on the top headpiece position and separate the tiles with sufficient gaps for adequate drainage.

Height range from 45 to 320mm. Tiles are supported more fully across their edges; completely level upper surface and less risk of trip hazard. More luxurious finish.

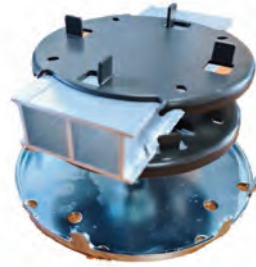

Wallbarn Class A Rail Substructure System with 20mm aluminium rail and top headpiece

Price per m² based on pedestals laid at 400x400 centres

mm	m2
45 - 52	£104.32
52 - 59	£105.65
59 - 66	£106.98
66 - 73	£108.73
73 - 90	£141.49
90 - 120	£145.83
120 - 160	£155.14
160 - 240	£159.48
240 - 320	£177.12

Wallbarn Class A Rail Substructure System with 20mm aluminium rail and top headpiece

Price per m² based on pedestals laid at 450x450 centres

mm	m2
45 - 52	£90.96
52 - 59	£92.10
59 - 66	£93.24
66 - 73	£94.74
73 - 90	£122.82
90 - 120	£126.54
120 - 160	£134.52
160 - 240	£138.24
240 - 320	£153.36

Wallbarn Class A Rail Substructure System with 20mm aluminium rail and top headpiece

Price per m² based on pedestals laid at 500x500 centres

mm	m2
45 - 52	£76.70
52 - 59	£77.65
59 - 66	£78.60
66 - 73	£79.85
73 - 90	£103.25
90 - 120	£106.35
120 - 160	£113.00
160 - 240	£116.10
240 - 320	£128.70

Wallbarn Class A Rail Substructure System with 20mm aluminium rail and top headpiece

Price per m² based on pedestals laid at 600x600 centres

mm	m2
45 - 52	£62.44
52 - 59	£63.20
59 - 66	£63.96
66 - 73	£64.96
73 - 90	£83.68
90 - 120	£86.16
120 - 160	£91.48
160 - 240	£93.96
240 - 320	£104.40

Pre-made, pipe covers ready for painting
or tiling directly onto. Simple.

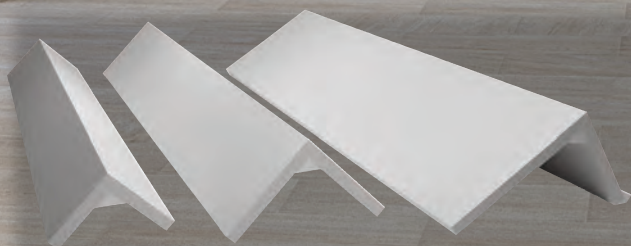

PROFESSIONAL
Nicobond

Perfect for soil stacks - Fit within minutes - Lightweight & easy to cut - Ready to tile / paint
Thermally insulated - waterproof & flame retardant - All lengths are 2400mm
Width availability - 140 x 140, 200 x 200 & 300 x 200mm

Tile Adhesives & Grouts *for the Trade*



**Ready Mixed
Tile Adhesive**



**PALLET
DEAL**
£8.99
when you purchase
44 buckets

Nicobond Waterproof Tile Adhesive

Flexible ready mixed adhesive for wall tiles in bathrooms and showers

- Walls
- Interior
- Non-Slip
- Flexible
- Water Resistant

**ONLY
£17.49**
each



Code	kg	Colour	Price
N1040001	15	White	£17.49

Nicobond Aquagrip

Flexible high grab ready mixed adhesive for wall tiles in bathrooms and showers.

- Walls
- Interior
- Non-Slip
- Flexible
- Water Resistant

**ONLY
£14.99**
each



Code	kg	Colour	Price
N1070001	15	White	£14.99

Nicobond Tile Adhesive

Ready mixed adhesive for fixing wall tiles
(Sold in Full Pallets of 44 Only)

- Walls
- Interior
- Non - Slip

ONLY
£8.99
Pallet



Code	kg	Colour	Price
N1010001	15	White	£8.99

Nicobond Ultragrip Adhesive

High grab ready mixed ceramic wall tile adhesive.

- Walls
- Interior
- Non-Slip

ONLY
£11.95
each



Code	kg	Colour	Price
N1030001	15	White	£11.95

Nicobond Rapidflex Fibre S2 Adhesive

A versatile rapid setting highly polymer modified & fibre reinforced adhesive for bonding porcelain, ceramic tiles and natural stones under difficult conditions including over green screeds.

- Walls
- Floors
- Interior
- Exterior
- Non-Slip
- Flexible
- Undertile Heating
- Water Resistant
- Swimming Pools

FROM
£29.98
each



Code	kg	Colour	Price
N1150350	20	Grey	£29.98
N1150550	20	White	£30.82

Nicobond Rapidflex S1 Adhesive

A fast setting, high performance, single part flexible and waterproof tile adhesive, bonds all types of tiles to a wide variety of substrates.

- Walls
- Floors
- Interior
- Exterior
- Non-Slip
- Flexible
- Undertile Heating
- Water Resistant
- 3 Hour Set
- Swimming Pools

FROM
£25.82
each



Code	kg	Colour	Price
N1150250	20	Grey	£25.82
N1150450	20	White	£26.65

Nicobond Large Format Flex S1 Adhesive

A fast setting flexible and pourable adhesive designed to be of fluid consistency to aid bedding of larger format tiles

- Walls
- Floors
- Interior
- Exterior
- Undertile Heating
- 3 Hour Set
- Water Resistant

FROM
£25.82
each



Code	kg	Colour	Price
N1150500	20	Grey	£25.82
N1150520	20	White	£26.65

Nicobond Flexible Fibre S1 Adhesive

A standard setting highly polymer modified and fibre reinforced adhesive with extended open time for bonding porcelain, ceramic, glass tiles and natural stone.

- Walls
- Floors
- Interior
- Exterior
- Non-Slip
- Flexible
- Undertile Heating
- Water Resistant
- 12 - 18 Hour Set
- Swimming Pools

FROM
£24.15
each



Code	kg	Colour	Price
N1190150	20	Grey	£24.15
N1190050	20	White	£24.98

Nicobond Quickflex Pro S1 Adhesive

A fast setting high performance and flexible tile adhesive, ideal for bonding porcelain, fully vitrified, ceramic tiles and mosaics

- Walls
- Floors
- Interior
- Exterior
- Non-Slip
- Water Resistant
- Swimming Pools

FROM
£16.65
each

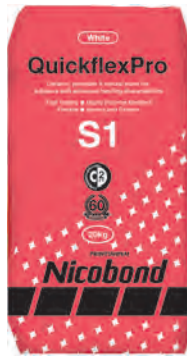

Code	kg	Colour	Price
N1150850	20	Grey	£16.65
N1150950	20	White	£17.48

Nicobond Standard Set Flex Pro S1 Adhesive

A standard setting high performance and flexible tile adhesive, ideal for bonding porcelain, fully vitrified, ceramic tiles and mosaics

- Walls
- Floors
- Interior
- Exterior
- Non-Slip
- Flexible
- Undertile Heating
- Water Resistant
- 18 - 24 Hour Set
- Swimming Pools

FROM
£16.65
each



Code	kg	Colour	Price
N1195050	20	Grey	£16.65
N1196050	20	White	£17.48

Nicobond Ecoflex S1 Adhesive

A fast setting, high performance, carbon neutral, single part highly flexible and waterproof tile adhesive, bonds all types of tiles to a wide variety of substrates.

- Walls
- Floors
- Interior
- Exterior
- Non-Slip
- Flexible
- Undertile Heating
- Water Resistant
- 3 Hour Set
- Swimming Pools
- Eco Friendly
- Recycle Materials

ONLY
£25.82
each



Code	kg	Colour	Price
N1306050	20	Natural Grey	£25.82

Nicobond Gypfix Adhesive

A rapid setting, whities gypsum based tile adhesive, specially designed for fixing ceramic, porcelain and natural stone to Anhydrite/ Calcium Sulphate floors.

- Floors
- Interior
- Undertile Heating
- 4 Hour Set

ONLY
£26.65
each



Code	kg	Colour	Price
N1162050	20	White	£26.65

Nicobond Rapid Tile & Stone Adhesive

A semi pourable, fast setting adhesive for solid floors

- Floors
- Interior
- Exterior
- Undertile Heating
- Water Resistant
- 2 - 3 Hour Set
- Swimming Pools

FROM
£19.99
each



Code	kg	Colour	Price
N1161250	20	Grey	£19.99
N1161350	20	White	£20.82

Nicobond Xtra Tile & Stone Adhesive

A standard setting, high build adhesive for natural stone, porcelain and ceramic tiles.

- Wall
- Floors
- Interior
- Exterior
- Undertile Heating
- Water Resistant
- 12 - 24 Hour Set
- Swimming Pools

FROM
£22.49
each



Code	kg	Colour	Price
N1150150	20	Grey	£22.49
N1150050	20	White	£23.32

Nicobond Quickflex Adhesive

A quick setting, thin or thick bed flexible tile adhesive for porcelain and ceramic tiles

- Wall
- Floors
- Interior
- Exterior
- Non-Slip
- Undertile Heating
- Water Resistant
- 3 Hour Set
- Swimming Pools

FROM
£14.99
each



Code	kg	Colour	Price
N1150650	20	Grey	£14.99
N1150750	20	White	£15.40

Nicobond Standard Set Flex Adhesive

A single part, standard setting, waterproof, flexible adhesive for fixing ceramic wall & floor tiles, porcelain, mosaic & natural stone where a resilient bond is required.

- Wall
- Floors
- Interior
- Exterior
- Non-Slip
- Undertile Heating
- Water Resistant
- Swimming Pools

FROM
£14.99
each



Code	kg	Colour	Price
N1193050	20	Grey	£14.99
N1194050	20	White	£15.40

Nicobond Quickfix Adhesive

A quick setting thin or thick bed tile adhesive, suitable for ceramic wall and floor tiles, terracotta and quarry tiles.

- Wall
- Floors
- Interior
- Exterior
- Non-Slip
- Water Resistant
- 3 Hour Set

ONLY
£9.99
each



Code	kg	Colour	Price
N1161150	20	Grey	£9.99



Nicobond Nico-lastic Adhesive

A highly versatile, two part epoxy polyurethane adhesive for bonding tiles to a variety of substrates.

- Wall
- Floors
- Interior
- Exterior
- Non-Slip
- Undertile Heating
- Flexible
- Water Resistant
- Swimming Pools
- Chemical Resistant

ONLY
£54.99
each



Code	kg	Colour	Price
N1337660	5	Beige	£54.99

Nicobond Starlike evo Extreme Performance Grout

Nicobond Starlike is an easy to use extreme performance grout that can also be used as a mortar. Offers superb and acid resistance with long term durability for the toughest of jobs. Easy to wipe clean.

Add Special fx to create a unique finish:

- Glitters (see below)
- 5 Metallic colours
- 6 Crystal option
- 18 Luminous Night Visions

Please note: Not all Special fx finishes are available in every colour.

FROM
£44.98
each



Standard stocked colours nationwide

Slate Grey	Mid Grey	Silver Grey	White
------------	----------	-------------	-------

Code	kg	Colour	Price
N1335660	2.5	Slate Grey 125	£44.98
N1336060	2.5	Mid Grey 110	£44.98
N1335560	2.5	Silver Grey 105	£44.98
N1335260	2.5	White 100	£44.98



Starlike evo cool colours

	STANDARD	GALAXY	SILVER	GOLD
N1335260 2.5kg White 100	£44.98			
N1341000 2.5kg Pearl 102	£44.98			
N1335560 2.5kg Silver Grey 105	£44.98			
N1336060 2.5kg Mid Grey 110	£44.98			
N1341000v 2.5kg Pearl 102 ▲	£44.98			
N1341002 2.5kg Lead 120▲	£44.98			
N1335660 2.5kg Slate Grey 125	£44.98			
N1340003 2.5kg Concrete 130	£44.98			
N1340004 2.5kg Anthracite 140	£44.98			
N1335460 2.5kg Black 145	£44.98			

Starlike evo warm colours

	STANDARD	GALAXY	SILVER	GOLD
N1335160 2.5kg Jasmine 200	£44.98			
N1336160 2.5kg Cream 202	£44.98			
N1340005 2.5kg Honey 205▲	£44.98			
N1340006 2.5kg Sand 208▲	£44.98			
N1336260 2.5kg Limestone 210▲	£44.98			
N1340007 2.5kg Taupe 215▲	£44.98			
N1334660 2.5kg Cappuccino 225▲	£44.98			
N1335060 2.5kg Coffee 230	£44.98			
N1340008 2.5kg Leather 232	£44.98			
N1340009 2.5kg Espresso 235	£44.98			

Starlike evo vibrant colours

	STANDARD	GALAXY	SILVER	GOLD
N1340010 2.5kg Pastel Blue 300	£48.98			
N1340011 2.5kg Powder Blue 310▲	£48.98			
N1340012 2.5kg Caribbean Blue 320 ▲	£48.98			
N1340013 2.5kg Sky 330▲	£48.98			
N1340014 2.5kg Denim 340▲	£48.98			
N1340015 2.5kg Sapphire Blue 350▲	£48.98			
N1340016 2.5kg Mint 400	£48.98			
N1340017 2.5kg Emerald 410▲	£48.98			

	STANDARD	GALAXY	SILVER	GOLD
N1340018 2.5kg Grass 420▲	£48.98			
N1340019 2.5kg Pine Green 430▲	£48.98			
N1340020 2.5kg Powder Pink 500▲	£48.98			
N1340021 2.5kg Purple Amethyst 530 ▲	£48.98			
N1340022 2.5kg Oriental Red 550	£48.98			
N1340023 2.5kg Brick Red 580	£48.98			
N1340024 2.5kg Lemon 600▲	£48.98			

Please see page 87 for prices on galaxy, silver, gold and other special fx
Available from UK stocks ▲ Can be used with Night Vision

Nicobond Starlike special fx

Nicobond special fx Sparkle, a range of glitter additives which combine with Starlike evo Grout and Super Grout Pro to produce a unique and attractive sparkle effect to the grout. See individual products for details

Code	Colour	Price
N1335860	75g Galaxy Glitter	£17.65
N1335760	75g Silver Glitter	£17.65
N1335865	75g Gold Glitter	£26.05
N1336560	2.5kg Crystal 700	£49.98
N1340030	2.5kg 800 Nordic	£49.98
N1340031	2.5kg 810 Peppermint	£49.98
N1340032	2.5kg 820 Ice blue	£49.98
N1340033	2.5kg 825 Frappe	£49.98
N1340034	2.5kg 830 Winter Rose	£49.98



Metallics Range		
N1336660	2.5kg Neutro 113	£44.98
N1340025	100g Platinum	£30.82
N1335866	100g Gold	£30.82
N1340026	100g Copper	£30.82
N1340027	100g Rust	£30.82
N1340028	100g Bronze	£30.82
N1340029	200g Night Vision	£30.82

Nicobond Super Grout Pro

Superior fast track grouting, ready mixed, highly flexible & stain resistant polyurethane formulation in a re-sealable tub

- Extremely easy to use
- Fast track grouting
- Up to 6mm joint widths
- Use with ceramic, porcelain & mosaic
- Use with wall and floor tiles
- Stain resistant
- Highly flexible
- Keep unused material for future use
- Water repellent
- Very low CO2 / VOC emissions
- Available in 8 cool and warm colours
- Add special FX Glitter and Gold Sparkle
- Ideal for kitchens & bathrooms
- Use on non-rigid substrates (timber floors)



Code	kg	Colour	Price
N1291032	5	Anthracite	£58.25
N1291022	5	Slate Grey	£58.25
N1291012	5	Mid Grey	£58.25
N1291002	5	White	£58.25
N1291042	5	Limestone	£58.25
N1291052	5	Honey	£58.25
N1291062	5	Cappuccino	£58.25
N1291072	5	Coffee	£58.25

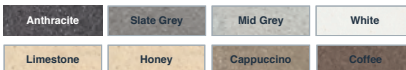

Nicobond Starlike evo Resin Cleaner

A concentrated liquid detergent for effective removal of Starlike evo Grout haze from tiled surfaces.



ONLY
£20.49
each

Code	ltr	Colour	Price
N1335960	1	Clear	£20.49

Nicobond Starlike evo Resin Remover

A high performance liquid gel detergent for the removal of stubborn epoxy streaks from tiled surfaces.



ONLY
£23.40
each

Code	ml	Colour	Price
N1335965	500	Clear	£23.40

Nicobond Super Grout Pro Cleaner

An eco-friendly liquid detergent designed for the safe and effective removal of Nicobond Super Grout Pro residues from the surface of tiles.



ONLY
£19.99
each

Code	ml	Colour	Price
N1290000	750	Clear	£19.99

Nicobond GroutPro Flexible

A highly polymer modified and highly flexible grout which is efflorescence free, anti mould, excellent water repellence and market leading handling characteristics.

- Market leading handling characteristics
- Highly polymer modified
- Flexible - for use over timber floors
- Use with underfloor heating systems
- Fast setting
- Efflorescence free
- Aquablok technology high water resistance
- Internal and external use
- Available in 12 popular colours
- 12 coordinating silicone sealants available
- Joint width: 2 - 20mm
- Pot Life: Approx 45-60 mins
- Setting Time: Approx 3 hours
- Ready for use: 8 - 12 hours
- Available in: 10, 2.5kg



COOLS		WARMS	
	White		Jasmine
	Silver Grey		Cream
	Mid Grey		Limestone
	Slate Grey		Honey
	Anthracite		Cappuccino
	Black		Coffee

Code	kg	Colour	Price	Code	kg	Colour	Price
N1320001	10	White	£33.32	N1320061	10	Jasmine	£33.32
N1320003	2.5	White	£13.50	N1320063	2.5	Jasmine	£13.50
N1320011	10	Silver Grey	£33.32	N1320071	10	Cream	£33.32
N1320013	2.5	Silver Grey	£13.50	N1320073	2.5	Cream	£13.50
N1320021	10	Mid Grey	£33.32	N1320081	10	Limestone	£33.32
N1320023	2.5	Mid Grey	£13.50	N1320083	2.5	Limestone	£13.50
N1320031	10	Slate Grey	£33.32	N1320091	10	Honey	£33.32
N1320033	2.5	Slate Grey	£13.50	N1320093	2.5	Honey	£13.50
N1320041	10	Anthracite	£33.32	N1320101	10	Cappuccino	£33.32
N1320043	2.5	Anthracite	£13.50	N1320103	2.5	Cappuccino	£13.50
N1320051	10	Black	£33.32	N1320111	10	Coffee	£33.32
N1320053	2.5	Black	£13.50	N1320113	2.5	Coffee	£13.50

12 co-ordinating Silicone Sealants also available

Nicobond Floor Tile Grout

A mid Grey highly polymer modified, fast setting, abrasion and water resistant floor grout which is efflorescence free and has excellent anti mould properties.

- Market leading handling characteristics
- Highly polymer modified
- High abrasion resistance
- Suitable for commercial environments
- Flexible - for use over timber floors
- Use with under tile and under floor heating
- Fast setting – accepts foot traffic in 6 hours
- Efflorescence free
- Aquablok technology high water resistance
- Internal and external use
- Joint Width 3-15mm
- Pot Life: Approx 45-60 mins
- Setting Time: Approx 3 hours
- Ready for use: 6 hours



FROM
£21.24
each



Code	kg	Colour	Price
N1373050	20	Mid Grey	£31.65
N1373051	10	Mid Grey	£21.24

Nicobond Tilers Grout

A brilliant white water resistant grout for ceramic wall and floor tiles, mosaic and marble. Each 20kg bag holds 8 x 2.5kg polybags for super convenience

- Ultra-fine finish
- Water resistant
- Interior or exterior Use
- Ceramic wall & floor tiles, mosaics & natural stones
- Joint width – up to 4mm
- Pot life: approx 60 mins
- Setting time: 18-24 Hours
- Ready for use: 24 hours
- 20kg bag contains 8x2.5kg poly bags



Code	kg	Colour	Price
N1300050	20	White	£24.98
N1300051	10	White	£14.57
N1300052	5	White	£10.58
N1300053	2.5	White	£6.61



Fast forward to modern day grouting



The ultimate, superior ready mixed, re-sealable professional grouting compound

Nicobond Render Improver

A high solids content SBR additive for use in cement :sand renders and mortars

FROM
£33.07
each

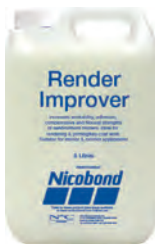

Code	ltr	Colour	Price
N1910008	25	White	£129.32
N1910003	5	White	£33.07

Nicobond PVA Bonding Agent & Sealer

A high quality multipurpose PVA bonding agent

FROM
£6.81
each



Dries To Clear

Code	ltr	Colour	Price
N1760003	5	Clear	£19.43
N1760506	1	Clear	£6.81

Nicobond Primer

An acrylic dispersion used from priming sand/cement screeds, concrete or render prior to applying Nicobond flooring or tiling products.

FROM
£10.58
each



Code	ltr	Colour	Price
N1460003	5	White	£33.10
N1460006	1	White	£10.58

Nicobond Enhancer 2002

A highly modified acrylic resin emulsion which improves the properties of Nicobond cementitious adhesives and grouts under demanding conditions.

FROM
£11.46
each



Code	ltr	Colour	Price
N1440004	4	White	£37.08
N1440006	1	White	£11.46

Nicobond Fill-It

A fast drying flexible acrylic decorators filler and sealant which can be over painted with all paint types. Contains a powerful anti-fungicide to prevent mould growth. No sanding down is required. Can be used externally.

ONLY
£2.64
each



Code	ml	Colour	Price
N1741100	380	White	£2.64

Nicobond Stick-It

High performance gap filling panel adhesive.

ONLY
£3.92
each



Code	ml	Price
N1740000	310	£3.92

Nicobond MS Pro

A general purpose, solvent free, polymer modified adhesive and sealant.

ONLY
£10.58
each



Code	ml	Colour	Price
N1741002	290	White	£10.58
N1741004	290	Clear	£10.58

Nicobond Silicone Sealant

A high quality silicone sealant for sealing around wash basins, bath surrounds and showers.

ONLY
£7.06
each



Code	kg	Colour	Price
N1720015	310	White	£7.06
N1720515	310	Clear	£7.06

Nicobond Neutral Cure Silicone Sealant

A high quality low modulus neutral cure silicone sealant, ideal for sealing round natural stone and ceramics, coordinating colours to Grout Pro Flexible. Wide ranging applications in bathrooms, showers and kitchens.

ONLY
£10.34
each

Code	kg	Colour	Price
N1730055	310	Silver Grey	£10.34
N1730045	310	Mid Grey	£10.34
N1730035	310	Slate Grey	£10.34
N1730025	310	Anthracite	£10.34
N1730015	310	Black	£10.34
N1730065	310	Jasmine	£10.34
N1730075	310	Cream	£10.34
N1730085	310	Limestone	£10.34
N1730095	310	Honey	£10.34
N1730105	310	Cappuccino	£10.34
N1730115	310	Coffee	£10.34





Starlike *evo*

Extreme Performance Grout

Extreme professional grout with exceptional handling,

Tile Trims & Profiles

for the Trade



Genesis

**Genesis PVC Regular Trim White 6mm
N3020001**



BOX
PRICE ONLY

99p

each

Genesis PVC Regular Trim

Features a smart quadrant face for 3 dimensional alignment, overhang lips to better butt against the cushion edge of the ceramic tile, and a second upright to support the face making. All versions available in 2.5m lengths



FROM
99p
each

Code	mm	Colour	Code	Price	Box Price	Box Qty
N3020001	6	White	ETR608.01	£3.32	£0.99	100
N3024001	7	White	ETR708.01	£3.32	£1.15	60
N3025001	8	White	ETR808.01	£3.32	£1.15	60
N3035001	9	White	ETP908.01	£3.32	£1.70	50
N3026001	10	White	ETR108.01	£3.32	£1.35	60
N3026100	12	White	ETR128.01	£3.32	£1.45	60
N3020034	6	Soft Cream	ETR608.32	£5.33	£1.25	100
N3025034	8	Soft Cream	ETR808.32	£5.33	£1.35	60
N3026005	10	Soft Cream	ETR108.32	£5.33	£1.45	60
N3026101	12	Soft Cream	ETR128.32	£5.33	£1.60	60
N3020003	6	Grey	ETR608.11	£5.33	£1.25	100
N3025003	8	Grey	ETR808.11	£5.33	£1.35	60
N3026003	10	Grey	ETR108.11	£5.33	£1.45	60
N3020007	6	Black	ETR608.16	£5.33	£1.25	100
N3025007	8	Black	ETR808.16	£5.33	£1.35	60
N3026009	10	Black	ETR108.16	£5.33	£1.45	60

Genesis PVC Regular Trim Corner Pieces

Injection Moulded corner pieces to complement the profile eliminating the need for mitring - for the perfect finish. Available in packs of 100 pieces



From
£5.49
each

Code	mm	Colour	Code	Price	Box Price	Box Qty
N3020045	6 x 6	White	PDM603.01	£10.99	£5.49	10
N3025105	8 x 8	White	PDL803.01	£10.99	£5.49	10
N3026016	10 x 10	White	PDX103.01	£10.99	£5.49	10
N3020046	6 x 6	Soft Cream	PDM603.32	£11.99	£9.49	10
N3025110	8 x 8	Soft Cream	PDL803.32	£11.99	£9.49	10
N3025115	10 x 10	Soft Cream	PDX103.32	£11.99	£9.49	10

Genesis PVC Straight Edge Trim

Can be used with standard ceramic tiles or with rectified or square cut tiles. Can also be used as a capping on the horizontal where skirting tiles have been fitted or where walls are not fully tiled. All versions available in 2.5m lengths



FROM
£1.45
each

Code	mm	Colour	Code	Price	Box Price	Box Qty
N3339100	6	White	ESP060.01	£3.32	£1.45	60
N3339105	8	White	ESP080.01	£3.32	£1.45	60
N3339107	10	White	ESP100.01	£3.32	£1.60	60
N3339108	12	White	ESP120.01	£3.32	£1.90	60
N3020064	8	Soft Cream	ESP080.32	£5.33	£1.75	60
N3020063	10	Soft Cream	ESP100.32	£5.33	£1.85	60
N3020062	12	Soft Cream	ESP120.32	£5.33	£1.90	60
N3020069	8	Grey	ESP080.11	£5.33	£1.75	60
N3020068	10	Grey	ESP100.11	£5.33	£1.85	60
N3020067	12	Grey	ESP120.11	£5.33	£1.90	60

Genesis PVC Seal Trim

A co-extruded bath seal with supportive leg for easy installation. Flexible fin absorbs slight movement without breaking seal. Leg can be removed if required. All versions available in 1.8m lengths



ONLY
£2.25
each

Code	mm	Colour	Code	Price	Box Price	Box Qty
N3120020	23	White	SBS180.01	£4.96	£2.25	25

Genesis PVC Edge Cap Trim

A flexible PVC capping seal used to finish the top of a resilient floor covering where it has been covered up the wall. Capping seals are usually used in conjunction with a cover former. Available in 2m lengths



ONLY
£3.99
each

Code	mm	Colour	Code	Price	Box Price	Box Qty
N3340013	2	White	KCS02.01	£4.99	£3.99	40

Genesis PVC Seal Trim

A co-extruded bath seal with supportive leg for easy installation. Flexible fin absorbs slight movement without breaking seal. Leg can be removed if required. All versions available in 1.8m lengths

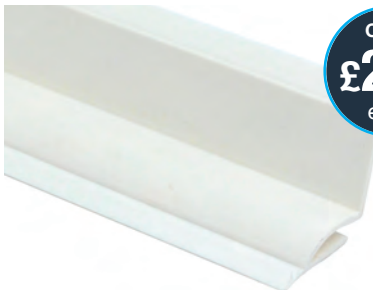

ONLY
£2.25
each

Code	mm	Colour	Code	Price	Box Price	Box Qty
N3120001	23	White	SPS180.01	£4.96	£2.25	25

Genesis PVC Vinyl To Tile Trim

Designed as a tile cap used where ceramic tiles are finished against a resilient floor finish that has been dressed up the wall to form a skirting. Available in 2.5m lengths



ONLY
£2.20
each



Code	mm	Colour	Code	Price	Box Price	Box Qty
N3340010	8	White	EVC080.01	£2.99	£2.20	50

Genesis PVC Vinyl To Tile Trim

P.V.C profiles that offer a neat transition between soft skirting and ceramic tiles. The cavity on the EVT profile allows for protection of the floor covering and the ceramic tile. Available in 2.5m lengths



FROM
£2.90
each

Code	mm	Colour	Code	Price	Box Price	Box Qty
N3080228	8	White	EVT080.01	£3.94	£2.50	25
N3340011	12	White	EVT120.01	£4.84	£2.90	25

Genesis Aluminium Quadrant Trim

Aluminium profile with a fully rounded quadrant face designed to protect the edges of tiles fitted in wall or floor installations. Available with corresponding Internal and External Aluminium corners avoiding the unsightly and exposed 45° cuts. All versions available in 2.5m lengths



FROM
£6.99
each

Code	mm	Colour	Code	Price	Box Price	Box Qty
N3310110	6	Bright Silver	EAQ060.91	£9	£6.99	20
N3310112	8	Bright Silver	EAQ080.91	£9	£6.99	20
N3310114	10	Bright Silver	EAQ100.91	£9	£6.99	20
N3310116	12	Bright Silver	EAQ120.91	£9	£6.99	20
N3310202	8	Brushed Silver	EAQ080.94	£9	£6.99	20
N3310204	10	Brushed Silver	EAQ100.94	£9	£6.99	20
N3310206	12	Brushed Silver	EAQ120.94	£9	£6.99	20
N3310102	8	Matt Silver	EAQ080.81	£9	£6.99	20
N3310104	10	Matt Silver	EAQ100.81	£9	£6.99	20
N3310106	12	Matt Silver	EAQ120.81	£9	£6.99	20

Genesis Aluminium Straight Edge Trim

Designed to protect corners avoiding the unsightly and fragile 45° cut. The defined square edge clearly outlines coverings such as rectified porcelain stoneware. Available in different materials, colours and finishes, these profiles offer a practical and aesthetic solution, ideal for walls and floors. All versions available in 2.5m lengths

FROM
£5.99
each

Code	mm	Colour	Code	Price	Box Price	Box Qty
N3311030	6	Bright Silver	ESA060.91	£9	£5.99	20
N3311032	8	Bright Silver	ESA080.91	£9	£5.99	20
N3311036	10	Bright Silver	ESA100.91	£9	£5.80	20
N3311038	12	Bright Silver	ESA120.91	£9	£5.99	20
N3311040	15	Bright Silver	ESA150.91	£11	£8.80	20
N3313052	8	Brushed Silver	ESA080.94	£9	£5.99	20
N3313054	10	Brushed Silver	ESA100.94	£9	£5.80	20
N3313056	12	Brushed Silver	ESA120.94	£9	£5.99	20
N3325011	8	Matt Black	ESA080.17	£9	£7.80	20
N3325012	10	Matt Black	ESA100.17	£9	£7.99	20
N3325013	12	Matt Black	ESA120.17	£9	£7.99	20
N3313001	6	Matt Silver	ESA060.81	£9	£7.00	20
N3313002	8	Matt Silver	ESA080.81	£9	£7.80	20
N3313004	10	Matt Silver	ESA100.81	£9	£7.99	20
N3313005	12	Matt Silver	ESA120.81	£9	£7.99	20
N3311002	8	Mill Finish	ESA080.80	£8	£4.20	20
N3311004	10	Mill Finish	ESA100.80	£8	£4.40	20
N3311005	12	Mill Finish	ESA120.80	£8	£4.80	20
N3325004	10	Pewter	ESA100.85	£9	£7.99	20
N3325005	12	Pewter	ESA120.85	£9	£7.99	20
N3311044	10	Chrome	ESA100.101	£33.33	£21.99	10
N3311046	12	Chrome	ESA120.101	£33.33	£23.49	10

Genesis Stainless Steel Straight Edge Trim

Superb resistance to principal chemical / atmospheric agents and particularly recommended to protect steps in zones such as food processing industries, breweries, dairies, hospitals. All versions available in 2.5m lengths.



FROM
£8.99
each

Code	mm	Colour	Code	Price	Box Price	Box Qty
N3338002	6	Mill Finish	ESS060.84	£16.99	£8.99	10
N3338004	8	Mill Finish	ESS080.84	£17.99	£9.19	10
N3338008	10	Mill Finish	ESS100.84	£18.99	£9.49	10
N3338009	12	Mill Finish	ESS120.84	£19.99	£10.98	10
N3338006	15	Mill Finish	ESS150.84	£20.99	£11.99	10

Genesis Aluminium Quadrant Trim Corner

Produced from Machined Aluminium to ensure perfect finish to compliment the profile. Available in packs of 2 pieces



FROM
£6.39
each

Code	mm	Colour	Code	Price	Box Price	Box Qty
N3310131	8	Bright Silver	EAC082.91	£7.99	£6.39	10
N3310133	10	Bright Silver	EAC102.91	£7.99	£6.39	10
N3310135	12	Bright Silver	EAC122.91	£8.99	£7.19	10
N3310123	8	Matt Silver	EAC082.81	£7.99	£6.39	10
N3310125	10	Matt Silver	EAC102.81	£7.99	£6.39	10
N3310126	12	Matt Silver	EAC122.81	£8.99	£7.19	10

Genesis Aluminium Square Trim

Can be used as an edge trim on the vertical with wall tiles or on the horizontal with floor tiles or even as a feature strip in wall or floor applications. Available with corner pieces to obviate sharp edges when mitring is necessary. Available in 2.5m lengths.



FROM
£6.20
each

Code	mm	Colour	Code	Price	Box Price	Box Qty
N3310118	10 x 10	Bright Silver	TDP100.91	£16.66	£6.20	20
N3310150	12 x 10	Bright Silver	TDP120.91	£16.66	£7.95	20
N3310119	10 x 10	Brushed Silver	TDP100.94	£16.66	£6.20	20
N3310152	12 x 10	Brushed Silver	TDP120.94	£16.66	£7.95	20
N3310178	10 x 10	Bright Copper	TDP100.95	£16.66	£6.20	20
N3310180	12 x 10	Bright Copper	TDP120.95	£16.66	£7.95	20

Genesis Aluminium Square Trim Corner

Produced from Machined Aluminium to ensure perfect finish to compliment the profile. All versions available in packs of 2.



FROM
£8.35
each

Code	mm	Colour	Code	Price	Box Price	Box Qty
N3310167	10	Bright Silver	EDP102.91	£10.30	£8.35	10
N3310171	12	Bright Silver	EDP122.91	£10.30	£8.35	10
N3310169	10	Brushed Silver	EDP102.94	£10.30	£8.35	10
N3310173	12	Brushed Silver	EDP122.94	£10.30	£8.35	10
N3310183	10	Bright Copper	EDP102.95	£13.75	£12.40	10
N3310185	12	Bright Copper	EDP122.95	£13.75	£12.40	10

Genesis Aluminium Priceello

Decorative profiles designed to create a feature in ceramic wall tile installations. All versions available in 2.5m lengths

ONLY
£28.79
each



ONLY
£11.20
each

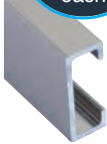

ONLY
£10.80
each



Code	mm	Colour	Code	Price
N3305092	10 x 8	Chrome	LFA100.101	£28.79
N3305093	20 x 8	Bright Silver	LFA200.91	£11.20
N3339130	10 x 7	Bright Silver	LPA100.91	£10.80

Genesis PVC Movement & Perimeter Joint

Light duty movement joint with highly durable blend of PVC/ rubber infill offering protection to the edge of the floor covering for pedestrian and light mechanical traffic, foot trolley etc. Conforms to British Standard BS 5385. All versions available in 2.5m lengths.

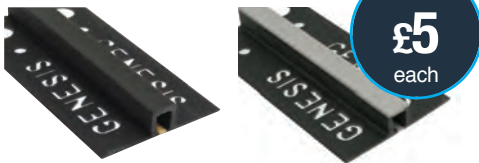

FROM
£5
each

Code	mm	Colour	Code	Price	Box Price	Box Qty
N3200242	10	Black	MLB100.16	£7.85	£5.00	25
N3200244	12	Black	MLB125.16	£9.15	£5.40	25
N3200243	10	Dark Grey	MLB100.35	£7.85	£5.00	25
N3200245	12	Dark Grey	MLB125.35	£9.15	£5.40	25

Genesis Expansion Joint Aluminium Optimax Heavy Duty Expansion Joint

Santoprene infill offers outstanding flexibility, chemical and weathering resistance, in addition the tensile strength. Durable anchoring angles are aluminium grade 6063 T6, which is heat treated to increase tensile strength. All versions available in 2.5m lengths

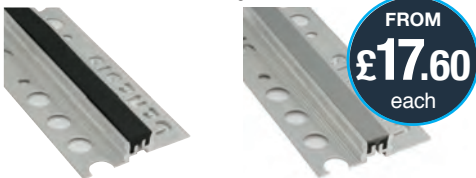

FROM
£17.60
each

Code	mm	Colour	Code	Price	Box Price	Box Qty
N3200251	10	Black	MSA100.16	£20.83	£17.60	10
N3200254	12	Black	MSA125.16	£22.49	£20.00	10
N3200250	10	Dark Grey	MSA100.35	£20.83	£17.60	10
N3200253	12	Dark Grey	MSA125.35	£22.49	£20.00	10

Genesis Aluminium Door Threshold Strips

Aluminium self adhesive door threshold strip. 0.92m long

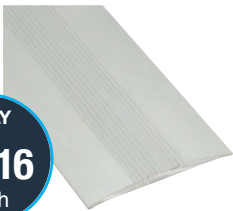

ONLY
£4.16
each

Code	mm	Colour	Code	Price	Box Price	Box Qty
N3200501	37 x 3	Matt Silver	CAS409.81	£8.32	£4.16	10
N3200502	37 x 3	Matt Brass	CAS409.83	£8.32	£4.16	10

Genesis Aluminium Door Threshold Strips

Aluminium self adhesive ramp threshold strip. 0.92m long

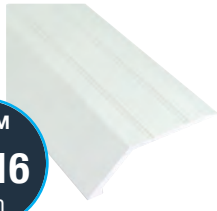

FROM
£4.16
each

Code	mm	Colour	Code	Price	Box Price	Box Qty
N3200503	43 x 10	Matt Silver	TAS109.81	£8.32	£4.16	10
N3200504	43 x 10	Matt Brass	TAS109.83	£8.32	£4.58	10

Genesis Aluminium Door Threshold Strips

Aluminium Z bar carper lock door threshold strip. 0.92m long

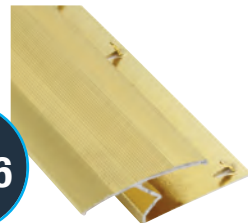

ONLY
£4.16
each

Code	mm	Colour	Code	Price	Box Price	Box Qty
N3200505	30 x 9	Polished Silver	TGA909.91	£8.32	£4.66	45
N3200506	30 x 9	Brass Effect	TGA909.87	£8.32	£4.16	45

Genesis Aluminium Door Threshold Strips

Aluminium fast fit ramp threshold strip. 0.92m long

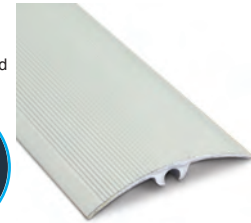

FROM
£4.99
each

Code	mm	Colour	Code	Price	Box Price	Box Qty
N3200507	40	Matt Silver	TCR409.81	£8.32	£4.99	20
N3200508	40	Matt Brass	TCR409.83	£8.32	£4.99	20
N3200509	40	Bright Silver	TCR409.91	£9.99	£5.83	20

Genesis Aluminium Door Threshold Strips

Aluminium Z bar door threshold strip. 0.92m long

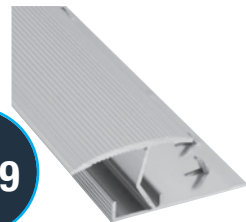

ONLY
£7.49
each

Code	mm	Colour	Code	Price	Box Price	Box Qty
N3200510	30 x 15	Brass effect	TGS159.87	£9.99	£7.49	45
N3200511	30 x 15	Bright Silver	TGS159.91	£9.99	£7.49	45



Swarovski Crystals - Straight

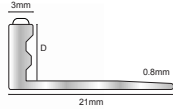

ONLY
£144
each

101S
Swarovski

Code	D (mm)	Length (m)	Box Qty	Price/Length
ESA080.101S	8	2.5	10	£144
ESA100.101S	10	2.5	10	£144
ESA120.101S	12	2.5	10	£144

Plated Stainless Steel - Square

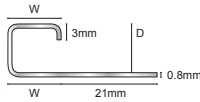

FROM
£23.65
each

195
Copper
see other finish options on page 100

Code	D (mm)	Length (m)	Box Qty	Price/Length
EQQ080.161	8mm	2.5	10	£23.65
EQQ080.187	8mm	2.5	10	£23.65
EQQ080.195	8mm	2.5	10	£23.65
EQQ100.161	10mm	2.5	10	£25.43
EQQ100.187	10mm	2.5	10	£25.43
EQQ100.195	10mm	2.5	10	£25.43
EQQ120.161	12mm	2.5	10	£27.45
EQQ120.187	12mm	2.5	10	£27.45
EQQ120.195	12mm	2.5	10	£27.45

Corner Pieces

Code	D (mm)	Type	Pack Qty	Price/Pack
EDQ082.161	8	3 way	2	£11.25
EDQ082.187	8	3 way	2	£11.25
EDQ082.195	8	3 way	2	£11.25
EDQ102.161	10	3 way	2	£11.25
EDQ102.187	10	3 way	2	£11.25
EDQ102.195	10	3 way	2	£11.25
EDQ122.161	12	3 way	2	£11.25
EDQ122.187	12	3 way	2	£11.25
EDQ122.195	12	3 way	2	£11.25

Plated Stainless Steel - Straight

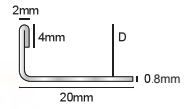
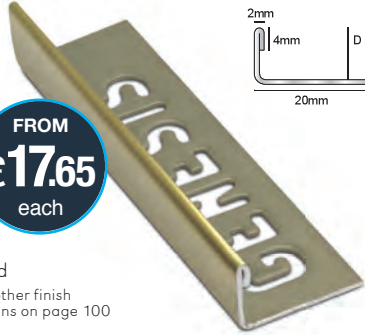

FROM
£17.65
each

187
Gold
see other finish options on page 100

Code	D (mm)	Length (m)	Box Qty	Price/Length
ESS080.161	8mm	2.5	10	£17.65
ESS080.187	8mm	2.5	10	£17.65
ESS080.195	8mm	2.5	10	£17.65
ESS100.161	10mm	2.5	10	£18.43
ESS100.187	10mm	2.5	10	£18.43
ESS100.195	10mm	2.5	10	£18.43
ESS120.161	12mm	2.5	10	£19.38
ESS120.187	12mm	2.5	10	£19.38
ESS120.195	12mm	2.5	10	£19.38

Swarovski Crystals - Square

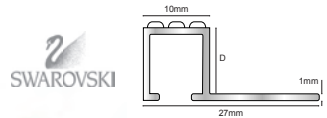

ONLY
£294
each

101S
Swarovski

Code	D (mm)	Length (m)	Box Qty	Price/Length
TDP100.101S	10	2.5	10	£294
TDP120.101S	12	2.5	10	£294

Corner Pieces

Code	D (mm)	Pack Qty	Price/Pack
EDP102.101S	10	2	£19.66
EDP122.101S	12	2	£19.66

Solid Brass - Straight



FROM
£30.84
each

87
Natural

Solid Brass - Square

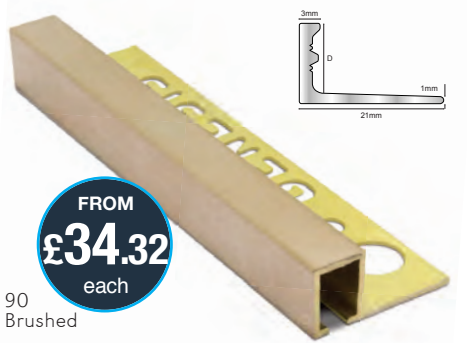

FROM
£34.32
each

90
Brushed

Code	D (mm)	Length (m)	Box Qty	Price/Length
ESB107.87	10mm	2.7	10	£30.84
ESB107.90	10mm	2.7	10	£30.84
ESB127.87	12mm	2.7	10	£35.16
ESB127.90	12mm	2.7	10	£35.16

Code	D (mm)	Length (m)	Box Qty	Price/Length
TDB107.87	10mm	2.7	10	£34.32
TDB107.90	10mm	2.7	10	£34.32
TDB127.87	12mm	2.7	10	£36.92
TDB127.90	12mm	2.7	10	£36.92

Swarovski Crystals can be applied to all TDP and ESA finishes on request



Aluminium Straight Edge & Formable Trim

Code	D (mm)	Length (m)	Finish	Box Qty	Price	Box Price
ESA030	2.25	2.5	80	20	£8	£4.60
ESA040	3.25	2.5	80	20	£8	£3.20
ESA050	4.25	2.5	80	20	£8	£3.50
ESA060	6	2.5	80	20	£8	£4.25
ESA060	6	2.5	01,81	20	£9	£7.00
ESA060	6	2.5	91	20	£9	£5.99
ESA080	8	2.5	80	20	£8	£4.20
ESA080	8	2.5	91,94	20	£9	£5.99
ESA080	8	2.5	01,16,17,81	20	£9	£7.80
ESA080	8	2.5	02,18,34,88	20	£14.16	£9.50
ESA080	8	2.5	101	20	£33.33	£16.00
ESA100	10	2.5	80	20	£8	£4.40
ESA100	10	2.5	91,94	20	£9	£5.80
ESA100	10	2.5	01,16,17,81,85,89	20	£9	£7.99
ESA100	10	2.5	02,18,34,86,88,90,95,20,96,411,414,425,435	20	£14.16	£9.50
ESA100	10	2.5	101	20	£33.33	£21.99
ESA120	12	2.5	80	20	£8	£4.80
ESA120	12	2.5	91,94	20	£9	£5.99
ESA120	12	2.5	01,16,17,81,85,89	20	£9	£7.99
ESA120	12	2.5	02,18,34,86,88,90,95,20,96,411,414,425,435	20	£14.16	£10.80
ESA120	12	2.5	101	20	£33.33	£23.49
ESA150	15	2.5	80	20	£9	£5.60
ESA150	15	2.5	91,94	20	£11	£8.80
ESA150	15	2.5	01,81	20	£11	£9.80
ESA180	18	2.5	80	20	£16	£5.50
ESA180	18	2.5	81,91	20	£17	£9.25
ESA225	22.5	2.5	80	20	£16	£6.70
ESA225	22.5	2.5	91	20	£18	£10.10

2.7m

Code	D (mm)	Length (m)	Finish	Box Qty	Price	Box Price
ESA067	6	2.7	81	20	£15.30	£7.95
ESA067	6	2.7	91	20	£17.99	£8.95
ESA087	8	2.7	81	20	£15.30	£7.95
ESA087	8	2.7	91,94	20	£17.99	£9.45
ESA107	10	2.7	81	20	£15.30	£7.95
ESA107	10	2.7	91,94	20	£17.99	£9.45
ESA127	12	2.7	81	20	£17.99	£8.95

Code	D (mm)	Length (m)	Finish	Box Qty	Price	Box Price
EFA060	6	2.5	80	20	£12.49	£5.49
EFA080	8	2.5	80	20	£12.49	£5.49
EFA100	10	2.5	80	20	£12.49	£6.75
EFA120	12	2.5	80	20	£12.49	£7.80
EFA150	15	2.5	80	20	£12.49	£7.45
EFA180	18	2.5	80	20	£12.49	£8.45

Corner Pieces

Code	D (mm)	Finish	Pack Qty	Price/Pack
ESC082	8	81,91,94	2	£7.80
ESC102	10	81,91,94	2	£7.80
ESC122	12	81,91,94	2	£7.80

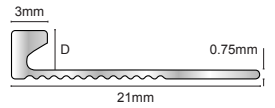

ESA030,040,050

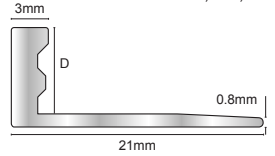

ESA060 onwards





We can now powder coat our Aluminium & Stainless Steel profiles to any number in the Classic RAL Guide



01 White	02* Matt White	16 Black	17 Matt Black	18 Brushed Black	34* Soft Grey
80* Mill Aluminium	81 Matt Silver	85 Pewter	86 Bright Brass	88 Nickel	89 Bronze
90 Brushed Brass	91 Bright Silver	92 Matt Nickel	94 Brushed Effect	95 Bright Copper	96 Brushed Copper
101 Chrome Plated	411* Granite	414* Bath Stone	425* Sand Stone	435* Dark Granite	

Aluminium Medium Duty Trim



ONLY
£16.66
each

80
Mill Aluminium

Code	D (mm)	Length (m)	Box Qty	Price/Length
EMA080.80	8	2.5	20	£16.66
EMA100.80	10	2.5	20	£16.66
EMA120.80	12	2.5	20	£16.66

Aluminium Slim Trim - Square

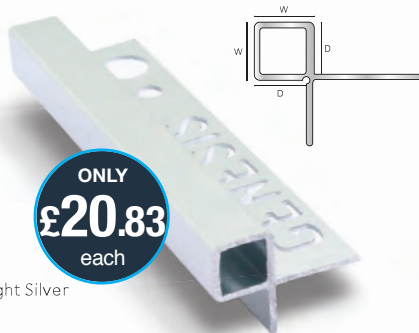

ONLY
£20.83
each

91
Bright Silver

Code	D (mm)	Length (m)	Box Qty	Price/Length
EAM080.91	9 x 8	2.5	20	£20.83
EAM100.91	11 x 10	2.5	20	£20.83

Aluminium Slim Square Edge Trim & Corners

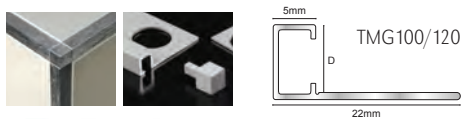

FROM
£12.49
each

91
Bright Silver

Code	D (mm)	Length (m)	Box Qty	Price/Length
TMG050.91	5	2.5	20	£16.66
TMG100.91	10	2.5	20	£16.66
TMG120.91	12	2.5	20	£16.66

Corner Pieces

Code	D (mm)	Type	Pack Qty	Price/Pack
EMG052.91	5	Int / Ext	2	£12.49
EMG102.91	10	Int / Ext	2	£12.49
EMG122.91	12	Int / Ext	2	£12.49

Aluminium Contour Trim & Corners



FROM
£9.58
each

91
Bright Silver
see other finish
options on page 100

Code	W x D (mm)	Length (m)	Box Qty	Price/Length
TDG084.81	8 x 8	2.5	20	£20.82
TDG084.91	8 x 8	2.5	20	£20.82
TDG104.81	10 x 10	2.5	20	£20.82
TDG104.91	10 x 10	2.5	20	£20.82
TDG124.81	12 x 12	2.5	20	£20.82
TDG124.91	12 x 12	2.5	20	£20.82

Corner Pieces

Code	D (mm)	Pack Qty	Price/Pack
ECG082.81	8	2	£9.58
ECG082.91	8	2	£9.58
ECG102.81	10	2	£9.58
ECG102.91	10	2	£9.58
ECG122.81	12	2	£9.58
ECG122.91	12	2	£9.58

Aluminium Internal Square & End Caps

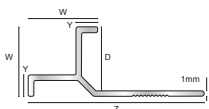

FROM
£13.33
each

91
Bright Silver



Aluminium Angle Trim & Corners

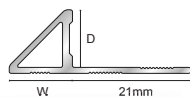

FROM
£14.16
each

94
Brushed Effect
see other finish
options on page 100



Code	W x D (mm)	Z (mm)	Length (m)	Box Qty	Price/Length
EIK100.91	11 x 10	31	2.5	20	£16.66
EIK120.91	13 x 12	33	2.5	20	£16.66

End Caps

Code	D (mm)	Pack Qty	Price/Pack
ECK102.91	10	2	£13.33
ECK122.91	12	2	£13.33

Code	W x D (mm)	Length (m)	Box Qty	Price/Length
EAT080.81	9 x 8	2.7	20	£20.83
EAT080.91	9 x 8	2.7	20	£20.83
EAT080.94	9 x 8	2.7	20	£20.83
EAT100.81	11 x 10	2.7	20	£20.83
EAT100.91	11 x 10	2.7	20	£20.83
EAT100.94	11 x 10	2.7	20	£20.83
EAT120.81	13 x 12	2.7	20	£20.83
EAT120.91	13 x 12	2.7	20	£20.83
EAT120.94	13 x 12	2.7	20	£20.83

Corner Pieces

Code	D (mm)	Type	Pack Qty	Price/Pack
EET082.91	8	External	2	£14.16
EET082.94	8	External	2	£14.16
EET102.81	10	External	2	£14.16
EET102.91	10	External	2	£14.16
EET102.94	10	External	2	£14.16
EET122.81	12	External	2	£14.16
EET122.91	12	External	2	£14.16
EET122.94	12	External	2	£14.16
EIT082.91	8	Internal	2	£14.16
EIT082.94	8	Internal	2	£14.16
EIT102.81	10	Internal	2	£14.16
EIT102.91	10	Internal	2	£14.16
EIT102.94	10	Internal	2	£14.16
EIT122.81	12	Internal	2	£14.16
EIT122.91	12	Internal	2	£14.16
EIT122.94	12	Internal	2	£14.16

Aluminium Angle Trim - Slim

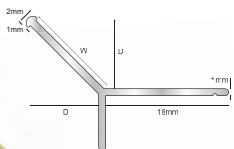

ONLY
£14.16
each

86
Bright Brass
see other finish
options on page 100



Code	W x D (mm)	Length (m)	Box Qty	Price/Length
EAD080.86	12 x 8	2.5	20	£14.16
EAD080.91	12 x 8	2.5	20	£14.16
EAD100.86	15 x 10	2.5	20	£14.16
EAD100.91	15 x 10	2.5	20	£14.16
EAD120.86	18 x 12	2.5	20	£14.16
EAD120.91	18 x 12	2.5	20	£14.16



Aluminium Square Trim & Corners

Code	W x D (mm)	L(m)	Finish	Qty	Price	Box Price
TDP080	10 x 8	2.5	81	20	£16.66	£9.00
TDP080	10 x 8	2.5	82,91,94,95,96	20	£16.66	£6.20
TDP100	10 x 10	2.5	01,16,17,81	20	£16.66	£9.00
TDP100	10 x 10	2.5	02,18,34,82,86,90,91,94,95,96	20	£16.66	£6.20
TDP100	10 x 10	2.5	101	10	£29.99	£27.50
TDP100	10 x 10	2.5	411,414,425,435	20	£16.66	£12.95
TDP120	10 x 12	2.5	01,16,17,81	20	£16.66	£9.50
TDP120	10 x 12	2.5	02,18,34,82,86,90,91,94,95,96	20	£16.66	£7.95
TDP120	10 x 12	2.5	101	10	£29.99	£28
TDP120	10 x 12	2.5	411,414,425,435	20	£16.66	£13.45
TDP150	10 x 15	2.5	81	20	£16.66	£13.35
TDP150	10 x 15	2.5	91,94	20	£16.66	£8.65

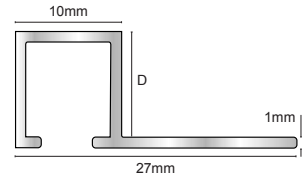

FROM
£6.20
each

Corner Pieces

Code	D (mm)	Qty	Finish	Qty	Pack	Box Price
EDP082	8	2	81,91,94	2	£10.30	£9.30
EDP082	8	2	82,95,96	2	£13.75	£12.40
EDP102	10	2	01,16,17,18,81,91,94,90	2	£10.30	£8.35
EDP102	10	2	82,95,96	2	£13.75	£12.40
EDP102	10	2	101	2	£15.72	£14.95
EDP122	12	2	01,16,17,18,81,91,94,90	2	£10.30	£8.35
EDP122	12	2	82,95,96	2	£13.75	£12.40
EDP122	12	2	101	2	£15.72	£14.95
EDP152	15	2	81,91	2	£10.30	£8.35
EDP152	15	2	94	2	£13.75	£12.40



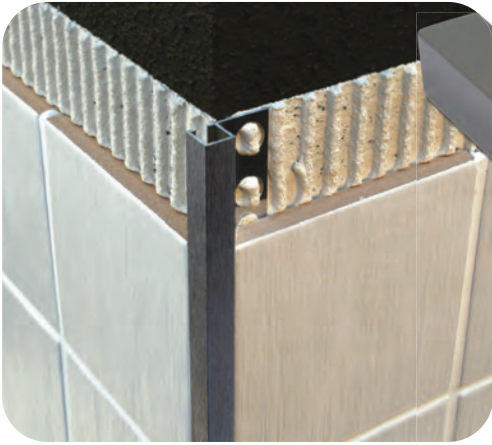

01
White



02*
Matt White



16
Black



17
Matt Black



18
Brushed Black



34*
Soft Grey



81
Matt Silver



82
Anthracite



86
Bright Brass

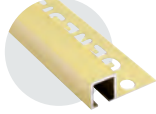

90
Brushed Brass

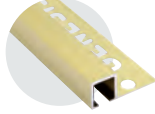

91
Bright Silver



94
Brushed Effect



95
Bright Copper



96
Brushed Copper

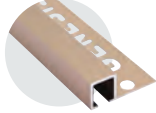

101
Chrome Plated



411*
Granite

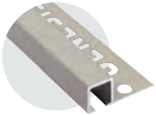

414*
Bath Stone



425*
Sand Stone



435*
Dark Granite



Aluminium Round Edge



ONLY
£12.49
 each

91
 Bright Silver
 see other finish
 options on page 100

Code	D (mm)	Length (m)	Box Qty	Price/Length
ERA080.91	8	2.5	20	£12.49
ERA100.81	10	2.5	20	£12.49
ERA100.91	10	2.5	20	£12.49
ERA120.81	12	2.5	20	£12.49
ERA120.91	12	2.5	20	£12.49

Aluminium Pro Trim & Corners



ONLY
£14.16
 each

94
 Brushed Effect
 see other finish
 options on page 100

Code	W/D (mm)	Length (m)	Box Qty	Price/Length
ETA060.81	6	2.5	20	£14.16
ETA060.91	6	2.5	20	£14.16
ETA080.81	8	2.5	20	£14.16
ETA080.91	8	2.5	20	£14.16
ETA080.94	8	2.5	20	£14.16
ETA100.81	10	2.5	20	£14.16
ETA100.91	10	2.5	20	£14.16
ETA100.94	10	2.5	20	£14.16
ETA120.81	12	2.5	20	£14.16
ETA120.91	12	2.5	20	£14.16
ETA120.94	12	2.5	20	£14.16

Corner Pieces - see EAC / EIQ opposite

Aluminium Self Adhesive Internal Trim, Corners & Caps



FROM
£8.33
 each

81
 Matt Silver

Code	D (mm)	Length (m)	Box Qty	Price/Length
EWA150.81	11.5	2.5	20	£8.33
EWA150.91	11.5	2.5	20	£8.33

Corner Piece & End Caps

Code	D (mm)	Type	Pack Qty	Price/Pack
EWI150.81	11.5	Internal Corner	2	£8.33
EWI150.91	11.5	Internal Corner	2	£8.33
EWE150.81	11.5	External Corner	2	£8.33
EWE150.91	11.5	External Corner	2	£8.33
EWC150.81	11.5	End Caps	2	£12.91
EWC150.91	11.5	End Caps	2	£12.91



**PROTECTIVE
FILM**

EXCL. 80



FROM
£4.90
each

Code	D (mm)	L (m)	Finish	Qty	Price	Box Price
EAQ060	6	2.5	01,81	20	£9	£6.99
EAQ060	6	2.5	91	20	£9	£6.99
EAQ080	8	2.5	80	20	£9	£5.99
EAQ080	8	2.5	01,81	20	£9	£6.99
EAQ080	8	2.5	91,94	20	£9	£6.99
EAQ100	10	2.5	80	20	£9	£4.90
EAQ100	10	2.5	01,16,81,85	20	£9	£6.99
EAQ100	10	2.5	86,91,94,95,96	20	£9	£6.99
EAQ120	12	2.5	80	20	£9	£5.40
EAQ120	12	2.5	01,16,81,83,85	20	£9	£6.99
EAQ120	12	2.5	91,94,95,96	20	£9	£6.99

Internal Corners

Code	D (mm)	Type	Finish	Qty	Pack	Box Price
EIQ082	8	Internal	81,91	2	£8.99	£7.39
EIQ082	8	Internal	94	2	£9.99	£8.39
EIQ102	10	Internal	81,91,95,96	2	£8.99	£7.39
EIQ102	10	Internal	86,94	2	£9.99	£8.39
EIQ122	12	Internal	81,91,95,96	2	£8.99	£7.39
EIQ122	12	Internal	94	2	£9.99	£8.39

External Corners

Code	D (mm)	Type	Finish	Qty	Pack	Box Price
EAC062	6	External	91	2	£7.99	£6.39
EAC082	8	External	01,16,80,81,91,94	2	£7.99	£6.39
EAC102	10	External	01,16,80,81,86,91,94,95,96	2	£7.99	£6.39
EAC122	12	External	01,16,80,81,91,94,95,96	2	£8.99	£7.19

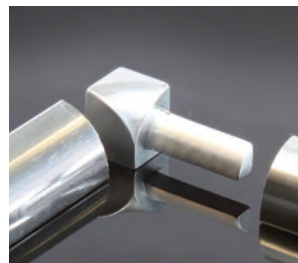

01
White



16
Black



80
Mill Aluminium



81
Matt Silver



85
Pewter



86
Bright Brass



91
Bright Silver



94
Brushed Effect

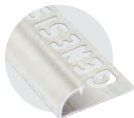

95
Bright Copper



96
Brushed Copper



Aluminium Dividing Strip



ONLY
£8.33
each

80
Mill Aluminium
see other finish
options on page 100

Code	W x D (mm)	Length (m)	Box Qty	Price/Length
EDA510.80	5 x 10	2.5	20	£8.33
EDA310.91	3 x 10	2.5	20	£8.33

Aluminium Dividing Strip



ONLY
£8.33
each

81
Matt Silver
see other finish
options on page 100

Code	W x D (mm)	Length (m)	Box Qty	Price/Length
EDA147.81	14 x 8	2.5	20	£8.33
EDA147.91	14 x 8	2.5	20	£8.33

Aluminium Dividing Strip



FROM
£9.16
each

83
Matt Brass
see other finish
options on page 100

Code	W x D (mm)	Length (m)	Box Qty	Price/Length
EDA408.81	22 x 9	2.5	20	£4.16
EDA408.83	22 x 9	2.5	20	£4.16
EDA408.91	22 x 9	2.5	20	£5.50

Stainless Steel Dividing Strip



ONLY
£21.66
each

84
Stainless Steel
see other finish
options on page 100

Code	W x D (mm)	Length (m)	Box Qty	Price/Length
EDS209.84	20 x 9	2.5	10	£21.66
EDS209.102	20 x 9	2.5	10	£21.66

Stainless Steel Square Edge Trim & Corners

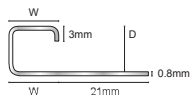

FROM
£11.66
each

84
Stainless Steel
see other finish
options on page 100

Stainless Steel Quadrant Trim & Corners

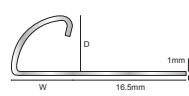

FROM
£15.83
each

84
Stainless Steel
see other finish
options on page 100

Stainless Steel Square Edge Trim - Grade 304

Code	W x D (mm)	Length (m)	Box Qty	Price/Length
EQQ080.84	8 x 8	2.5	10	£20.41
EQQ080.102	8 x 8	2.5	10	£24.16
EQQ100.84	10 x 10	2.5	10	£20.83
EQQ100.102	10 x 10	2.5	10	£26.24
EQQ120.84	12 x 12	2.5	10	£22.49
EQQ120.102	12 x 12	2.5	10	£28.33

Stainless Steel Square Edge Trim - Grade 316

Code	D (mm)	Length (m)	Box Qty	Price/Length
EQQ308.84	8 x 8	2.5	10	£24.99
EQQ308.102	8 x 8	2.5	10	£29.58
EQQ310.84	10 x 10	2.5	10	£26.24
EQQ310.102	10 x 10	2.5	10	£31.24
EQQ312.84	12 x 12	2.5	10	£28.33
EQQ312.102	12 x 12	2.5	10	£32.91

Corner Pieces

Code	D (mm)	Pack Qty	Price/Pack
EDQ082.84	8	2	£11.66
EDQ082.102	8	2	£11.66
EDQ102.84	10	2	£11.66
EDQ102.102	10	2	£11.66
EDQ122.84	12	2	£11.66
EDQ122.102	12	2	£11.66

Stainless Steel Quadrant Trim - Grade 304

Code	W/D (mm)	Length (m)	Box Qty	Price/Length
ESQ060.84	6	2.5	10	£15.83
ESQ060.102	6	2.5	10	£20.99
ESQ080.84	8	2.5	10	£17.49
ESQ080.102	8	2.5	10	£22.49
ESQ100.84	10	2.5	10	£18.74
ESQ100.102	10	2.5	10	£23.74
ESQ120.84	12	2.5	10	£20.41
ESQ120.102	12	2.5	10	£23.74

Stainless Steel Quadrant Trim - Grade 316

Code	D (mm)	Length (m)	Box Qty	Price/Length
ESQ308.84	8	2.5	10	£23.74
ESQ308.102	8	2.5	10	£28.74
ESQ310.84	10	2.5	10	£24.99
ESQ310.102	10	2.5	10	£29.58
ESQ312.84	12	2.5	10	£25.83
ESQ312.102	12	2.5	10	£30.83

Stainless Steel Quadrant Trim Corners - Grade 304

Code	D (mm)	Pack Qty	Price/Pack
ECQ082.84	8	2	£20.83
ECQ082.102	8	2	£20.83
ECQ102.84	10	2	£20.83
ECQ102.102	10	2	£20.83
ECQ122.84	12	2	£20.83
ECQ122.102	12	2	£20.83



Stainless Steel Straight Edge & Formable Trim



FROM
£13.33
each

84
Stainless Steel
see other finish
options on page 100

Stainless Steel Straight Edge Trim - Grade 304

Code	D (mm)	Length (m)	Box Qty	Price/Length
ESS045.84	4.5	2.5	10	£13.33
ESS045.102	4.5	2.5	10	£17.91
ESS060.84	6	2.5	10	£13.74
ESS060.102	6	2.5	10	£18.74
ESS080.84	8	2.5	10	£14.58
ESS080.102	8	2.5	10	£19.16
ESS100.84	10	2.5	10	£14.99
ESS100.102	10	2.5	10	£19.99
ESS120.84	12	2.5	10	£15.83
ESS120.102	12	2.5	10	£20.49
ESS150.84	15	2.5	10	£17.08
ESS150.102	15	2.5	10	£22.08
ESS180.84	18	2.5	10	£17.91
ESS180.102	18	2.5	10	£22.91
ESS225.84	22.5	2.5	10	£19.16
ESS225.102	22.5	2.5	10	£24.16

Stainless Steel Straight Edge Trim - Grade 316

Code	D (mm)	Length (m)	Box Qty	Price/Length
ESS310.84	10	2.5	10	£20.83
ESS310.102	10	2.5	10	£25.83
ESS312.84	12	2.5	10	£22.08
ESS312.102	12	2.5	10	£27.08

Formable

Code	D (mm)	Length (m)	Box Qty	Price/Length
ESF100.84	10	2.5	10	£19.58
ESF100.102	10	2.5	10	£23.74
ESF120.84	12	2.5	10	£24.99
ESF120.102	12	2.5	10	£24.99



Stainless Steel Straight Edge & Formable Trim

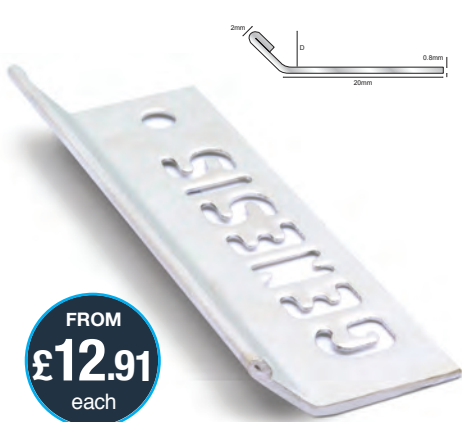

FROM
£12.91
each

84
Stainless Steel

Stainless Steel Listello

Code	D (mm)	Length (m)	Box Qty	Price/Length
ETS045.84	4.5	2.5	10	£12.91
ETS070.84	7	2.5	10	£13.33
ETS100.84	10	2.5	10	£14.58

Stainless Steel Listello



ONLY
£22.08
each

84
Stainless Steel
see other finish
options on page 100

Code	W x D (mm)	Length (m)	Box Qty	Price/Length
LPS250.84	25 x 8	2.5	10	£22.08
LPS250.102	25 x 8	2.5	10	£22.08
LPS400.84	40 x 8	2.5	10	£22.08
LPS400.102	40 x 8	2.5	10	£22.08

Aluminium Listello



FROM
£10.80
each

91
Bright Silver

Code	W x D (mm)	Length (m)	Box Qty	Price/Length
LPA100.91	10 x 7	2.5	20	£10.80
LPA250.91	25 x 7	2.5	20	£11.20

Glass Panel / Shadow Gap

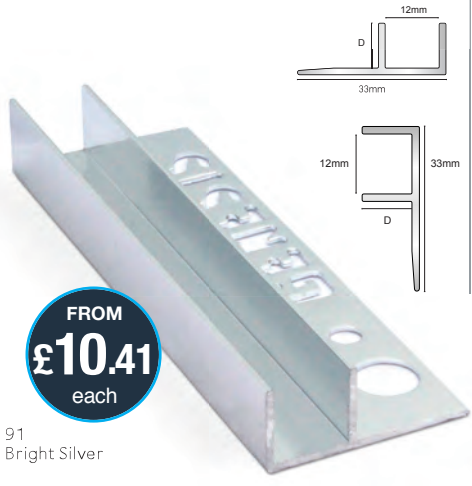

FROM
£10.41
each

91
Bright Silver

Code	W x D (mm)	Length (m)	Box Qty	Price/Length
LGA080.91	12 x 8	2.5	10	£10.41
LGA100.91	12 x 10	2.5	10	£11.24
LGA125.91	12 x 12.5	2.5	10	£12.08

Aluminium Self Adhesive Internal Trim, Corners & Caps

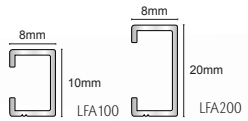

FROM
£5.83
each

Code	W x D (mm)	Length (m)	Box Qty	Price/Length
LFA100.81	10 x 8	2.5	20	£5.83
LFA100.86	10 x 8	2.5	20	£6.66
LFA100.91	10 x 8	2.5	20	£6.66
LFA100.94	10 x 8	2.5	20	£6.66
LFA100.101	10 x 8	2.5	20	£29.99
LFA200.16	20 x 8	2.5	20	£6.66
LFA200.17	20 x 8	2.5	20	£6.66
LFA200.18	20 x 8	2.5	20	£7.49
LFA200.86	20 x 8	2.5	20	£7.49
LFA200.90	20 x 8	2.5	20	£7.49
LFA200.91	20 x 8	2.5	20	£7.49
LFA200.94	20 x 8	2.5	20	£12.91
LFA200.411	20 x 8	2.5	20	£12.91
LFA200.414	20 x 8	2.5	20	£12.91
LFA200.425	20 x 8	2.5	20	£12.91
LFA200.435	20 x 8	2.5	20	£14.50

NEW
NEW
NEW
NEW
NEW
NEW
NEW
NEW
NEW
NEW
NEW

86
Bright Brass Effect
see other finish options on page 100

425
Sand Stone
see other finish options on page 100

End - U



ONLY
£6.66
each

91
Bright Silver

Code	W x D(mm)	Length (m)	Box Qty	Price
PUA118.91	6 x 11.5	2.4	50	£6.66

H - Joint



ONLY
£9.99
each

91
Bright Silver

Code	W x D(mm)	Length (m)	Box Qty	Price
PHA118.91	11 x 11.5	2.4	50	£9.99

External



ONLY
£16.24
each

91
Bright Silver

Code	W x D(mm)	Length (m)	Box Qty	Price
PXA118.91	30 x 11.5	2.4	25	£16.24

H - Joint



FROM
£12.49
each

91
Bright Silver

Code	W x D(mm)	Length (m)	Box Qty	Price
PIA118.81	15 x 11.5	2.4	25	£12.49
PIA118.91	15 x 11.5	2.4	25	£13.33



Panel Profile Finish Options

01
White

81
Matt Silver

91
Bright Silver

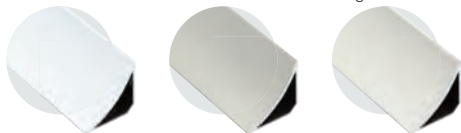

Scotia Retro Fit



ONLY
£8.74
each

91
Bright Silver

Code	W x D(mm)	Length (m)	Box Qty	Price
PSA308.01	30 x 19	2.4	50	£8.47
PSA308.81	30 x 19	2.4	50	£8.47
PSA308.91	30 x 19	2.4	50	£8.47

NEW Glass / Shower Deck Profiles

A stainless steel line profile which allows you to accurately configure tiled showers flush with the floor. Developed in order to cover the slope of 2%* it makes the shower area aesthetically perfect and at one with the modern trends of interior design.

*2% @ 889mm, 1% @ 1189mm.

FROM
£16.24
each

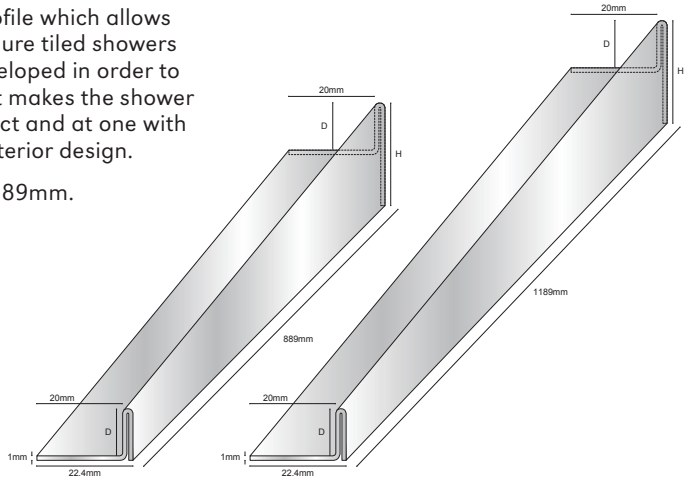

Code	D (mm)	H (mm)	Length (m)	Drop	Finish	Box Qty	Price
ESL099	9	22	0.889	Left	84	10	£16.24
ESL092	9	22	1.189	Left	84	10	£20.83
ESL119	11	24	0.889	Left	84	10	£17.49
ESL112	11	24	1.189	Left	84	10	£22.49
ESL129	12.5	25.5	0.889	Left	84	10	£19.16
ESL122	12.5	25.5	1.189	Left	84	10	£24.58
ESR099	9	22	0.889	Right	84	10	£16.24
ESR092	9	22	1.189	Right	84	10	£20.83
ESR119	11	24	0.889	Right	84	10	£17.49
ESR112	11	24	1.189	Right	84	10	£22.49
ESR129	12.5	25.5	0.889	Right	84	10	£19.16
ESR122	12.5	25.5	1.189	Right	84	10	£24.58



Aluminium Retro-Fit Protector



FROM
£4.58
each

81
Matt Silver

see other finish options on page 100

Self Adhesive

Code	W x D (mm)	Length (m)	Box Qty	Price/Length
EAA100.81	10 x 10	2.5	20	£4.58
EAA100.91	10 x 10	2.5	20	£4.99
EAA206.11	20 x 20	2.5	20	£6.24
EAA206.81	20 x 20	2.5	20	£6.24
EAA206.82	20 x 20	2.5	20	£6.24
EAA206.91	20 x 20	2.5	20	£7.08
EAA206.94	20 x 20	2.5	20	£7.08

Non Adhesive

Code	W x D (mm)	Length (m)	Box Qty	Price/Length
EAA254.81	25 x 25	2.5	20	£7.58

Stainless Steel Retro-Fit Protector - Self Adhesive



FROM
£16.66
each

195
Copper

see other finish options on page 100

Code	W x D (mm)	Length (m)	Box Qty	Price/Length
EAS154.84	15 x 15	2.5	10	£16.66
EAS154.102	15 x 15	2.5	10	£16.66
EAS304.84	30 x 30	2.5	10	£22.91
EAS304.102	30 x 30	2.5	10	£22.91
EAS304.117	30 x 30	2.5	10	£27.08
EAS304.187	30 x 30	2.5	10	£27.08
EAS304.195	30 x 30	2.5	10	£27.08
EAS504.84	50 x 50	2.5	10	£32.49
EAS504.102	50 x 50	2.5	10	£32.49
EAS504.117	50 x 50	2.5	10	£24.99
EAS504.187	50 x 50	2.5	10	£24.99
EAS504.195	50 x 50	2.5	10	£24.99
EAS515.84	50 x 50	1.5	10	£19.16

Aluminium Self Adhesive Internal Trim, Corners & Caps



Code	W x D (mm)	Length (m)	Box Qty	Price/Length
EPS310.84	30 x 10	2.5	10	£56.65
EPS310.102	30 x 10	2.5	10	£56.65
EPS312.84	30 x 12	2.5	10	£56.65
EPS312.102	30 x 12	2.5	10	£56.65
EPS510.84	50 x 10	2.5	10	£64.15
EPS510.102	50 x 10	2.5	10	£64.15
EPS512.84	50 x 12	2.5	10	£64.15
EPS512.102	50 x 12	2.5	10	£64.15



FROM
£56.65
each

84
Stainless Steel

see other finish options on page 100

Aluminium Clip On Skirting, Corners & End Caps



Code	W x D (mm)	Length (m)	Box Qty	Price/Length
KAC710.81	10 x 70	2.5	10	£20.42

Aluminium Clip On Skirting Pre-formed External Corners

Code	W x D x L(mm)	Description	Pack Qty	Price/Each
KEC710.81	10 x 70 x 80	External corner	1	£5.41
KIC710.81	10 x 70 x 80	Internal corner	1	£5.41

Aluminium Clip On Skirting End Caps

Code	W x D (mm)	Description	Pack Qty	Price/Each
KLC710.81	10 x 70	Left end cap	1	£7.49
KRC710.81	10 x 70	Right end cap	1	£7.49

Powder coating and anodising options available, please contact us for details.



81
Matt Silver

Aluminium Skirting, Corners & End Caps

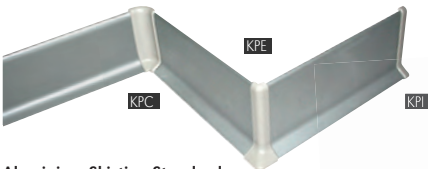

Aluminium Skirting Standard

Code	D (mm)	Length (m)	Box Qty	Price/Length
KAA607.81	60	2.7	10	£13.33
KAA807.81	80	2.7	10	£17.08
KAA107.81	100	2.7	10	£21.66

P.V.C. Skirting Corners & End Caps

Code	Description	Box Qty	Price/Each
KPE600.11	External Corner for KAA600/KAS600	20	£1.00
KPI600.11	Internal Corner for KAA600/KAS600	20	£1.00
KPC600.11	Pair End Caps (L/R) for KAA600/KAS600	20	£1.41
KPE800.11	External Corner for KAA800/KAS800	20	£1.09
KPI800.11	Internal Corner for KAA800/KAS800	20	£1.09
KPC800.11	Pair End Caps (L/R) for KAA800/KAS800	20	£1.55
KPE100.11	External Corner for KAA100/KAS100	20	£1.20
KPI100.11	Internal Corner for KAA100/KAS100	20	£1.20
KPC100.11	Pair End Caps (L/R) for KAA100/KAS100	20	£1.71

Powder coating and anodising options available, please contact us for details.



81
Matt Silver

NEW Aluminium Angle Edge



ONLY
£14.58
each

81
Matt Silver

Code	W x D (mm)	Length (m)	Box Qty	Price
TVI037.81	25 x 25	2.7	10	£14.58
TVI037.89	25 x 25	2.7	10	£14.58

NEW Aluminium Reducer



FROM
£10.83
each

81
Matt Silver

Code	W x D (mm)	Length (m)	Box Qty	Price
TVR037.81	38 x 3	2.7	10	£10.83
TVR037.89	38 x 3	2.7	10	£10.83
TVR057.81	39 x 5	2.7	10	£16.66
TVR057.89	39 x 5	2.7	10	£16.66



NEW Aluminium Angle Edge



FROM
£15.83
each

89
Bronze

Code	D (mm)	H (mm)	Length (m)	Box Qty	Price
TVN037.81	19.5	3	2.7	10	£15.83
TVN037.89	19.5	3	2.7	10	£15.83
TVN057.81	21.5	5	2.7	10	£16.66
TVN057.89	21.5	5	2.7	10	£16.66

NEW Aluminium U Profile



FROM
£9.16
each

89
Bronze

Code	W x D (mm)	H (mm)	Length (m)	Box Qty	Price
TVE037.81	6 x 5.6	3	2.7	10	£9.16
TVE037.89	6 x 5.6	3	2.7	10	£9.16
TVE057.81	8.5 x 7.6	5	2.7	10	£11.24
TVE057.89	8.5 x 7.6	5	2.7	10	£11.24

For additional finishing solutions the following profiles are also LVT compatible

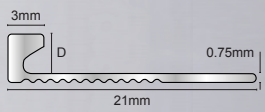

ESA030,040,050

Page 4

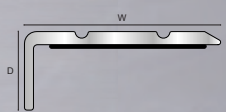

NAS

Page 68

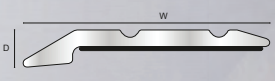

TAV

Page 80

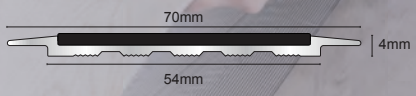

TSL

Page 83



Trim Regular & Corners

Code	D (mm)	L(m)	Finish	Qty	Price	Box Price
ETR608	6	2.5	01	100	£3.32	£0.99
ETR608	6	2.5	11,16,32,34,111	100	£5.33	£1.25
ETR708	7	2.5	01	100	£3.32	£1.15
ETR808	8	2.5	01	60	£3.32	£1.35
ETR808	8	2.5	09,10,11,12,13,14,16, 20,25,26,32,34,111	60	£5.33	£1.35
ETR808	8	2.5	62,63,64,70,72,116	60	£9.99	£4.99
ETR108	10	2.5	01	60	£3.32	£1.35
ETR108	10	2.5	09,10,11,12,13,14,16,20,24,2 5,26,32,34,111	60	£5.33	£1.45
ETR108	10	2.5	60,62,70,72,81,91	60	£9.99	£4.99
ETR128	12	2.5	01	60	£3.32	£1.45
ETR128	12	2.5	09,10,11,14,16,25,32,34,111	60	£5.33	£1.60
ETR128	12	2.5	64,70	60	£9.99	£4.99
PDM603	6		01	100	£10.99	£5.49
PDM603	6		10,11,14,16,25,32,34	100	£11.99	£9.49
PDP604	6		01	4	£1.60	£1.60
PDM603	6		16,34	4	£2.00	£2.00
PDL803	8		01	100	£10.99	£5.49
PDL803	8		10,11,14,16,25,32,34	100	£11.99	£9.49
PDP804	8		01	4	£1.60	£1.60
PDP804	8		16,34	4	£2.00	£2.00
PDX103	10		01	100	£10.99	£5.49
PDX103	10		10,11,14,16,25,32,34	100	£11.99	£9.49
PDP104	10		01	4	£1.60	£1.60
PDP104	10		16,34	4	£2.00	£2.00
PDX123	12		01	100	£10.99	£5.49
PDX123	12		10,11,14,16,25,32,34	100	£11.99	£9.49
PDP124	12		01	4	£1.99	£1.99
PDP124	12		16,34	4	£2.49	£2.49

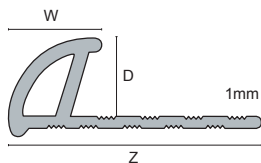

FROM
99p
each



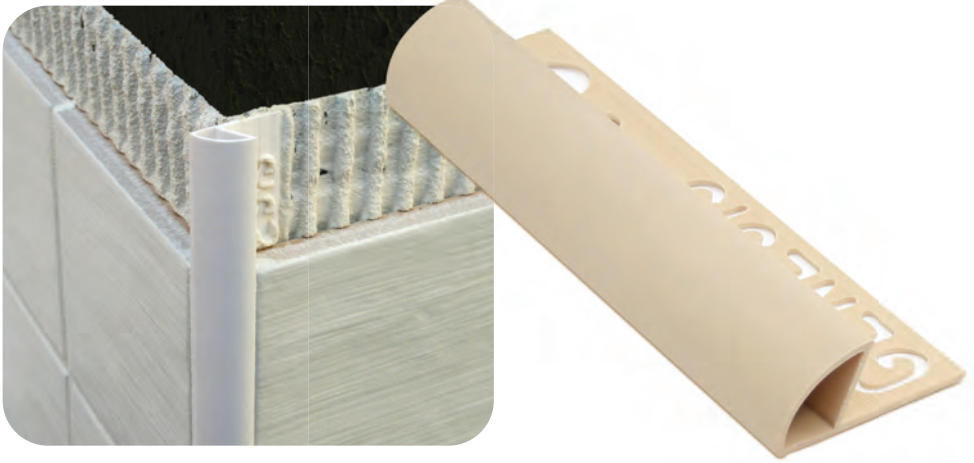

01
White



09
Caramel



10
Ivory



11
Grey

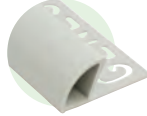

12
Peach



13
Champers



14
Buff



16
Black

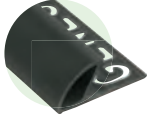

20
Brown



25
Beige



26
Cream



32
Soft Cream



34
Soft Grey

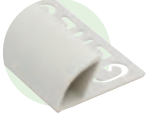

62
Brown Marble



63
Grey Marble



64
White Marble



70
Toffee Swirl



72
Roman Marble



81
Matt Silver

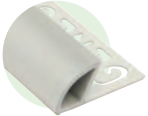

91
Bright Silver



111
Glacier White



116
Barley Marble



Internal Trim



ONLY
£5.33
each

01
White

Code	D (mm)	Length (m)	Box Qty	Price/Length
ETI090.01	9	2.5	50	£5.33

Eco Trim



FROM
£3.74
each

32
Soft Cream
see other finish
options on page 100

Code	W x D (mm)	Length (m)	Box Qty	Price/Length
ECT060.01	7 x 6 x 23	2.5	100	£3.74
ECT060.32	7 x 6 x 23	2.5	100	£3.74
ECT060.34	7 x 6 x 23	2.5	100	£3.74
ECT090.01	10 x 9 x 26	2.5	100	£3.74
ECT090.32	10 x 9 x 26	2.5	100	£3.74
ECT090.34	10 x 9 x 26	2.5	100	£3.74
ECT120.01	13 x 12 x 28	2.5	100	£3.74
ECT120.32	13 x 12 x 28	2.5	100	£3.74
ECT120.34	13 x 12 x 28	2.5	100	£3.74

PVC Dividing Strip



ONLY
£5.41
each

01
White

Code	W x D (mm)	Length (m)	Box Qty	Price/Length
TPP104.01	8 x 10	2.5	60	£5.41
TPP124.01	8 x 12	2.5	60	£5.41

Corner Pieces

Code	Packed	Box Qty	Price/Pack
PTP104.01	10mm 2 way corner x 4	50	£5.41
PTP124.01	12mm 2 way corner x 4	50	£5.41

Regular Trim plus



FROM
£1.66
each

01
White

Code	D (mm)	Length (m)	Box Qty	Price/Length
ETP908.01	9	2.5	50	£4.91

Code	D (mm)	Type	Pack Qty	Price/Pack
PCL235.01	9	Internal/ External	2 of each	£1.66



PVC Straight Edge



FROM
£1.45
each

Code	D (mm)	L(m)	Qty	Price	Box Price
ESP060.01	6	2.5	100	£3.32	£1.45
ESP060.34	6	2.5	100	£5.33	£1.85
ESP080.01	8	2.5	100	£3.32	£1.45
ESP080.11	8	2.5	100	£5.33	£1.75
ESP080.16	8	2.5	100	£5.33	£1.75
ESP080.32	8	2.5	100	£5.33	£1.75
ESP080.34	8	2.5	100	£5.33	£1.75
ESP100.01	10	2.5	100	£3.32	£1.60
ESP100.11	10	2.5	100	£5.33	£1.85
ESP100.16	10	2.5	100	£5.33	£1.85
ESP100.32	10	2.5	100	£5.33	£1.85
ESP100.34	10	2.5	100	£5.33	£1.85
ESP120.01	12	2.5	100	£3.32	£1.90
ESP120.11	12	2.5	100	£5.33	£1.90
ESP120.16	12	2.5	100	£5.33	£1.90
ESP120.32	12	2.5	100	£5.33	£1.90
ESP120.34	12	2.5	100	£5.33	£1.90
ESP150.01	15	2.5	100	£3.32	£2.25

01
White



11
Grey



16
Black



32
Soft Cream



34
Soft Grey



Seal Under / Over Tile & Seal Plus

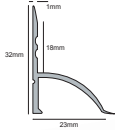
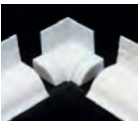

SBS180

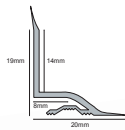

SSP180



ONLY
£1.99
each

01
White

Seal Under / Over Tile

Code	Fixing	L(m)	Qty	Price	Box Price
SBS180.01	Under / over tile	1.8	25	£4.96	£2.25
SPS180.01	Under tile only	1.8	25	£4.96	£2.25

Corner Pieces

Code	Packed	Qty	Price
SMT100.01	1 corner + 2 end caps	50 packs	£2.49

Seal Plus

Code	Fixing	L(m)	Qty	Price
SSP180.01	Under / over tile	1.8	50	£2.29

Corner Pieces

Code	Packed	Qty	Price
SMP100.01	1 corner + 2 end caps	50 packs	£1.99



Beading



ONLY
£1.99
each

01
White

Code	Fixing	Length (m)	Box Qty	Price/Length
SRP250.01	Over tile only	2.5	25	£6.99

Corner Pieces

Code	Packed	Box Qty	Price/Pack
SRE100.01	2 way external corner x 5	50	£1.99
SRI100.01	2 way internal corner x 5	50	£1.99
SRT100.01	3 way internal corner x 5	50	£1.99

Eezi Seal



ONLY
£5.83
each

01
White

Code	W x D (mm)	Length (m)	Box Qty	Price/Length
SOR335.01	15 x 15	3.5	48	£5.83

Vinyl to Tile - EVC



ONLY
£2.20
each

16
Black
see other finish
options on page 100

Code	W x D (mm)	L(m)	Qty	Price	Box Price
EVC080.01	15 x 8	2.5	50	£2.99	£2.20
EVC080.11	15 x 8	2.5	50	£2.99	£2.20
EVC080.16	15 x 8	2.5	50	£2.99	£2.20
EVC100.01	15 x 10 NEW	2.5	50	£2.99	£2.20

Retro-Fit Corner Protector



FROM
£2.91
each

01
White

Code	W x D (mm)	L (m)	Qty	Price
ERP120.01	12 x 12	2.5	50	£2.91
ERP200.01	20 x 20	2.5	50	£3.33
ERP250.01	25 x 25	2.5	50	£3.74
ERP300.01	30 x 30	2.5	25	£4.16
ERP500.01	50 x 50	2.5	25	£4.58

Vinyl to Tile - EFU



ONLY
£5.41
each

01
White

Code	W x D (mm)	L (m)	Qty	Price
EFU080.01	15 x 8	2.5	50	£5.41

Vinyl to Tile - EVT



FROM
£2.50
each

01
White

Code	W x D (mm)	L (m)	Qty	Price	Box Price
EVT080.01	15 x 8	2.5	25	£3.94	£2.50
EVT120.01	15 x 12	2.5	25	£4.84	£2.90

P.V.C. Flexible Sit On Skirting

FROM
£4.58
each

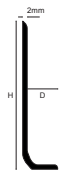

16
Black
see other finish options on page 100

Code	H x D (mm)	Length (m)	Box Qty	Price/Length
KSO100.16	100 x 20	2	30	£4.58
KSO100.43	100 x 20	2	30	£4.58
KSO1015.16	100 x 20	15 (coil)	1	£24.99
KSO1015.43	100 x 20	15 (coil)	1	£24.99
KSO150.16	150 x 20	2	20	£5.41
KSO150.43	150 x 20	2	20	£5.41

P.V.C. Flexible Cove Former

FROM
£3.33
each

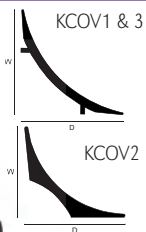

16
Black

Code	W x D (mm)	Length (m)	Box Qty	Price/Length
KCOV1.16	38 x 38	2	30	£4.16
KCOV2.16	20 x 20	2	30	£3.33
KCOV3.16	32 x 32	2	30	£4.16

P.V.C. Flexible Set In Skirting

ONLY
£6.66
each



43
Dolphin Grey
see other finish options on page 100

Code	H x D (mm)	Length (m)	Box Qty	Price/Length
KSI100.16	100 x 50	2	20	£6.66
KSI100.43	100 x 50	2	20	£6.66

P.V.C. Dim Strip

FROM
£4.58
each

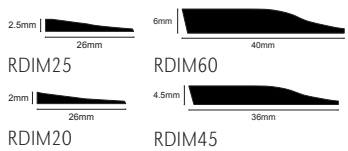

16
Black

Code	W x D (mm)	Length (m)	Box Qty	Price/Length
RDIM20.16	26 x 2	15 (coil)	10	£17.08
RDIM25.16	26 x 2.5	15 (coil)	10	£20.83
RDIM45.16	36 x 4.5	2	40	£4.58
RDIM60.16	40 x 6	2	20	£7.49

P.V.C. Capping Strip



ONLY
£4.99
each



01
White
see other finish
options on page 100

P.V.C. Capping Strip



FROM
£7.08
each



Code	W x D (mm)	Length (m)	Box Qty	Price/Length
KCS01.01	40 x 2	2	40	£4.99
KCS01.16	40 x 2	2	40	£4.99
KCS01.43	40 x 2	2	40	£4.99

Code	W x D (mm)	Length (m)	Box Qty	Price/Length
KCS02.01	39.5 x 1.5	2	40	£7.08
KCS02.16	39.5 x 1.5	2	40	£7.08
KCS022.01	39.5 x 1.5	20 (coil)	3	£43.32
KCS022.16	39.5 x 1.5	20 (coil)	3	£43.32
KCS022.43	39.5 x 1.5	20 (coil)	3	£43.71





LRV's – Clarification

Reflectance is the proportion of light that a surface reflects compared to the amount or volume of light that falls on the said surface. An LRV is a value given to a surface to identify the amount of light reflected. People with impaired vision can perceive light and dark, therefore LRV's are a suitable method to measure contrast between 2 different surfaces.

Note that dark, matt or textured surfaces absorb a large amount of light, therefore have low reflectance values, however a combination of one or all light, shiny or smooth surfaces reflect the majority of light and therefore have higher reflectance values.

In order to achieve a suitable contrast between different surfaces, ADM 2004 recommend at least a 30 point difference in the LRV's of the two contrasting surfaces.

Genesis Finish	LRV	RAL
01 White	79.9	9003
16 Black	4.5	9004
20 Brown	9.1	8014
25 Beige	41.1	1001
27 Canvas	53.2	1013
30 Red	10.6	3031
43 Dolphin Grey	27.6	7042
44 Ice Grey	42.1	7001
46 Midnight Grey	12.8	7024
47 Yellow	55.7	1018
48 Cobalt Blue	9.2	5000
54 Saffron		1017
80 Mill Aluminium	78.9	
113 Tangerine		2000
601 White	82.7	9003
616 Black	4.8	9004
643 Dolphin Grey	18.3	7000
647 Yellow	46.1	1012

Please note the RAL numbers in the above table is a guide only and cannot guarantee an exact match as there are a number of variables within the manufacturing process.

Nosing Insert Slip Resistance

Slip-resistance tests have been independently undertaken by Lucideon Ltd using the pendulum and inclined platform test.

Inclined Platform Test DIN 51130:2010

The critical angle at which a test person reaches the limit of safe walking on an inclined plane is used as a measure of slip resistance.

Pendulum Test BS 7976-2:2002

The energy absorbed by contact with the pre-set distance is read from a physical scale by a pointer that follows the overswing of the pendulum arm. 12 results are averaged to give the final pendulum number which is used to categorise the tile surface.

Results

Insert	Inclined Platform Test DIN 51130:2010*	Category	Pendulum Test BS 7976-2:2002 [†]	
			Dry	Wet
Standard	22.9°	R11	66	54
Tredsafe®	24.7°	R11	57	47

*Average of Six Shod Results (Corrected)

[†]PTV Average Value

The UK slip resistance group recommends the following guidelines;

PTV	Slip Potential
0-24	High
25-35	Moderate
36+	Low



Drilling Instructions

Drill using Genesis countersunk drill bit

Start 75mm from one end and set all holes equally as indicated for single and double channel.

Length	No. of Holes
600 - 699	2
700 - 1049	3
1050 - 1399	4
1400 - 1749	5
1750 - 2099	6
2100 - 2449	7
2450 - 2799	8
2800 - 3220	9

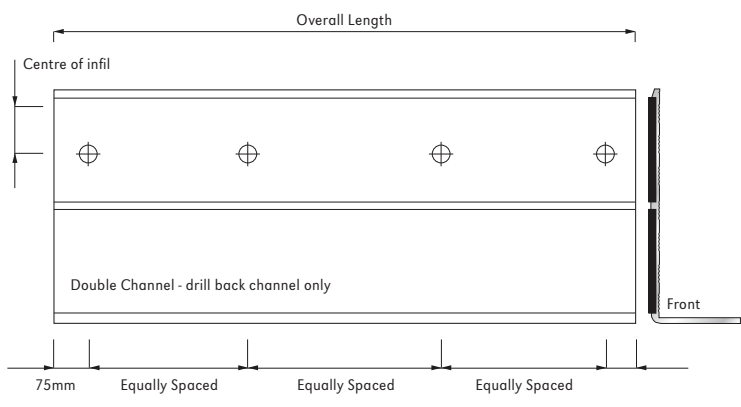
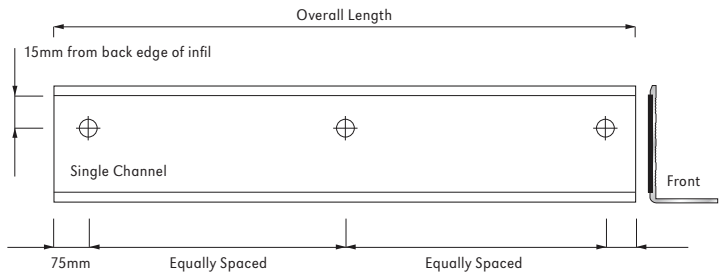
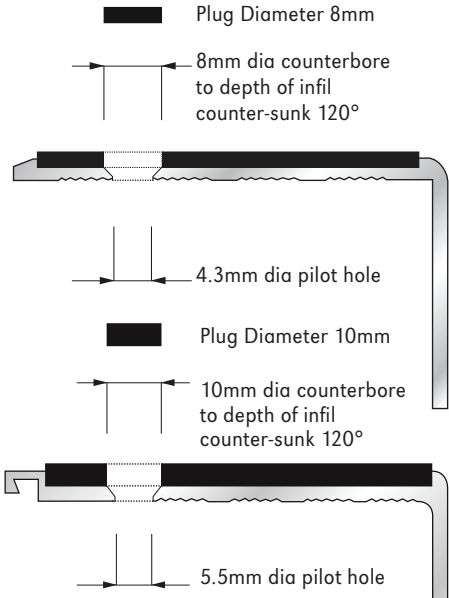

Installation - Mechanical Fix



1
Prepare surface, it must be clean, smooth and free of debris.



2
Position the profile, check the fit and mark the drill holes.



3
Drill and Plug to suit the screw size.



4
Apply adhesive as per manufacturer's instructions.



5
Position onto step.



6
Mechanically fix.



7
Insert plug.



8
Remove protective film when applicable.

If fixing inserts separate follow steps 1 – 6, remove release paper from channel and position insert ends flush applying pressure towards the centre finishing with hand roller to ensure adhesion.

Installation - Adhesive

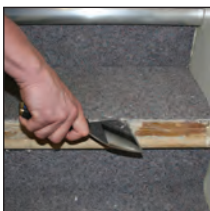

1
Prepare surface, it must be clean, smooth and free of debris.

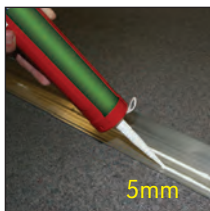

2
Apply 5mm bead to the underside of the profile, 2 lines for Single and 3 for double channel.

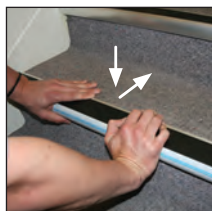

3
Position, press and slide to ensure full bond.

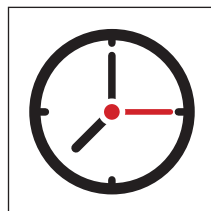

4
Allow min. 1 hour after fixing. It is the contractor's responsibility to ensure the bond is secure before opening the area.

Installer must follow individual manufacturers guidelines.

Insert quick reference guide

Insert	LRV	NSL		ASL		NHD		AHD		NTC/S	ATC/S	NXF/S	LNR	P.V.C
		SINGLE	DOUBLE	SINGLE	DOUBLE	SINGLE	DOUBLE	SINGLE	DOUBLE					
Standard														
01 White	79.9	○	○	○	○	○	○	○	○	○	○		○	○
16 Black	4.5	●	●	●	●	●	●	●	●	●	●	●	●	●
20 Brown	9.1	●	●	●	●	●	●	●	●	●	●		●	●
25 Beige	41.1	●	●	●	●	●	●	●	●	●	●		●	●
27 Canvas	53.2	○	○	○	○	○	○	○	○	○	○		○	○
30 Red	10.6	●	●	●	●	●	●	●	●	●	●		●	●
43 Dolphin Grey	27.6	●	●	●	●	●	●	●	●	●	●		●	●
44 Ice Grey	42.1	○	○	○	○	○	○	○	○	○	○	○	○	○
46 Midnight Grey	12.8	●	●	●	●	●	●	●	●	●	●		●	●
47 Yellow	55.7	●	●	●	●	●	●	●	●	●	●	●	●	●
48 Cobalt Blue	9.2	●	●	●	●	●	●	●	●	●	●		●	●
54 Saffron		●												●
113 Tangerine		●												●
120H Hazard						●	●	●	●					●
Tredsafe®														
601 White	82.7	○	○	○	○	○	○	○	○	○	○		○	○
616 Black	4.8	●	●	●	●	●	●	●	●	●	●		●	●
643 Dolphin Grey	18.2	●	●	●	●	●	●	●	●	●	●		●	●
647 Yellow	46.1	●	●	●	●	●	●	●	●	●	●		●	●
NIA50														
80 Mill Aluminium	78.9					○				○			○	
P.V.C Channel														
16 Black														●
Anodising														
16 Black		●	●	●	●	●	●	●	●			●	●	
81 Matt Silver		○	○	○	○	○	○	○	○			○	○	
86 Bright Brass		●	●	●	●	●	●	●	●			●		
91 Bright Silver		○	○	○	○	○	○	○	○			○		

Standard - NISL38



Standard - NIHD38



Tredsafe® - NITR38

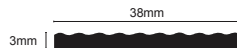

Standard - NISL50



Standard - NIHD50



Tredsafe® - NITR50

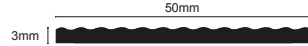

Castellated - NIA50

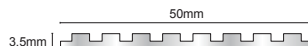

Insert	Fits	External	Price
NISL38	NSL Twin Channel	No	£1.99
NISL50	NSL Single Channel	No	£2.64
NIHD38	NHD Twin Channel	No	£3.17
NIHD50	NHD Single Channel	No	£4.18
NITR38	NSL, NHD Twin Channel	Yes	£10.40
NITR50	NSL, NHD Single Channel	Yes	£15.60
NIA50	NHD Single Channel	No	£6.24



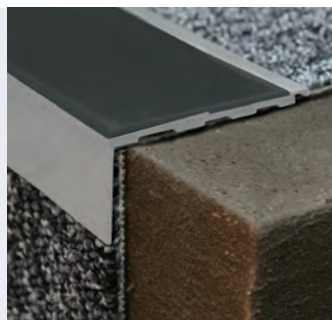

FROM
£15.86
per m

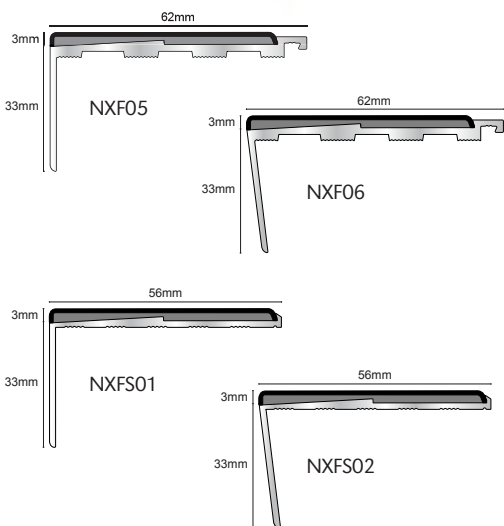

Code	W x D (mm)	Standard Price/Metre
NXF05	62 x 36	£18.46
NXF06	62 x 36	£18.46
NXFS01	56 x 36	£15.86
NXFS02	56 x 36	£15.86

Anodising Charges - Maximum length is 3m
£22.50/m. 7-10 working days
For Black (16) Matt Silver (81), Bright Brass (86)
and Bright Silver (91) Other finishes POA

Cutting & Drilling
Cutting Surcharge 5%. Drilling Surcharge 10%

Insert	LRV	NXF	N XFS
Standard			
16 Black	4.5		
44 Ice Grey	42.1		
47 Yellow	55.7		
Anodising			
16 Black			
81 Matt Silver			
86 Bright Brass			
91 Bright Silver			

NXF/S Rigid & Flexible

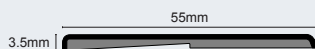

Slimline Aluminium Nosings





FROM
£9.58
per m

Code	W x D (mm)	Standard Price/Metre	Tredsafe® Price/Metre
NSL01	56 x 32	£9.58	£18.74
NSL02	57 x 32	£9.58	£18.74
NSL03	57 x 40	£11.24	£20.41
NSL09	85 x 32	£13.10	£25.58
NSL10	85 x 32	£13.10	£25.58
NSL15	66 x 32	£10.83	£19.99
NSL16	66 x 32	£10.83	£19.99
NSL19	56 x 55	£10.83	£19.99
NSL20	57 x 55	£10.83	£19.99
NSL21	67 x 55	£11.66	£20.83
NSL25	69 x 40	£11.66	£20.83
NSL26	67 x 55	£11.66	£20.83
NSL27	69 x 55	£14.16	£32.08
NSL28	69 x 55	£14.16	£32.08
NSL29	87 x 40	£14.58	£26.99

Available in 2.46m, 2.77m, 3.22m Standard Lengths. *3m Standard Lengths

Anodising Charges - Maximum length is 3m
£22.50/m. 7-10 working days
For Black (16) Matt Silver (81), Bright Brass (86)
and Bright Silver (91)
Other finishes POA

Curving Charges - 7-10 working days
CF-SHS Single Hockey Stick: £187.50 each
CF-DHS Double Hockey Stick: £300.00 each
CF-CC Continuous Curve: £225.00 per metre
CF-WM Welded Mitres: £52.50 per metre

Cutting & Drilling
Cutting Surcharge 5%. Drilling Surcharge 10%



Insert	LRV	SINGLE	DOUBLE
Standard			
01 White	79.9		
16 Black	4.5		
20 Brown	9.1		
25 Beige	41.1		
27 Canvas	53.2		
30 Red	10.6		
43 Dolphin Grey	27.6		
44 Ice Grey	42.1		
46 Midnight Grey	12.8		
47 Yellow	55.7		
48 Cobalt Blue	9.2		
54 Saffron			
113 Tangerine			
Tredsafe®			
601 White	82.7		
616 Black	4.8		
643 Dolphin Grey	18.2		
647 Yellow	46.1		
Anodising			
16 Black			
81 Matt Silver			
86 Bright Brass			
91 Bright Silver			

Standard



Tredsafe®

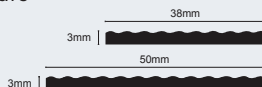

Aluminator® Slimline Aluminium Nosings

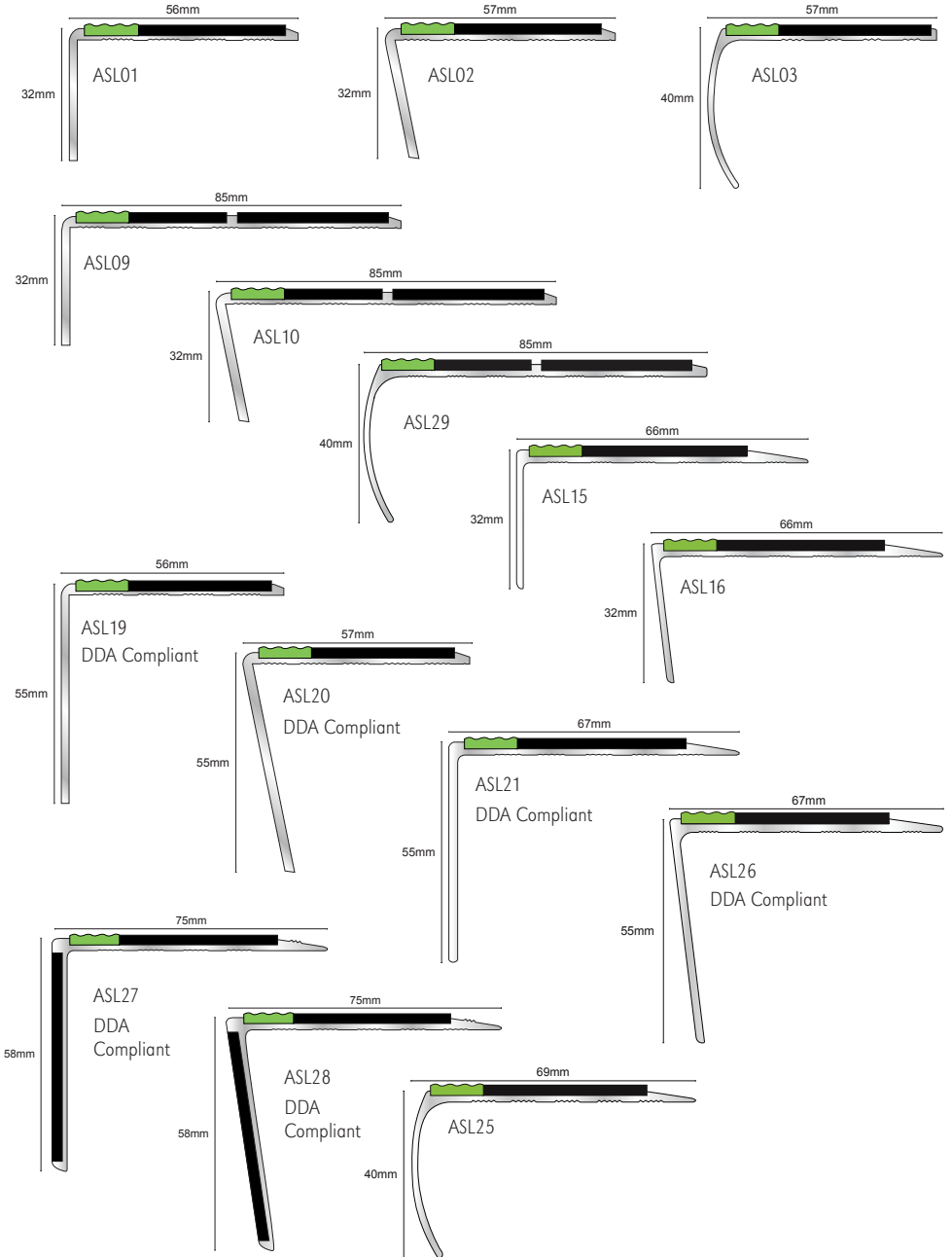



FROM
£27.49
per m

Code	W x D (mm)	Standard Price/Metre	Tredsafe® Price/Metre
ASL01	56 x 32	£27.49	£39.16
ASL02	57 x 32	£27.49	£39.16
ASL03	57 x 40	£29.16	£41.24
ASL09	85 x 32	£32.91	£48.33
ASL10	85 x 32	£32.91	£48.33
ASL15	66 x 32	£29.38	£40.82
ASL16	66 x 32	£29.38	£40.82
ASL19	56 x 55	£29.12	£40.56
ASL20	57 x 55	£29.12	£40.56
ASL21	67 x 55	£30.68	£42.12
ASL25	69 x 40	£30.68	£42.12
ASL26	67 x 55	£31.46	£42.90
ASL27	69 x 55	£33.28	£56.16
ASL28	69 x 55	£33.28	£56.16
ASL29	87 x 40	£35.10	£50.70

Available in 2.46m, 2.77m, 3.22m Standard Lengths.

Anodising Charges - Maximum length is 3m
£22.50/m. 7-10 working days
For Black (16) Matt Silver (81), Bright Brass (86)
and Bright Silver (91)
Other finishes POA

Curving Charges - 7-10 working days
CF-SHS Single Hockey Stick: £187.50 each
CF-DHS Double Hockey Stick: £300.00 each
CF-CC Continuous Curve: £225.00 per metre
CF-WM Welded Mitres: £52.50 per metre

Cutting & Drilling
Cutting Surcharge 5%. Drilling Surcharge 10%

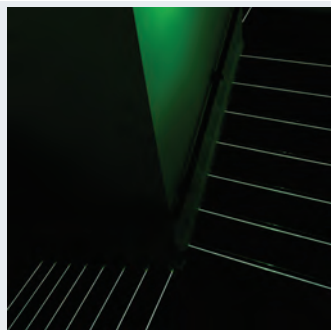

Insert	LRV	SINGLE	DOUBLE
Standard			
01 White	79.9		
16 Black	4.5		
20 Brown	9.1		
25 Beige	41.1		
27 Canvas	53.2		
30 Red	10.6		
43 Dolphin Grey	27.6		
44 Ice Grey	42.1		
46 Midnight Grey	12.8		
47 Yellow	55.7		
48 Cobalt Blue	9.2		
Tredsafe®			
601 White	82.7		
616 Black	4.8		
643 Dolphin Grey	18.2		
647 Yellow	46.1		
Anodising			
16 Black			
81 Matt Silver			
86 Bright Brass			
91 Bright Silver			

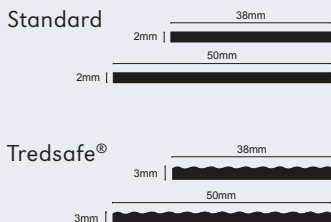

Heavy Duty Aluminium Nosings

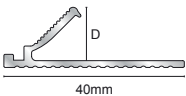
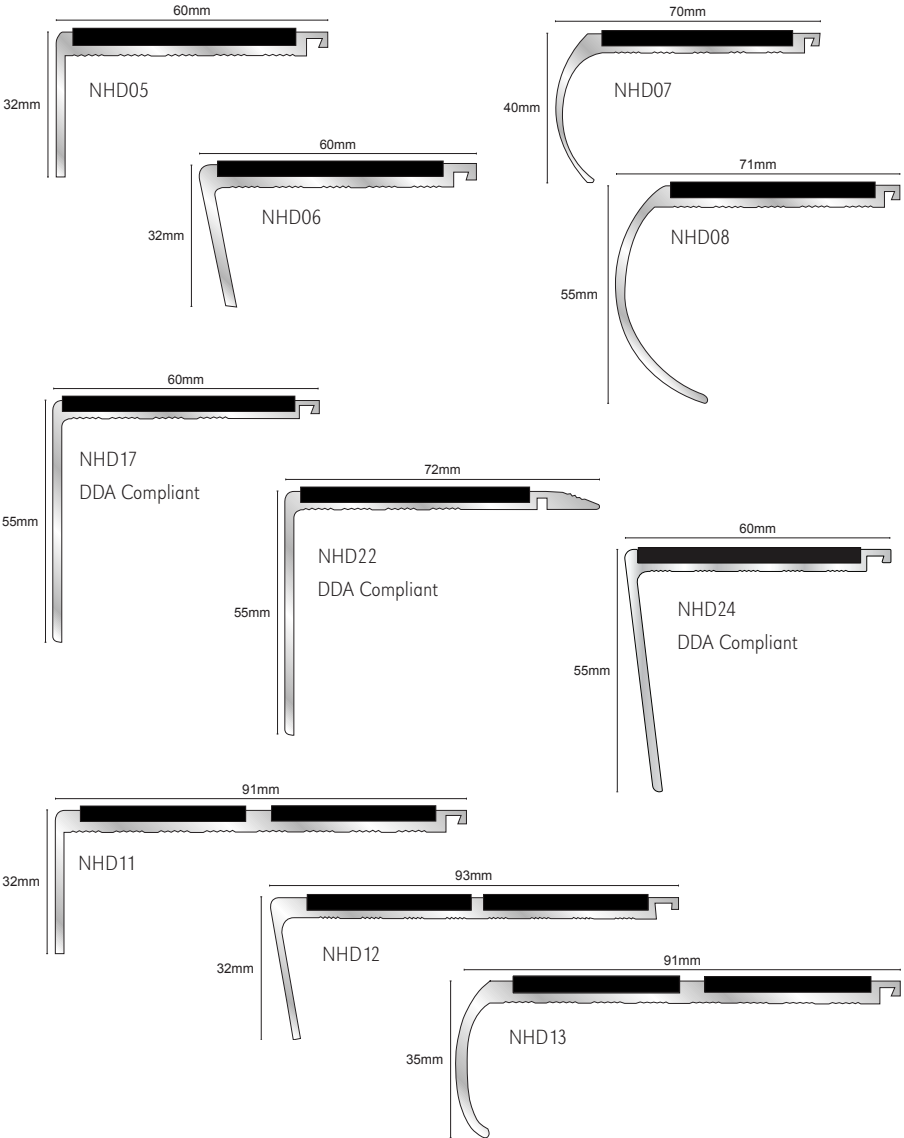

NNL01 Carpet Connector

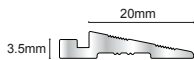

NNL02 Ramp Connector



FROM
£14.58
per m

Code	W x D (mm)	Standard Price/Metre	Tredsafe® Price/Metre
NHD05	60 x 32	£14.58	£26.24
NHD06	63 x 32	£14.58	£26.24
NHD07	70 x 40	£16.66	£28.33
NHD08	71 x 55	£17.91	£29.58
NHD11	91 x 32	£18.74	£34.58
NHD12	93 x 32	£18.74	£34.58
NHD13	91 x 35	£20.83	£26.66
NHD17	60 x 55	£15.83	£27.49
NHD22	72 x 55	£17.49	£29.58
NHD24	60 x 55	£15.83	£27.49
NNL01*	40 x 10	£3.74	-
NNL02*	20 x 3.5	£3.33	-

Available in 2.46m, 2.77m, 3.22m Standard Lengths. * 3.22m Standard Lengths

Anodising Charges - Maximum length is 3m
£22.50/m. 7-10 working days
For Black (16) Matt Silver (81), Bright Brass (86)
and Bright Silver (91)
Other finishes POA

Curving Charges - 7-10 working days
CF-SHS Single Hockey Stick: £187.50 each
CF-DHS Double Hockey Stick: £300.00 each
CF-CC Continuous Curve: £225.00 per metre
CF-WM Welded Mitres: £52.50 per metre

Cutting & Drilling
Cutting Surcharge 5%. Drilling Surcharge 10%



Insert LRV SINGLE DOUBLE

Standard

01 White	79.9	<input type="checkbox"/>	<input type="checkbox"/>
16 Black	4.5	<input checked="" type="checkbox"/>	<input checked="" type="checkbox"/>
20 Brown	9.1	<input type="checkbox"/>	<input type="checkbox"/>
25 Beige	41.1	<input type="checkbox"/>	<input type="checkbox"/>
27 Canvas	53.2	<input type="checkbox"/>	<input type="checkbox"/>
30 Red	10.6	<input checked="" type="checkbox"/>	<input checked="" type="checkbox"/>
43 Dolphin Grey	27.6	<input type="checkbox"/>	<input type="checkbox"/>
44 Ice Grey	42.1	<input type="checkbox"/>	<input type="checkbox"/>
46 Midnight Grey	12.8	<input type="checkbox"/>	<input type="checkbox"/>
47 Yellow	55.7	<input checked="" type="checkbox"/>	<input checked="" type="checkbox"/>
48 Cobalt Blue	9.2	<input type="checkbox"/>	<input type="checkbox"/>
102H Hazard		<input checked="" type="checkbox"/>	<input checked="" type="checkbox"/>

Tredsafe®

601 White	82.7	<input type="checkbox"/>	<input type="checkbox"/>
616 Black	4.8	<input checked="" type="checkbox"/>	<input checked="" type="checkbox"/>
643 Dolphin Grey	18.2	<input type="checkbox"/>	<input type="checkbox"/>
647 Yellow	46.1	<input checked="" type="checkbox"/>	<input checked="" type="checkbox"/>

NIA50

80 Mill Aluminium	78.9	<input type="checkbox"/>	<input type="checkbox"/>
-------------------	------	--------------------------	--------------------------

Anodising

16 Black	<input checked="" type="checkbox"/>	<input checked="" type="checkbox"/>
81 Matt Silver	<input type="checkbox"/>	<input type="checkbox"/>
86 Bright Brass	<input type="checkbox"/>	<input type="checkbox"/>
91 Bright Silver	<input type="checkbox"/>	<input type="checkbox"/>

Standard

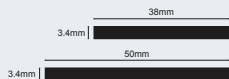

Tredsafe®

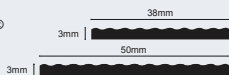

NIA50



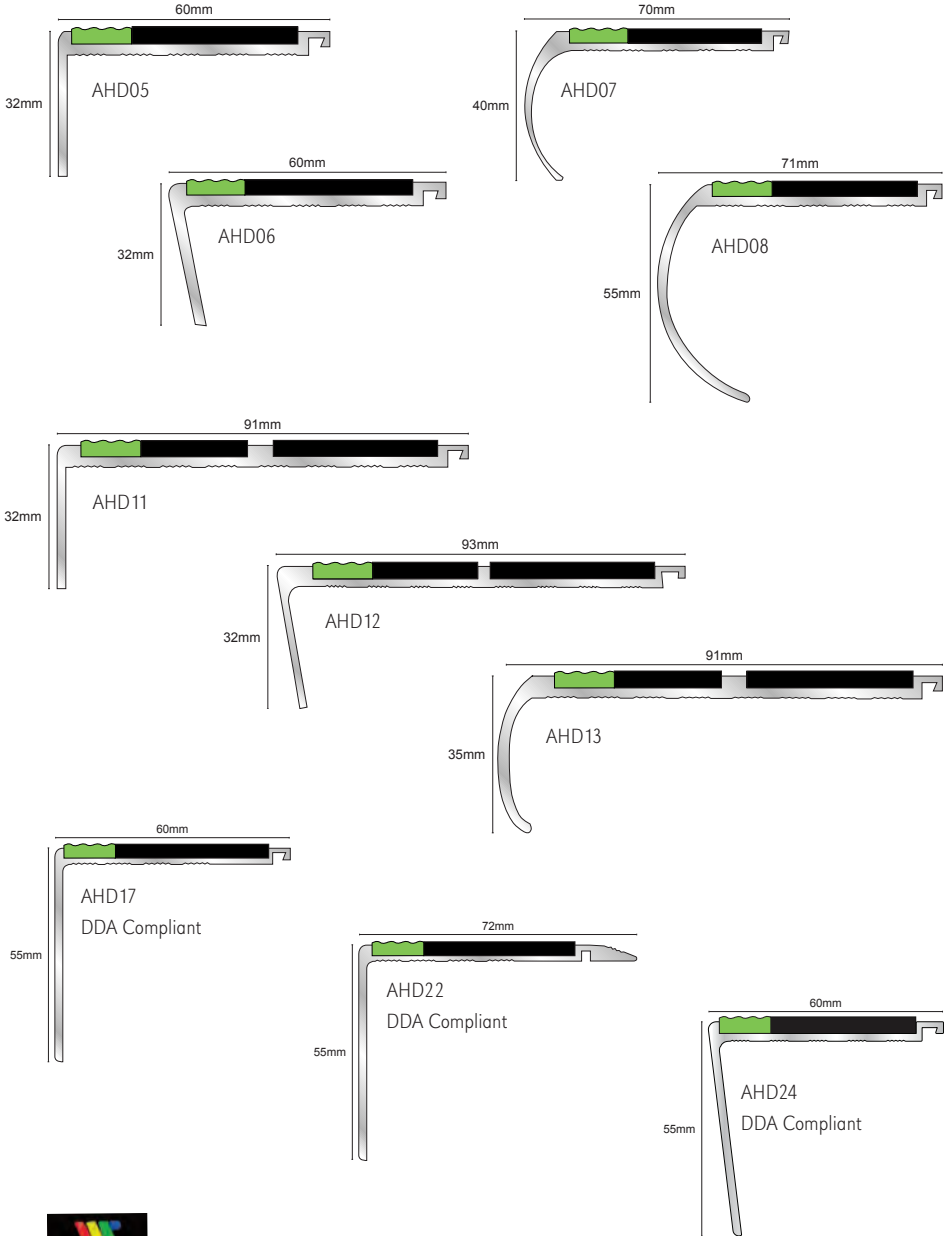

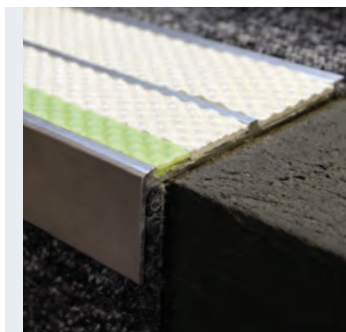

FROM
£30.41
per m

Code	W x D (mm)	Standard Price/Metre	Tredsafe® Price/Metre
AHD05	60 x 32	£30.41	£41.66
AHD06	63 x 32	£30.41	£41.66
AHD07	70 x 40	£32.49	£43.74
AHD08	71 x 55	£33.74	£44.99
AHD11	91 x 32	£35.41	£51.24
AHD12	93 x 32	£35.41	£51.24
AHD13	91 x 35	£37.49	£53.33
AHD17	60 x 55	£31.66	£44.58
AHD22	72 x 55	£32.91	£44.88
AHD24	60 x 55	£31.66	£44.58

Available in 2.46m, 2.77m, 3.22m Standard Lengths. *3m Standard Lengths

Anodising Charges - Maximum length is 3m
£22.50/m. 7-10 working days
For Black (16) Matt Silver (81), Bright Brass (86)
and Bright Silver (91)
Other finishes POA

Curving Charges - 7-10 working days
CF-SHS Single Hockey Stick: £187.50 each
CF-DHS Double Hockey Stick: £300.00 each
CF-CC Continuous Curve: £225.00 per metre
CF-WM Welded Mitres: £52.50 per metre

Cutting & Drilling
Cutting Surcharge 5%. Drilling Surcharge 10%

Insert LRV SINGLE DOUBLE

Standard

01 White	79.9	<input type="checkbox"/>	<input type="checkbox"/>
16 Black	4.5	<input type="checkbox"/>	<input type="checkbox"/>
20 Brown	9.1	<input type="checkbox"/>	<input type="checkbox"/>
25 Beige	41.1	<input type="checkbox"/>	<input type="checkbox"/>
27 Canvas	53.2	<input type="checkbox"/>	<input type="checkbox"/>
30 Red	10.6	<input type="checkbox"/>	<input type="checkbox"/>
43 Dolphin Grey	27.6	<input type="checkbox"/>	<input type="checkbox"/>
44 Ice Grey	42.1	<input type="checkbox"/>	<input type="checkbox"/>
46 Midnight Grey	12.8	<input type="checkbox"/>	<input type="checkbox"/>
47 Yellow	55.7	<input type="checkbox"/>	<input type="checkbox"/>
48 Cobalt Blue	9.2	<input type="checkbox"/>	<input type="checkbox"/>
120H Hazard		<input type="checkbox"/>	<input type="checkbox"/>

Tredsafe®

601 White	82.7	<input type="checkbox"/>	<input type="checkbox"/>
616 Black	4.8	<input type="checkbox"/>	<input type="checkbox"/>
643 Dolphin Grey	18.2	<input type="checkbox"/>	<input type="checkbox"/>
647 Yellow	46.1	<input type="checkbox"/>	<input type="checkbox"/>

Anodising

16 Black	<input type="checkbox"/>	<input type="checkbox"/>
81 Matt Silver	<input type="checkbox"/>	<input type="checkbox"/>
86 Bright Brass	<input type="checkbox"/>	<input type="checkbox"/>
91 Bright Silver	<input type="checkbox"/>	<input type="checkbox"/>

Standard



Tredsafe®

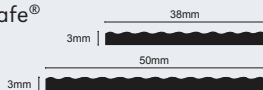

Hard Nose P.V.C

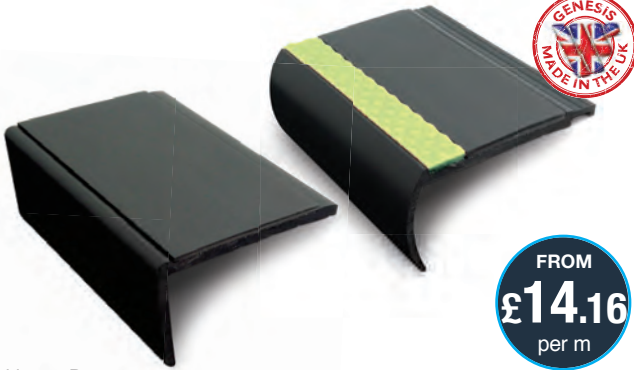

Heavy Duty

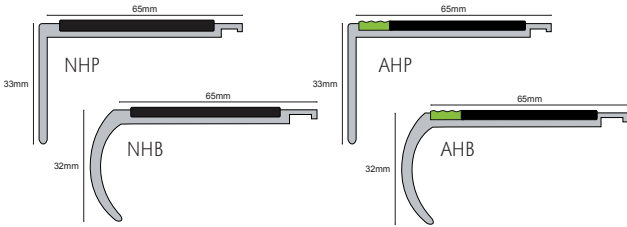

Slimline

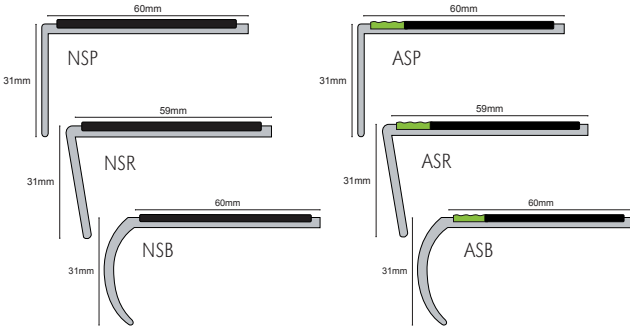

Heavy Duty

Code	D (mm)	Standard Price/Metre	Tredsafe® Price/Metre
NHP	65 x 33	£14.16	£25.41
NHB	65 x 32	£14.16	£25.41
AHP	65 x 33	£27.49	£41.24
AHB	65 x 32	£27.49	£41.24

Slimline

NSP	60 x 31	£11.24	£22.49
NSR	59 x 31	£11.24	£22.49
NSB	60 x 31	£11.24	£22.49
ASP	60 x 31	£31.66	£38.33
ASR	59 x 31	£31.66	£38.33
ASB	60 x 31	£31.66	£38.33

Available in 3.22m lengths

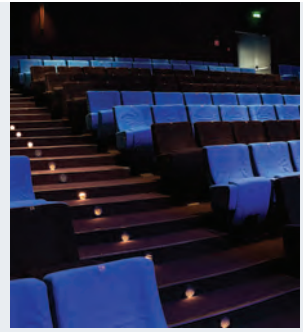

Insert LRV SLIM HD

Standard

01 White	79.9	<input type="checkbox"/>	<input type="checkbox"/>
16 Black	4.5	<input checked="" type="checkbox"/>	<input checked="" type="checkbox"/>
20 Brown	9.1	<input checked="" type="checkbox"/>	<input checked="" type="checkbox"/>
25 Beige	41.1	<input checked="" type="checkbox"/>	<input checked="" type="checkbox"/>
27 Canvas	53.2	<input checked="" type="checkbox"/>	<input checked="" type="checkbox"/>
30 Red	10.6	<input checked="" type="checkbox"/>	<input checked="" type="checkbox"/>
43 Dolphin Grey	27.6	<input checked="" type="checkbox"/>	<input checked="" type="checkbox"/>
44 Ice Grey	42.1	<input checked="" type="checkbox"/>	<input checked="" type="checkbox"/>
46 Midnight Grey	12.8	<input checked="" type="checkbox"/>	<input checked="" type="checkbox"/>
47 Yellow	55.7	<input checked="" type="checkbox"/>	<input checked="" type="checkbox"/>
48 Cobalt Blue	9.2	<input checked="" type="checkbox"/>	<input checked="" type="checkbox"/>
54 Saffron		<input checked="" type="checkbox"/>	
113 Tangerine		<input checked="" type="checkbox"/>	
120H Hazard			<input checked="" type="checkbox"/>

Tredsafe®

601 White	82.7	<input checked="" type="checkbox"/>	<input checked="" type="checkbox"/>
616 Black	4.8	<input checked="" type="checkbox"/>	<input checked="" type="checkbox"/>
643 Dolphin Grey	18.2	<input checked="" type="checkbox"/>	<input checked="" type="checkbox"/>
647 Yellow	46.1	<input checked="" type="checkbox"/>	<input checked="" type="checkbox"/>

P.V.C Channel

16 Black	<input checked="" type="checkbox"/>	<input checked="" type="checkbox"/>
----------	-------------------------------------	-------------------------------------

Standard

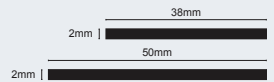

Tredsafe®

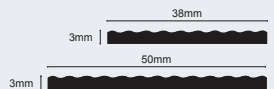

External Nosing



FROM
£13.33
per m

Code	W x D (mm)	Price/Metre
AHD23	68 x 33	£20.83
NSL23	68 x 33	£13.33

Available in 2.77m & 3.00m Standard Lengths.

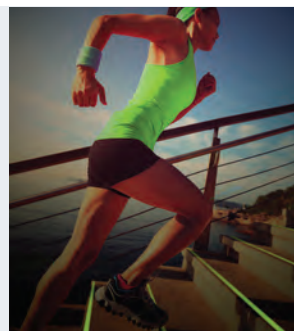

Insert	LRV	NSL /AHD
Silicone Carbide		
16 Black	4.5	
47 Yellow	55.7	

NEW Stainless Steel Tread Plates



Code	W x L (mm)	Price/Each
NTP063.16	63 x 635	£29.58
NTP063.47	63 x 635	£29.58
NTP115.16	115 x 635	£46.66
NTP115.47	115 x 635	£46.66

NEW Silicone Carbide Safety Strip



Code	W x L (mm)	Price/Each
NIW250.16	25 x 1830 roll	£30.83
NIW250.47	25 x 1830 roll	£30.83
NIW250.120	25 x 1830 roll	£30.83
NIW500.16	50 x 1830 roll	£62.49
NIW500.47	50 x 1830 roll	£62.49
NIW500.120	50 x 1830 roll	£62.49

Stair Edge Trim Pre-Formed / Landing Strip

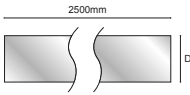
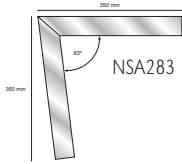
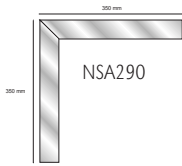

Front Face

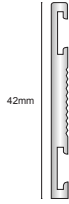

Side Profile

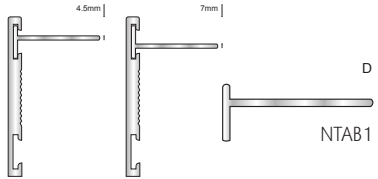

Side Profile of NSA/NTL with NTAB1

Code	D (mm)	Length (mm)	Style	Box Qty	Price/Angle
NSA290.16	42	350	Straight	10	£8.83
NSA290.80	42	350	Straight	10	£8.83
NSA283.16	42	350	Rakeback	10	£8.83
NSA283.80	42	350	Rakeback	10	£8.83

Code	D (mm)	Length (mm)	Style	Box Qty	Price/Length
NTL1.16	42	2500		10	£19.16
NTL1.80	42	2500		10	£19.16

Code	D (mm)	Pack Qty	Price/Pack	
NTAB1	4.5 / 7	Dual Height	20	£6.66



Templates/Curves

Stair casings can be made to fit most irregular shapes and curves. However each curved step must be treated individually and a separate template made for each using card, felt or paper. Follow these three simple steps as an easy guide to the perfect edge.

Step 1

Place the card or felt on top of the curve that requires a template and draw a line underneath with a felt pen or marker (see Figure 1) following the edge of the curve to create a smooth line.

Step 2

Cut the shape along the felt pen mark (Figure 2) and clearly indicate the top and front edge of the template.

Step 3

Clearly mark on the template, the customer name and reference, the profile required, the colour insert required and finally whether your curve is required drilled or undrilled (Figure 3).

For assistance with any aspect of measuring or making templates please speak to Technical Services.

Not available for NXF/S, NTC, ATC or Vision

Figure 1

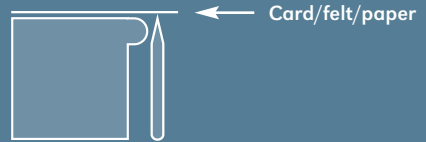

Side view of stair

Figure 2



Figure 3

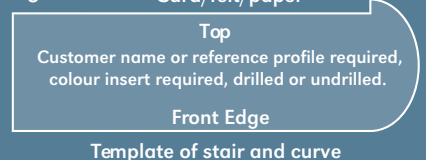

Ceramic Tile-In Edges

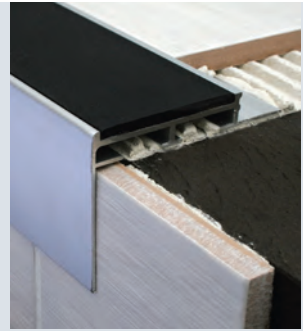

81
Matt Silver

Heavy Duty
Available in 3.22m Standard Lengths.

FROM
£12.08
per m

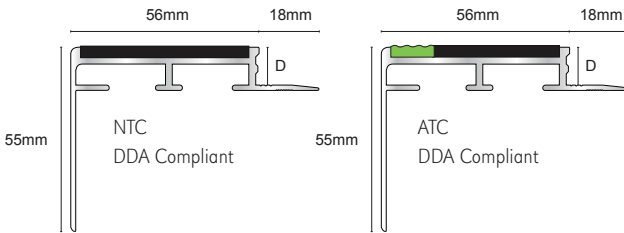

Code	D (mm)	Length (m)	Box Qty	Standard Price/Metre	Tredsafe® Price/Metre
NTC10322	10	3.22	10	£20.99	£31.99
NTC12322	12.5	3.22	10	£22.08	£32.91
ATC10322	10	3.22	10	£35.83	£62.49
ATC12322	12.5	3.22	10	£37.08	£63.32

Slimline

Available in 2.88m Standard Lengths.

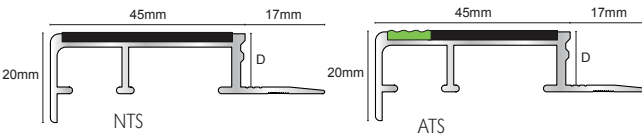

Code	D (mm)	Length (m)	Box Qty	Standard Price/Metre	Tredsafe® Price/Metre
NTS108	10	2.8	10	£12.08	£20.83
NTS128	12.5	2.8	10	£12.49	£21.24
ATS108	10	2.8	10	£36.66	£49.58
ATS128	12.5	2.8	10	£37.91	£49.99

Insert	LRV	SLIM	HD
Standard			
01 White	79.9	<input type="checkbox"/>	<input type="checkbox"/>
16 Black	4.5	<input checked="" type="checkbox"/>	<input checked="" type="checkbox"/>
20 Brown	9.1	<input checked="" type="checkbox"/>	<input checked="" type="checkbox"/>
25 Beige	41.1	<input type="checkbox"/>	<input type="checkbox"/>
27 Canvas	53.2	<input type="checkbox"/>	<input type="checkbox"/>
30 Red	10.6	<input checked="" type="checkbox"/>	<input checked="" type="checkbox"/>
43 Dolphin Grey	27.6	<input type="checkbox"/>	<input type="checkbox"/>
44 Ice Grey	42.1	<input type="checkbox"/>	<input type="checkbox"/>
46 Midnight Grey	12.8	<input type="checkbox"/>	<input type="checkbox"/>
47 Yellow	55.7	<input checked="" type="checkbox"/>	<input checked="" type="checkbox"/>
48 Cobalt Blue	9.2	<input checked="" type="checkbox"/>	<input checked="" type="checkbox"/>
120H Hazard*		<input checked="" type="checkbox"/>	<input checked="" type="checkbox"/>
Tredsafe®			
601 White	82.7	<input type="checkbox"/>	<input type="checkbox"/>
616 Black	4.8	<input checked="" type="checkbox"/>	<input checked="" type="checkbox"/>
643 Dolphin Grey	18.2	<input checked="" type="checkbox"/>	<input checked="" type="checkbox"/>
647 Yellow	46.1	<input checked="" type="checkbox"/>	<input checked="" type="checkbox"/>
NIA50*			
80 Mill Aluminium	78.9	<input type="checkbox"/>	<input type="checkbox"/>

*NTC Only

Standard

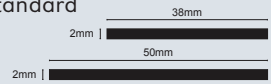

Tredsafe®

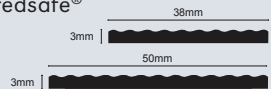

NIA50



Aluminium Stair Grip + PVC Top & End Caps



FROM
£27.49
each

16
Black

see other finish options on page 100

Code	W x D (mm)	Length (m)	Box Qty	Price/Length
NIB106.16	30 x 10	2.5	10	£27.49
NIB106.35	30 x 10	2.5	10	£27.49
NIB126.16	30 x 12	2.5	10	£29.16
NIB126.35	30 x 12	2.5	10	£29.16

End Caps

Code	Description	Pack Qty	Price
NUC102.16	Pair of universal end caps	2	£9.99
NUC102.35	Pair of universal end caps	2	£9.99

Aluminium Self Adhesive Retro-Fit



FROM
£3.74
each

40
Oak

see other finish options on page 100

Code	W x D (mm)	Length (m)	Box Qty	Price/Length
NAS207.40	30 x 20	2.7	10	£16.66
NAS207.81	30 x 20	2.7	10	£11.24
NAS207.83	30 x 20	2.7	10	£11.24
NAS209.40	30 x 20	0.9	10	£5.83
NAS209.81	30 x 20	0.9	10	£4.16
NAS209.83	30 x 20	0.9	10	£4.16
NAS107.40	25 x 10	2.7	10	£15.48
NAS107.81	25 x 10	2.7	10	£10.83
NAS107.83	25 x 10	2.7	10	£10.83
NAS109.40	25 x 10	0.9	10	£5.41
NAS109.81	25 x 10	0.9	10	£5.41
NAS109.83	25 x 10	0.9	10	£3.74

Aluminium Tile-In with Carbide Insert



FROM
£24.58
each



81
Matt Silver

Code	D (mm)	Length (m)	Box Qty	Price/Length
NLC106	10	2.6	10	£24.58
NLC126	12.5	2.6	10	£24.99

Stainless Steel Tile-In Nosing

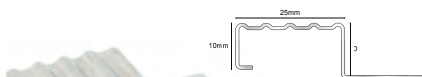

FROM
£27.91
each



84
Stainless Steel

Code	D (mm)	Length (m)	Box Qty	Price/Length
NSS106.84	10	2.5	10	£27.91
NSS126.84	12	2.5	10	£28.74

Aluminium Tile-In Step Edge



FROM
£10.83
each



81
Matt Silver

Code	W x D (mm)	Length (m)	Box Qty	Price/Length
NLT108.81	19 x 10	2.8	10	£10.83
NLT128.81	19 x 12.5	2.8	10	£11.66

Aluminium Tile-In



FROM
£19.58
each

81
Matt Silver

Code	W x D (mm)	Length (m)	Box Qty	Price/Length
NLM103.81	26 x 10	3	10	£19.58
NLM123.81	26 x 12	3	10	£19.99

Aluminium Tile-In Bullnose



FROM
£11.66
each

81
Matt Silver
see other finish options on page 100

Code	D (mm)	Length (m)	Box Qty	Price/Length
NAT105.81	10	2.6	20	£11.66
NAT105.91	10	2.6	20	£16.66
NAT125.81	12	2.6	20	£12.49
NAT125.91	12	2.6	20	£17.49

Aluminium Retro-Fit



ONLY
£12.91
each

80
Mill Aluminium

Code	W x D (mm)	Length (m)	Box Qty	Price/Length
NRA50.80	50 x 30	2.77	10	£12.91

Aluminium Nosing with Black Rubber Insert



ONLY
£27.49
each

16
Black

Code	W x D (mm)	Length (m)	Box Qty	Price/Length
NRE05.16	54 x 30	2.7	10	£27.49

Aluminium Formable 2 in 1



FROM
£12.08
each

91
Bright Silver
see other finish options on page 100

Code	W x D (mm)	Length (m)	Box Qty	Price/Length
NFA125.81	3 x 10/12	2.6	20	£12.08
NFA125.91	3 x 10/12	2.6	20	£18.33

81 Vision - Nosing

81
Matt Silver



FROM
£17.08
per m

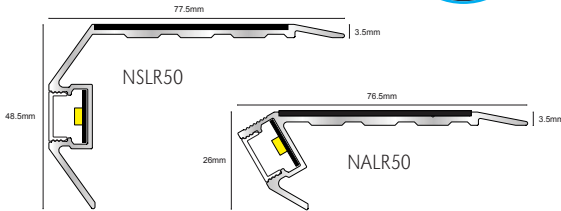

Vision - Light Down

Code	W x D (mm)	Standard Price/Metre	Tredsafe® Price/Metre
NALR508.81	76.5 x 26	£17.08	£29.58

Available in 2.8m Standard Lengths.

End Caps

Code	Description	Price/Pack
NECR508.81	End caps x 2	£13.33

Vision - Light Out

Code	W x D (mm)	Standard Price/Metre	Tredsafe® Price/Metre
NSLR508.81	77.5 x 48.5	£19.16	£31.66

Available in 2.8m Standard Lengths.

End Caps

Code	Description	Price/Pack
NECS50.81	End caps x 2	£13.33

Cutting & Drilling

Cutting Surcharge 5%. Drilling Surcharge 10%

Lighting system sold separately (page 72) - not included in price

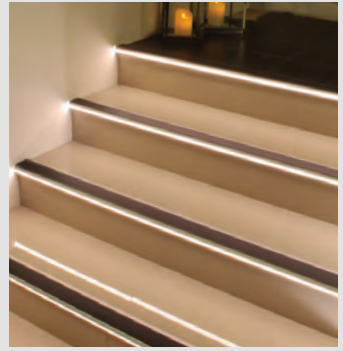

Insert	LRV	NSLR	NALR
--------	-----	------	------

Standard

01 White	79.9	<input type="checkbox"/>	<input type="checkbox"/>
16 Black	4.5	<input type="checkbox"/>	<input type="checkbox"/>
20 Brown	9.1	<input type="checkbox"/>	<input type="checkbox"/>
25 Beige	41.1	<input type="checkbox"/>	<input type="checkbox"/>
27 Canvas	53.2	<input type="checkbox"/>	<input type="checkbox"/>
30 Red	10.6	<input type="checkbox"/>	<input type="checkbox"/>
43 Dolphin Grey	27.6	<input type="checkbox"/>	<input type="checkbox"/>
44 Ice Grey	42.1	<input type="checkbox"/>	<input type="checkbox"/>
46 Midnight Grey	12.8	<input type="checkbox"/>	<input type="checkbox"/>
47 Yellow	55.7	<input type="checkbox"/>	<input type="checkbox"/>
48 Cobalt Blue	9.2	<input type="checkbox"/>	<input type="checkbox"/>
54 Saffron		<input type="checkbox"/>	<input type="checkbox"/>
113 Tangerine		<input type="checkbox"/>	<input type="checkbox"/>

Tredsafe®

601 White	82.7	<input type="checkbox"/>	<input type="checkbox"/>
616 Black	4.8	<input type="checkbox"/>	<input type="checkbox"/>
643 Dolphin Grey	18.2	<input type="checkbox"/>	<input type="checkbox"/>
647 Yellow	46.1	<input type="checkbox"/>	<input type="checkbox"/>

Channel

81 Matt Silver	<input type="checkbox"/>	<input type="checkbox"/>
----------------	--------------------------	--------------------------

Standard

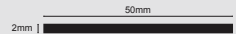

Tredsafe®

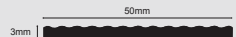

Vision - Step

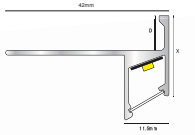
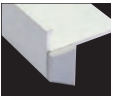

FROM
£25.41
each

81
Matt Silver

Code	D x X (mm)	Length (m)	Box Qty	Price/Length
NLD908.81	9 x 20	2.8	10	£25.41
NLD118.81	11 x 22	2.8	10	£25.83

End Caps

Code	Size (mm)	Pack Qty	Price/Pack
NPC100.81	10	2	£11.24

Vision - MultiFix

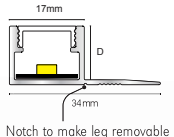

Notch to make leg removable



FROM
£20.83
each

81
Matt Silver

Code	D (mm)	Length (m)	Box Qty	Price/Length
TLD108.81	10	2.8	10	£20.83
TLD128.81	12	2.8	10	£21.66

End Caps

Code	Size (mm)	Pack Qty	Price/Pack
TUC100.81	10	2	£11.24

Vision - Skirting

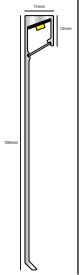

FROM
£36.24
each

81
Matt Silver
see other finish options on page 100

Code	W x D (mm)	Length (m)	Box Qty	Price/Length
KLD118.81	100 x 11	2.8	10	£36.24
KLD118.94	100 x 11	2.8	10	£41.24

End Caps

Code	Size (mm)	Pack Qty	Price/Pack
NPC100.81	10	2	£11.24
NPC100.94	10	2	£11.24



Lighting system sold separately (page 72)
- not included in price

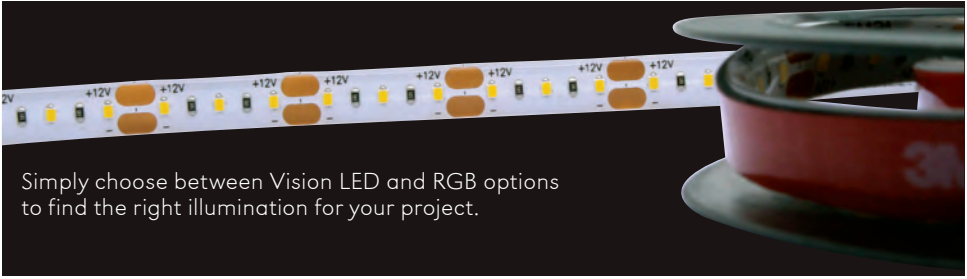

Simply choose between Vision LED and RGB options to find the right illumination for your project.

LED System



Warm 3000K Natural 4000K Cool 6000K

Safe and secure with 12V IP65 protection class as standard and premium 4.8W or 9.6W 120 LED's per metre. Available in 4000K, or to achieve the optimal effect, our CCT option offers 3000K, 4000K and 6000K in a single length.

Code	Description	Box Qty	Price/Length
LD12481.NW	4.8W 1MTR 4000K NEW	1	£30.41
LD12961.NW	9.6W 1MTR 4000K NEW	1	£36.66
LD12482.NW	4.8W 2MTR 4000K NEW	1	£49.58
LD12962.NW	9.6W 2MTR 4000K NEW	1	£57.49
LD12483.NW	4.8W 3MTR 4000K	1	£68.74
LD12963.NW	9.6W 3MTR 4000K	1	£76.66
LD12484.NW	4.8W 4MTR 4000K NEW	1	£84.16
LD12964.NW	9.6W 4MTR 4000K NEW	1	£99.58
LD12485.NW	4.8W 5MTR 4000K	1	£92.08
LD12965.NW	9.6W 5MTR 4000K	1	£111.24

Code	Description	Box Qty	Price/Length
LCT12965	9.6W 5MTR CCT Multiple White Warm (3000K), Natural (4000K), Cold (6000K)	1	£131.66

RGB System

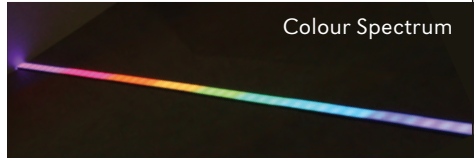

Colour Spectrum

This dynamic system offers a range of mood lighting powered by 12V IP65 protection, the 60 LED per metre powers varying colours with remote colour changing and dimming within a maximum of 4 Zones.

RGB is 14.4W per metre and cuttable every 50mm.

Code	Description	Box Qty	Price/Length
LGB12141	14.4W 1MTR RGB NEW	1	£48.74
LGB12142	14.4W 2MTR RGB NEW	1	£67.91
LGB12143	14.4W 3MTR RGB	1	£87.91
LGB12144	14.4W 4MTR RGB NEW	1	£111.24
LGB12145	14.4W 5MTR RGB	1	£137.91

Drivers have six ports, use LEDCON (page 74) to add additional ports
(1 x LEDCON = 9 ports,
2 x LEDCON = 12 ports)

NEW Smart Drivers



FROM
£104.16
each

“Alexa, dim the lights”

Vision Smart LED Drivers can be used to control Vision LED lights using a compatible smart speaker or smart hub. This allows the user to turn the light on and off, adjust brightness and change the colour of the light using their voice or smartphone.

Code	Description	Box Qty	Price
LAZ030	LED Smart Driver Compatible with Alexa/Zigbee - 30W	1	£104.16
LAZ050	LED Smart Driver Compatible with Alexa/Zigbee - 50W	1	£122.91

Drivers

Selecting the right driver is easy – use the below formula to find the best option for your installation:

Total Power (W) = Length of LED x Power Rating of LED (W)

For example:

5 metres of Vision 9.6W LED tape uses a total of 48W. This installation will need to use a driver with a rating of at least 50W. The perfect option would be our 50W LED driver LDD50.

12V Drivers (LED) - Single White



Code	Description	Box Qty	Price
LDD30	LED DRIVER 30W	1	£39.58
LDD50	LED DRIVER 50W	1	£61.24
LDD100	LED DRIVER 100W	1	£153.69
LDD180	LED DRIVER 180W	1	£192.15
LDD1103 (110V)	LED DRIVER 30W	1	£127.50
LDD1105 (110V)	LED DRIVER 50W	1	£147.12

CCT / RGB - Multiple White & Red, Green, Blue



Code	Description	Box Qty	Price
LUNDR30	CCT RGB DRIVER 30W	1	£49.58
LUNDR50	CCT RGB DRIVER 50W	1	£76.66
LUNDR100	CCT RGB DRIVER 100W	1	£153.33
LUNDR180	CCT RGB DRIVER 180W	1	£192.08

Remote Control Options

Need more control? Vision RGB is compatible with single and multi-zone remote control, all you need is a receiver and remote control handset.

Driver and remote sold separately.

Single Zone Options - 4 Ports (CCT / RGB Driver Compatible)



Code	Description	Box Qty	Price
LEDRAD	Single White - LED Remote Dimmer and Controller	1	£61.24

Multi Zone Options (4 Zones / 3 Scenes)

1x driver and 1x receiver required per independent zone.



Code	Description	Box Qty	Price
LEDMZR	Single White - LED Receiver - Max 288W	1	£57.91
LEDREM	Single White - LED Remote - 30M Range	1	£92.08



Code	Description	Box Qty	Price
LCTRAD	Multiple White - CCT Remote Dimmer and Controller	1	£61.24



Code	Description	Box Qty	Price
LCTMZR	Multiple White - CCT Receiver - Max 720W	1	£107.49
LCTREM	Multiple White - CCT Remote - 30M Range	1	£92.08



Code	Description	Box Qty	Price
LGBRAD	RGB - Remote Dimmer and Controller	1	£61.24



Code	Description	Box Qty	Price
LGBMZR	Multi White & RGB - Receiver - Max 720W	1	£107.49
LGBREM	Multi White & RGB - Remote - 30M Range	1	£92.08

EyeLEDs



Only
£6.24
each

EyeLEDs are an individual, recess mounted LED unit which can be used to accentuate your installation. Compatible with our standard LED drivers and available in 3 colour temperatures – Cool, Natural and Warm White.

Code	Description	Box Qty	Price
LDP1204	12V, IP65 0.4W Recess Mounted with Micro connection, total Ø30mm, available 3000, 4000, 6000K. LDD30 Driver required	1	£6.24

NEW Dotless Flexible LED Tape



FROM
£61.24
each

- 10w per metre
- Natural White
- 1m, 2m and 3m coils
- Compatible with our standard drivers

A flexible strip of continuous lighting with 144 LED's per metre. Cutting intervals of 21mm with 2m power lead and micro connector.

Code	Description	Box Qty	Price
LSD14101.NW	IP66 Continuous LED Tape - 1m Coil	1	£61.24
LSD14102.NW	IP66 Continuous LED Tape - 2m Coil	1	£122.49
LSD14103.NW	IP66 Continuous LED Tape - 3m Coil	1	£183.74





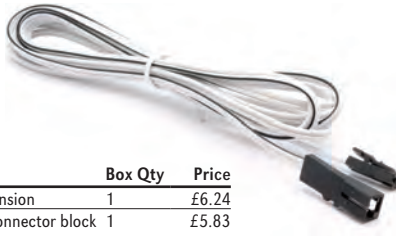









Accessories

FROM
£6.24
each



Code	Description	Box Qty	Price
LEDEXT	LED 2m Extension	1	£6.24
LEDCON	Additional connector block with 4 ports	1	£5.83

What you need

1. Lighting System	2. Driver	3. Receiver (optional)	
		Single Zone	or Multi Zone
 <p>NATURAL WHITE 4000K</p>	<p>LED</p> 	N/A	N/A
 <p>NATURAL WHITE 4000K</p>	<p>CCT RGB</p> 		<p>or</p> 
 <p>COOL WHITE 6000K NATURAL WHITE 4000K WARM WHITE 3000K</p>	<p>CCT RGB</p> 		<p>or</p> 
 <p>RED GREEN BLUE</p>	<p>CCT RGB</p> 		<p>or</p> 

Zones

- Zone 0 is IP67 and above
- Zone 1 is IP64 plus
- Zone 2 is IP64 plus

The tape should be at least 60cm from water source due to the wires / leads.

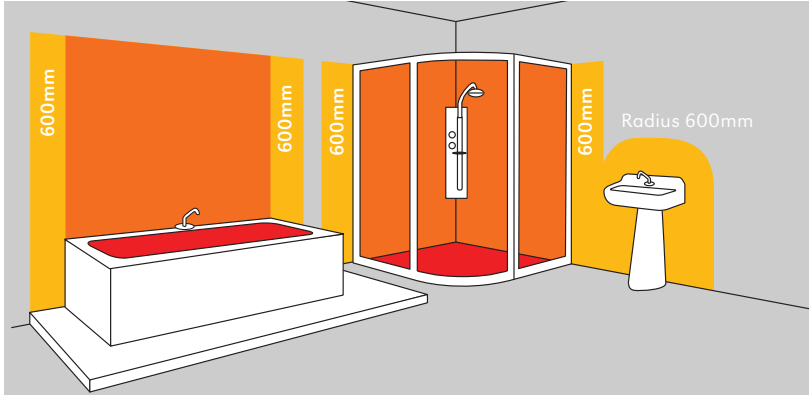

0
ZONE

1
ZONE

2
ZONE

OUTSIDE ZONES

RezTred®



Genesis are proud to introduce our anti-slip services to the corporate and retail world.

Our patented anti-slip resin finishes can be applied onto virtually any surface including natural stones, terrazzo, ceramics, porcelains, glazed tiles, metal treads, wood and glass.

All products can be retro-fitted as well as factory installed.

Theoretical coverage per tube:

- 3 x 10mm = 12m
- 2 x 25mm = 8m
- 25mm Discs = 24m (360 discs)



FROM
£5.41
each

Code	Description	Box Qty	Price
NRES.01	Tube of Resin - 400ml	1	£249.99
NRES.16	Tube of Resin - 400ml	1	£249.99
NRES.43	Tube of Resin - 400ml	1	£249.99
NRES252 - STEN	25mm Strip Stencil - 1.2m	1	£12.49
NRES103 - STEN	10mm Strip Stencil - 1.2m	1	£12.49
NRES25D - STEN	25mm Disc Stencil - 1.2m	1	£12.49
NRES - GUN	Applicator Gun	1	£47.49
NRES - SQUEEGEE	Applicator Squeegee	1	£3.74
NRES - CLEAN	Cleaner	1	£34.58
NRES - NOZZ	Replacement Nozzle	1	£5.41



PATHWAY

GUIDANCE SYSTEM

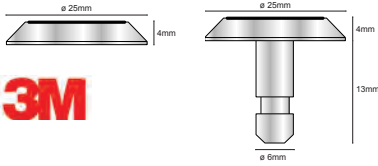

FROM
£4.99
each

The traditional 9mm Ø shank method or 3M adhered versions offer an incredibly versatile system that can provide an instant DDA and Equality Act 2010 compliant tactile surface to any platform edge, stairway or ramp due to their unique installation methods.

Manufactured from Stainless Steel grade 316 or Polyurethane, both of which are highly durable and offer excellent contrasting options to ensure conformity within internal and external applications.

Aluminium, Brass and other design options available, minimum order quantities may apply.

Based on 60mm centres - 361 tactiles per m²

Standard Pattern

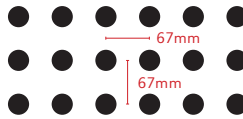

Platform Pattern

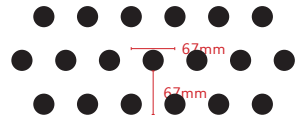

Stainless Steel Tactile

Crosshatch Anti-Slip Circle



Infill

01 White 16 Black 47 Yellow



PU Tactile

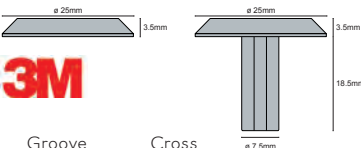

Groove Cross



Stainless Steel Shanked

Code	Ø (mm)	Description	Box Qty	Price
FTSSD25.01	25	Stainless Steel Anti-Slip Tactile	20	£4.99
FTSSD25.16	25	Stainless Steel Anti-Slip Tactile	20	£4.99
FTSSD25.47	25	Stainless Steel Anti-Slip Tactile	20	£4.99
FTSCD25.84	25	Stainless Steel Circle Tactile	20	£4.58
FTCHD25.84	25	Stainless Steel Crosshatch Tactile	20	£5.83

Stainless Steel Self Adhesive **3M**

Code	Ø (mm)	Description	Box Qty	Price
FTSA25.01	25	Stainless Steel Anti-Slip Tactile	20	
FTSA25.16	25	Stainless Steel Anti-Slip Tactile	20	£4.99
FTSA25.47	25	Stainless Steel Anti-Slip Tactile	20	£4.99
FTSA25.84	25	Stainless Steel Circle Tactile	20	£4.99
FTCA25.84	25	Stainless Steel Crosshatch Tactile	20	£4.99

Stainless Steel Corduroy Tactile Trim

Code	W x L (mm)	Description	Box Qty	Price
FTCD280.01	25 x 280	Stainless Steel Anti-Slip Shanked	20	£27.49
FTCD280.16	25 x 280	Stainless Steel Anti-Slip Shanked	20	£27.49
FTCD280.47	25 x 280	Stainless Steel Anti-Slip Shanked	20	£27.49
FTCA280.01	25 x 280	3M Stainless Steel Anti-Slip S/Adhesive	20	£37.91
FTCA280.16	25 x 280	3M Stainless Steel Anti-Slip S/Adhesive	20	£37.91
FTCA280.47	25 x 280	3M Stainless Steel Anti-Slip S/Adhesive	20	£37.91

PU Tactile Shanked

Code	W x L (mm)	Description	Box Qty	Price
FTPHD25.16	25 x 25	PU Cross Tactile	20	£0.83

PU Tactile Self Adhesive **3M**

Code	W x L (mm)	Description	Box Qty	Price
FTPYA25.16	25 x 25	PU Groove Tactile	20	£2.08
FTPCA25.16	25 x 25	PU Cross Tactile	20	£2.08

PU Corduroy Tactile Self Adhesive **3M**

Code	W x L (mm)	Description	Box Qty	Price
FTPA280.16	27 x 295	PU Corduroy Tactile	20	£11.90

TrakMat®

ENTRANCE MATTING

A versatile system incorporating aluminium sections with rubber or carpet inserts linked by semi-rigid P.V.C to cushion traffic and reduce noise.

The unique design allows the matting to be rolled easing transport, relocation and cleaning.

Light to medium traffic <2,000/day.

Use TrakMat® Fluted Rubber outside for primary coarse dirt retention.

Use TrakMat® Loop Pile inside to clean and absorb residual moisture and dirt.



FROM
£311.66
each

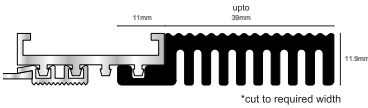

16
Black Anthracite Grey

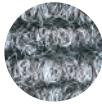

Red Natural

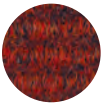

TrakMat® Fluted Rubber

Code	Height (mm)	Size	Price
EM8950.16	12	m ²	£311.66
EM8951.16	17	m ²	£363.74
EM8952.16	22	m ²	£394.99

TrakMat® Loop Pile

Code	Height (mm)	Finish	Size	Price
EM8900	12	Anthracite	m ²	£290.83
EM8901	12	Grey	m ²	£290.83
EM8902	12	Natural	m ²	£290.83
EM8903	12	Red	m ²	£290.83
EM8910	17	Anthracite	m ²	£342.91
EM8911	17	Grey	m ²	£342.91
EM8912	17	Natural	m ²	£342.91
EM8913	17	Red	m ²	£342.91
EM8920	22	Anthracite	m ²	£363.74
EM8921	22	Grey	m ²	£363.74
EM8922	22	Natural	m ²	£363.74
EM8923	22	Red	m ²	£363.74

End Profile

Code	Height (mm)	Length (m)	Price
EMCAP12.16	12	3	£34.14

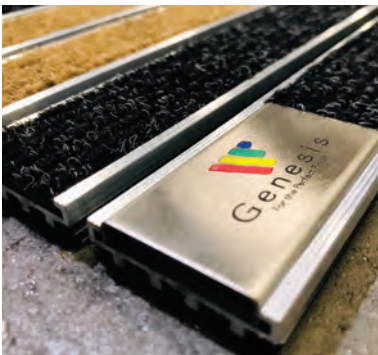

Reversible Rubber



16 Black

Heavy Traffic: >2000/day
 Use outside for primary coarse dirt retention.
 Aluminium sections containing rubber inserts linked with galvanised steel cables and secured with plated fixings. Designed for internal or external use.

Code	Height (mm)	Size	Price
R8030.16	18	m ²	£833.32
R8031.16	12	m ²	£913.32

Reversible Superior Insert



Grey

Heavy Traffic: >2000/day
 Use inside to clean and absorb residual moisture and dirt.
 Reversible inserts are fitted between mill profiles and assembled with galvanised steel rods.

Code	Height (mm)	Finish	Size	Price
R8000	18	Grey	m ²	£874.99
R8016	18	Black	m ²	£996.66
R8002	12	Grey	m ²	£833.32
R8003	12	Black	m ²	£958.32

Matwell Frame

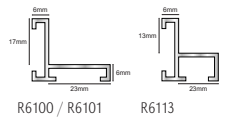

R6100 / R6101

R6113



Brass

Code	Length (m)	Description	Box Qty	Price/Length
R6100	4	For mats 17 or 23mm deep - Silver	1	£39.16
R6101	4	For mats 17 or 23mm deep - Brass	1	£149.99
R6113	4	For mats up to 13mm deep - Silver	1	£35.41

Aluminium Bevelled Access Profile

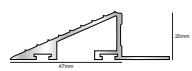

Silver

Code	Height (mm)	Length (m)	Box Qty	Price
R6115	20	3	1	£124.99

See also RAA154 Aluminium Access Ramp - Page 84

Corners



Silver

Code	Description	Box Qty	Price
R16104	Pack of 4 corner angles for frame	1	£6.66

Now available...

...Entrance Matting Samples Folder

Order yours today!

Self Adhesive - Cover

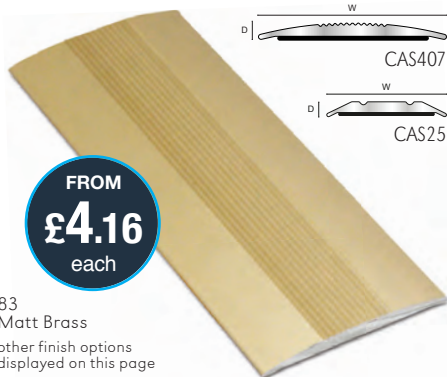

FROM
£4.16
each

83
Matt Brass
other finish options
displayed on this page

Code	W x D (mm)	L (m)	Box Qty	Price	Box Price
CAS407.40	37 x 3	2.7	10	£27.69	£18.33
CAS407.81	37 x 3	2.7	10	£17.92	£11.66
CAS407.83	37 x 3	2.7	10	£17.92	£11.66
CAS409.40	37 x 3	0.9	10	£10.18	£6.66
CAS409.81	37 x 3	0.9	10	£8.32	£4.16
CAS409.83	37 x 3	0.9	10	£8.32	£4.16
CAS257.81	25 x 3	2.7	10	£15.45	£9.99



Self Adhesive - Ramp



FROM
£4.16
each

83
Matt Brass
other finish options
displayed on this page

Code	W x D (mm)	L(m)	Box Qty	Price	Box Price
TAS157.40	50 x 15	2.7	10	£28.14	£17.91
TAS157.81	50 x 15	2.7	10	£19.32	£14.99
TAS157.83	50 x 15	2.7	10	£19.32	£14.99
TAS159.40	50 x 15	0.9	10	£10.34	£6.66
TAS159.81	50 x 15	0.9	10	£7.83	£4.99
TAS159.83	50 x 15	0.9	10	£7.83	£4.99
TAS107.40	43 x 10	2.7	10	£24.60	£16.24
TAS107.81	43 x 10	2.7	10	£18.17	£12.08
TAS107.83	43 x 10	2.7	10	£18.17	£13.74
TAS109.40	43 x 10	0.9	10	£9.02	£5.83
TAS109.81	43 x 10	0.9	10	£8.32	£4.16
TAS109.83	43 x 10	0.9	10	£8.32	£4.58

Self Adhesive - Vinyl/LVT Ramp



FROM
£3.74
each

81
Matt Silver
other finish options
displayed on this page

Code	W x D (mm)	Length (m)	Box Qty	Price/Length
TAV257.81	30 x 2.5	2.7	10	£9.99
TAV257.83	30 x 2.5	2.7	10	£9.99
TAV259.81	30 x 2.5	0.9	10	£3.74
TAV259.83	30 x 2.5	0.9	10	£3.74

Fast Fit Slimline



85
Pewter

FROM
£4.58
each

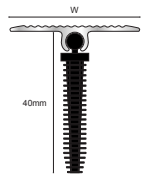
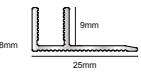
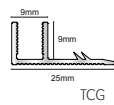
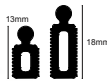

TCG

TCC

81
Matt Silver

83
Matt Brass

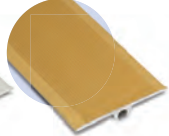
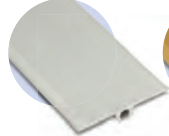

Perfect finishing for junctions of different floor coverings of same height.

- Covers a gap up to 30mm
- TCS for drill fitting option
- TCG Multiflex for Carpet installation
- TCC Multiflex for all other floor coverings

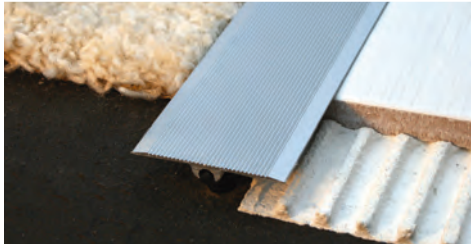

Code	W	L(m)	Box Qty	Price	Box Price
TCS409.81	40	0.92	20	£7.91	£4.99
TCS409.83	40	0.92	20	£7.91	£4.99
TCS409.85	40	0.92	20	£7.91	£4.99
TCS405.81	40	1.85	20	£15.78	£10.41
TCS405.83	40	1.85	20	£15.78	£10.41
TCS405.85	40	1.85	20	£15.78	£10.41
TCG109.80	9	0.92	20	£7.21	£4.58
TCC109.80	9	0.92	20	£7.21	£4.58

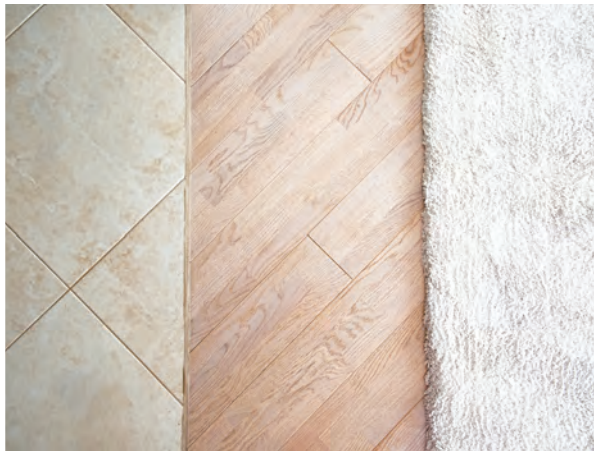

Fast Fit Ramp System



87
Brass Effect

FROM
£4.58
each

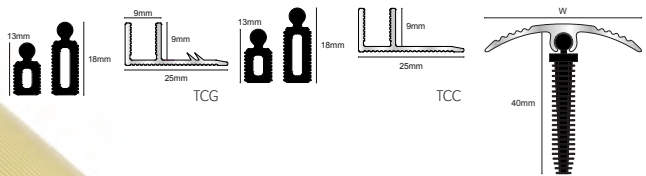

Unique Clip System. Allows use with different floor covering material depths. Accommodates height variation up to 20mm.

- TCR for drill fitting option
- TCG Multiflex base for carpet installation
- TCC Multiflex base for all other floor coverings
- TTG Multiflex set with gripper base
- TTC Multiflex set with universal base
- All Bases include 5 + 5 clips

40
Oak



81
Matt Silver

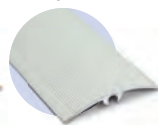

83
Matt Brass

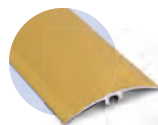

85
Pewter

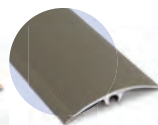

91
Bright Silver



Code	W	L (m)	Box Qty	Price	Box Price
TCR409.40	40	0.92	20	9.31	£5.83
TCR409.81	40	0.92	20	8.32	£4.99
TCR409.83	40	0.92	20	8.32	£4.99
TCR409.85	40	0.92	20	7.91	£4.99
TCR409.87	40	0.92	20	9.31	£5.83
TCR409.91	40	0.92	20	9.99	£5.83
TCR405.40	40	1.85	20	18.54	£12.08
TCR405.81	40	1.85	20	15.78	£10.41
TCR405.83	40	1.85	20	15.78	£10.41
TCR405.85	40	1.85	20	15.78	£10.41
TCG109.80	9	0.92	20	7.21	£4.58
TCC109.80	9	0.92	20	7.21	£4.58
TTG409.87 ¹	40	0.92	20	13.43	£8.74
TTG409.91 ¹	40	0.92	20	13.43	£8.74
TTC409.87 ²	40	0.92	20	13.43	£8.74
TTC409.91 ²	40	0.92	20	13.43	£8.74

¹TTG409 (TCR & TCG Combined) ²TTC409 (TCR & TCC Combined)

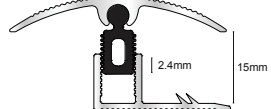
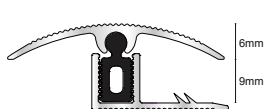
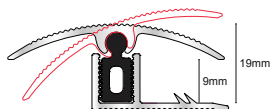
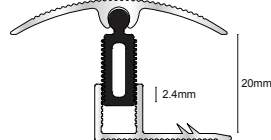
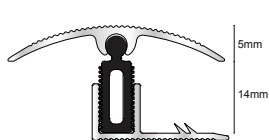
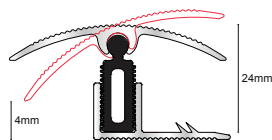
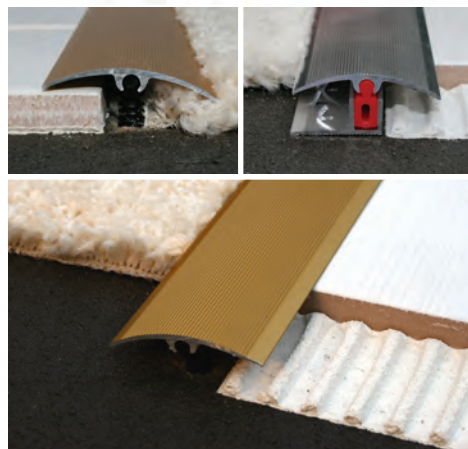

Aluminium Z-Bar Carpet Lock / Z-Bar Pro

The Aluminium Z-Bar Carpet Lock from Genesis provides an effective transition between different heights and types of floor finishes.

Simple to install the TGA profile provides a neat finish and protects the edges of both floor coverings even when they are slightly different depths.

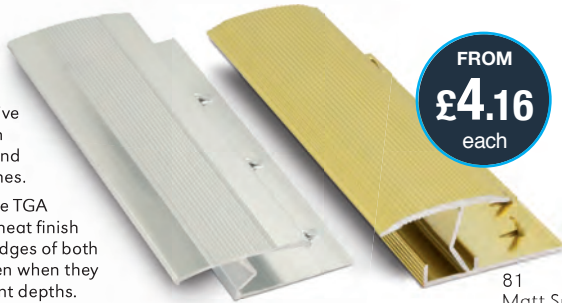

FROM
£4.16
each

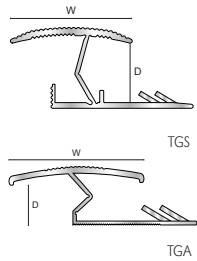

81 Matt Silver

83 Matt Brass

Code	W x D (mm)	L (m)	Box Qty	Price	Box Price
TGA909.81	30 x 9	0.9	45	£8.32	£4.16
TGA909.83	30 x 9	0.9	45	£8.32	£4.16
TGA909.87	30 x 9	0.9	45	£8.32	£4.16
TGA909.91	30 x 9	0.9	45	£8.32	£4.16
TGA907.81	30 x 9	2.7	15	£16.60	£10.83
TGA907.91	30 x 9	2.7	15	£17.92	£11.66
TGA149.81	30 x 14	0.9	45	£7.09	£4.58
TGA149.83	30 x 14	0.9	45	£7.09	£4.58
TGS159.87	30 x 15	0.9	45	£11.70	£7.49
TGS159.91	30 x 15	0.9	45	£11.70	£7.49



87 Brass Effect

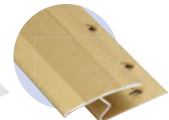

91 Bright Silver



Aluminium Retro-Fit Vinyl Reducer

Pre drilled

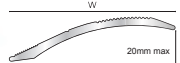

FROM
£4.58
each

81 Matt Silver

Code	W x D (mm)	Length (m)	Box Qty	Price/Length
TVA259.81	40 x 2.5	0.92	20	£4.58
TVA258.81	40 x 2.5	2.8	20	£10.41

Brushed Stainless Cover

Pre drilled

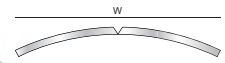
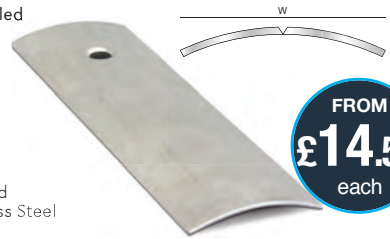

FROM
£14.58
each

102 Brushed Stainless Steel

Code	W x D (mm)	Length (m)	Box Qty	Price/Length
TSC307.102	30	2.7	40	£14.58
TSC407.102	40	2.7	40	£18.33

Vinyl Tread

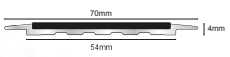

ONLY
£25.41
each

80 Mill Aluminium

Code	W x D (mm)	Length (m)	Box Qty	Price/Length
TSL547.80	70 x 4	2.7	10	£25.41

Price excludes insert, NISL/NITR50 see page 54

Aluminium Reducer



RAR157 - for easy access with pallet trucks, trolleys and wheelchairs.

RAR077 - for carpet tiles, loose lay PVC tiles etc.

Pre drilled
81 Matt Silver

FROM
£25.41
each

Code	H (mm)	Length (m)	Box Qty	Price/Length
RAR077.81	5 - 7	2.7	10	£25.41
RAR157.81	10.5 - 15	2.7	20	£52.52

Adjustable Ramp

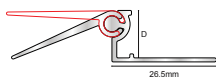

FROM
£16.66
each

81
Matt Silver

Code	D (mm)	Length (m)	Box Qty	Price/Length
RAD100.81	10	2.5	10	£16.66
RAD120.81	12	2.5	10	£17.08

Stainless Steel Tile-in Ramp



FROM
£25.83
each

84
Stainless Steel

Code	W x D (mm)	Length (m)	Box Qty	Price/Length
RSS104.84	20 x 10	2.5	10	£25.83
RSS124.84	25 x 12.5	2.5	10	£28.33

Tile Aluminium Ramp

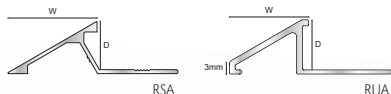

FROM
£7.08
each

81
Matt Silver
see other finish
options on page 100

Code	W x D (mm)	Length (m)	Box Qty	Price/Length
RSA104.80	20 x 10	2.5	20	£7.08
RSA104.81	20 x 10	2.5	20	£8.33
RSA124.80	23 x 12	2.5	20	£7.49
RSA124.81	23 x 12	2.5	20	£8.33
RUA104.81	16 x 10	2.5	20	£9.16
RUA124.81	19 x 12	2.5	20	£9.99

Aluminium Access Ramp



FROM
£29.16
each

81
Matt Silver

Code	W x D (mm)	Length (m)	Box Qty	Price/Length
RAA104.81	65 x 10	2.5	10	£29.16
RAA124.81	65 x 12.5	2.5	8	£29.58
RAA154.81	90 x 15	2.5	7	£37.49

Any RAL, Anywhere, Any time...



Our MHS, MHA & MMA profiles can now be ordered in a RAL of your choice, with matching angles and bespoke dimension all available with a quick turnaround.

...the possibilities are endless!



We make movement as easy as 1,2,3...

- 1 **Material Selection** – the material used to form the joint anchoring legs has no bearing on the movement capacity. Different materials provide added protection to the edge of the floor covering depending on the type and volume of traffic;

PVC - Light duty traffic, foot traffic only. Sight line is a consistent colour making it ideal for domestic applications in large rooms or doorways, removable leg for use as a perimeter in rooms greater than 4sqm, waterproof and suitable for swimming pool surrounds and wet areas.

Aluminium - Grade 6063 Aluminium provides extra protection to the floor covering and can be used in heavy traffic areas with foot and low point loading wheel traffic, ideal for use in car showrooms and shopping centres.

Stainless Steel - Available in Grade 304 and 316, this is the strongest of the materials giving the ultimate protection to the floor covering and ideal for all traffic. Popular with Airports and supermarkets where the wheel traffic has a high point loading and can cause the most impact damage. Grade 316 is recommended in swimming pool surrounds, food prep areas, hospitals and wet areas due to its increased corrosive resistance and strength.



MLB P.V.C.
Movement Joint



MSA Optimax
Aluminium HD



MSS Optimax
Stainless Steel HD



- 2 **Performance** – the movement accommodation is determined by the width of the joint infill. All Genesis joints conform to the BS5385 recommendations providing minimum 20% movement capacity on minimum capacity due to it's flexibility.
- 3 **Positioning** – the following points must be considered when choosing your movement joint:

Key points

- In all applications a movement joint must be used DIRECTLY above a joint in the sub-floor, whether this is the same type of subfloor or not. It is often missed domestically on extensions where a new subfloor will be constructed
- In the instance of commercial applications where there is a structural gap in the subfloor the movement joint must not overhang the gap, if the gap is 10mm and the infill of the movement joint is 6mm then select a different movement joint
- When tiling continues from room to room it is good practice to use a movement joint in the doorways, especially if the walls are load bearing

Considerations

- If there are no joints in the subfloor, start from the wall. If there are joints in the subfloor, start from the location of the joint. Positioning should then be 5-8m apart in any direction and ideally in square/rectangular bays. In domestic applications or corridors this can be extended to 10m
- A room 4sqm or larger with load bearing walls should have a perimeter joint in place
- Once a room/project exceeds 20sqm or extends into a second room you should be asking the question about a movement joint

P.V.C. Joint Covers

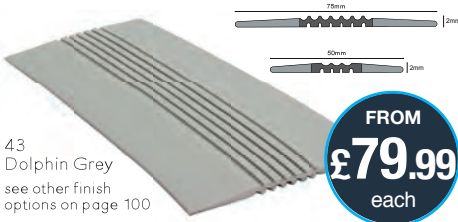

43
Dolphin Grey
see other finish options on page 100

Code	D (mm)	Length (m)	Box Qty	Price/Length
MVP250.16	50 x 2	15	10	£79.99
MVP250.43	50 x 2	15	10	£79.99
MVP275.16	75 x 2	15	10	£101.66
MVP275.43	75 x 2	15	10	£101.66

Optimax Aluminium Heavy Duty

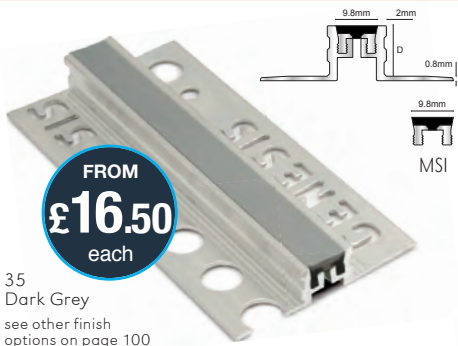

35
Dark Grey
see other finish options on page 100

Code	D (mm)	L (m)	Box Qty	Price	Box Price
MSA080.16	8	2.5	10	£19.99	£16.50
MSA080.25	8	2.5	10	£19.99	£16.50
MSA080.35	8	2.5	10	£19.99	£16.50
MSA100.16	10	2.5	10	£20.83	£17.60
MSA100.25	10	2.5	10	£20.83	£17.60
MSA100.35	10	2.5	10	£20.83	£17.60
MSA125.16	12	2.5	10	£22.49	£20.00
MSA125.25	12	2.5	10	£22.49	£20.00
MSA125.35	12	2.5	10	£22.49	£20.00
MSA150.16	15	2.5	10	£23.33	£21.00
MSA150.25	15	2.5	10	£23.33	£21.00
MSA150.35	15	2.5	10	£23.33	£21.00
MSA180.16	18	2.5	10	£23.74	£22.00
MSA180.25	18	2.5	10	£23.74	£22.00
MSA180.35	18	2.5	10	£23.74	£22.00
MSA225.16	22.5	2.5	10	£25.83	£23.00
MSA225.25	22.5	2.5	10	£25.83	£23.00
MSA225.35	22.5	2.5	10	£25.83	£23.00

Optimax Aluminium Heavy Duty Replaceable Infill

Code	D (mm)	L (m)	Box Qty	Price
MSI100.16	9.8	2.5	20	£12.91
MSI100.25	9.8	2.5	20	£12.91
MSI100.35	9.8	2.5	20	£12.91

Compression Joint with Barbs & Anchors

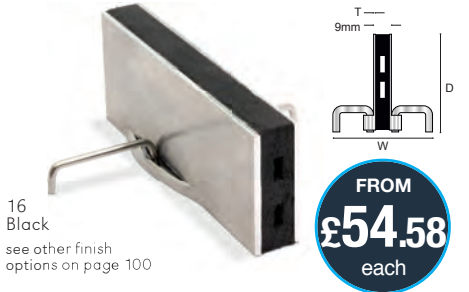

16
Black
see other finish options on page 100

Code	W x D (mm)	Length (m)	Material	Box Qty	Price/Length
MCA300.16	12 x 30	2.5m	Aluminium	10	£54.58
MCA300.35	12 x 30	2.5m	Aluminium	10	£54.58
MCB300.16	12 x 30	2.5m	Brass	10	£64.16
MCB300.35	12 x 30	2.5m	Brass	10	£64.16
MCS300.16	11 x 30	2.5m	Stainless Steel	10	£54.58
MCS300.35	11 x 30	2.5m	Stainless Steel	10	£54.58
MCA500.16	12 x 50	2.5m	Aluminium	10	£86.66
MCA500.35	12 x 50	2.5m	Aluminium	10	£86.66
MCB500.16	12 x 50	2.5m	Brass with barbs	10	£104.58
MCB500.35	12 x 50	2.5m	Brass with barbs	10	£104.58
MCS500.16	11 x 50	2.5m	Stainless Steel	10	£86.66
MCS500.35	11 x 50	2.5m	Stainless Steel	10	£86.66

Aluminium Intermediate Joint



16
Black
see other finish options on page 100

Code	D (mm)	Length (m)	Box Qty	Price/Length
MMA100.16	10	2.5	10	£24.58
MMA100.35	10	2.5	10	£24.58
MMA120.16	12	2.5	10	£24.99
MMA120.35	12	2.5	10	£24.99

P.V.C. Movement & Perimeter Joint

Notch to make leg removable

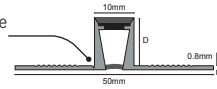

FROM
£4.99
each

35
Dark Grey
see other finish
options on page 100

Code	D (mm)	L (m)	Box Qty	Price	Box Price
MLB100.16	10	2.5	25	£7.85	£4.99
MLB100.25	10	2.5	25	£7.85	£4.99
MLB100.35	10	2.5	25	£7.85	£4.99
MLB125.16	12.5	2.5	25	£9.15	£4.99
MLB125.25	12.5	2.5	25	£9.15	£4.99
MLB125.35	12.5	2.5	25	£9.15	£4.99

P.V.C. Movement & Perimeter Joint

Notch to make leg removable

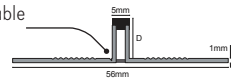

FROM
£3.99
each

25
Beige
see other finish
options on page 100

Code	D (mm)	L (m)	Box Qty	Price	Box Price
MLT100.16	10	2.5	25	£5.99	£3.99
MLT100.25	10	2.5	25	£5.99	£3.99
MLT100.35	10	2.5	25	£5.99	£3.99
MLT125.16	12.5	2.5	25	£5.99	£3.99
MLT125.25	12.5	2.5	25	£5.99	£3.99
MLT125.35	12.5	2.5	25	£5.99	£3.99

Optimax Stainless Steel Heavy Duty

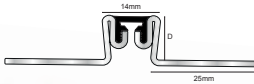

FROM
£49.99
each

16
Black
see other finish
options on page 100

Code	D (mm)	Length (m)	Box Qty	Price/Length
MSS100.16	10	2.5	10	£49.99
MSS100.35	10	2.5	10	£49.99
MSS120.16	12	2.5	10	£52.49
MSS120.35	12	2.5	10	£52.49

Stainless Steel Heavy Duty

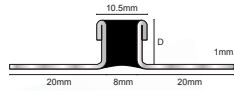

FROM
£54.99
each

25
Beige
see other finish
options on page 100

Code	D (mm)	Length (m)	Box Qty	Price/Length
MHS100.16	10	2.5	10	£54.99
MHS100.25	10	2.5	10	£54.99
MHS100.35	10	2.5	10	£54.99
MHS120.16	12	2.5	10	£61.66
MHS120.25	12	2.5	10	£61.66
MHS120.35	12	2.5	10	£61.66
MHS150.16	15	2.5	10	£75.83
MHS150.25	15	2.5	10	£75.83
MHS150.35	15	2.5	10	£75.83
MHS225.16	22.5	2.5	10	£134.99
MHS225.25	22.5	2.5	10	£134.99
MHS225.35	22.5	2.5	10	£134.99

Self Adhesive Structural Covers



81
Matt Silver

FROM
£55.41
each

102
Brushed Stainless Steel

FROM
£31.66
each

Stainless Steel Covers

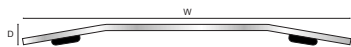

Code	W x D (mm)	Length (m)	Max Load	Box Qty	Price
GC2796.102	60 x 5	2.5	25kg/cm ²	10	£55.41
GC2797.102	80 x 5	2.5	15kg/cm ²	10	£68.74
GC2798.102	100 x 5	2.5	11kg/cm ²	10	£76.24

Side Drill available on request

Aluminium Covers



Code	W x D (mm)	Length (m)	Max Load	Box Qty	Price
GC2806.81	60 x 4	3	8kg/cm ²	10	£31.66
GC2820.81	80 x 4	3	55kg/cm ²	10	£39.16
GC2814.81	100 x 3	3	75kg/cm ²	10	£52.08

Side Drill available on request

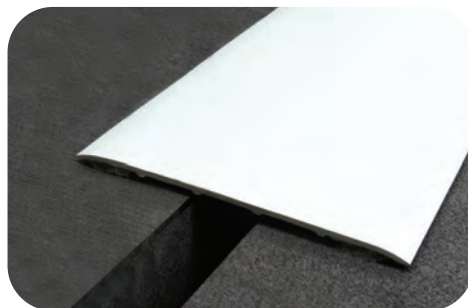
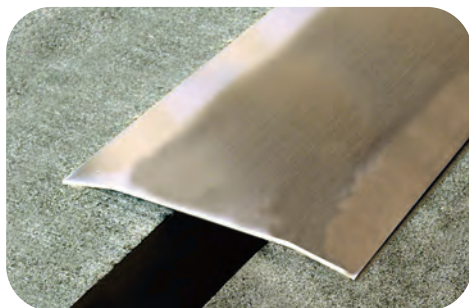

NEW Professional Grout Collection



See Grout section
pages 86 -89 for more details

PROFESSIONAL
Nicobond

Wet Rooms

for the Trade



N&C Premier Shower Deck



ONLY

£299

900 x 900mm



N&C Premier Infinity Shower Deck

N&C Premier Infinity shower deck is a revolutionary shower deck with a unique, factory fitted, sliding waste outlet that can be moved along by the installer to align the waste into position. Features a discreet waste with an invisible infinity edge. The single gradient means no envelope cutting is required for a seamless, fuss free finish.



ONLY

£490

each

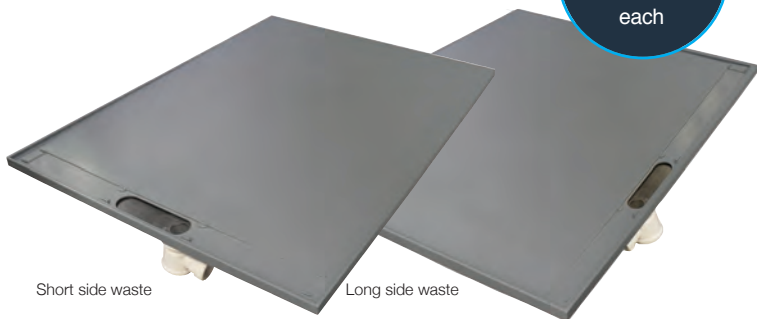

Short side waste

Long side waste



With threaded waste outlet 38mm

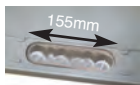

Slideable waste, up to 155mm, to avoid joists



Invisible drainage system

- Thickness: 28mm
- Density: 22kg/m²
- Self supporting
- 470kg load capacity
- 50% recycled plastic
- Can be tiled direct

Code	mm	Price
P6822006	1200 x 1200 square deck waste	£499
P6822007	1200 X 900 long side waste	£490
P6822008	1200 X 900 short side waste	£490

N&C Premier Infinity Tileable Insert Grating

Tileable insert grating for use with Premier Infinity shower deck



FROM
£17.37
each

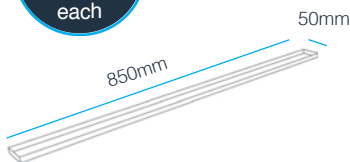

Code	mm	Price
S2220500	900 x 50 x 10	£17.37
S2220501	1200 x 50 x 10	£21.08
S2220502	900 x 50 x 12	£18.46

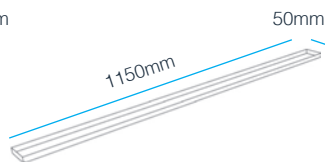

Code	mm	Price
S2220503	1200 x 50 x 12	£21.84
S2220504	900 x 50 x 14	£19.14
S2220505	1200 x 50 x 14	£22.74

N&C Premier Infinity Inclined Shower Profile

Inclined Profile for use with Premier Infinity shower deck



FROM
£17.46
each

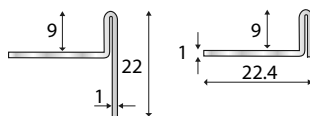

Code	mm	Price
S2220520	9 - 900 RH	£17.46
S2220521	9 - 1200 RH	£22.83
S2220522	9 - 900 LH	£17.46
S2220523	9 - 1200 LH	£22.83

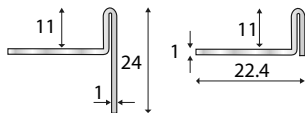

Code	mm	Price
S2220524	11 - 900 RH	£18.14
S2220525	11 - 1200 RH	£23.51
S2220526	11 - 900 LH	£18.14
S2220527	11 - 1200 LH	£23.51

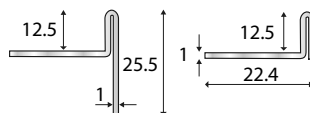

Code	mm	Price
S2220528	12.5 - 900 RH	£18.80
S2220529	12.5 - 1200 RH	£24.17
S2220530	12.5 - 900LH	£18.80
S2220531	12.5 - 1200 LH	£24.17

N&C Premier Infinity Tileable Grating

Tileable grating for use with Premier Infinity shower deck



FROM
£21.81
each

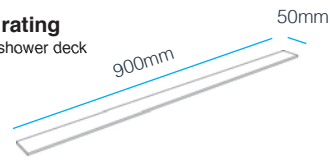

Code	mm	Price
S2220506	900 x 50 x 4	£21.81

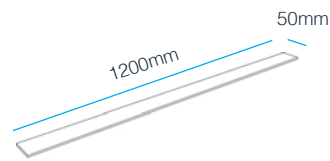

Code	mm	Price
S2220507	1200 x 50 x 4	£28.72

N&C Premier Infinity Trap System

Trap system for use with Premier Infinity shower deck. Supplied complete with 95° & straight 38mm multi-fit pipe connectors.



ONLY
£18.86
each

Code	mm	Price
S2370509	38	£18.86



N&C Premier Shower Deck

The Premier Shower Deck can easily be installed onto concrete by removing the screed, or onto timber floors, by removing the floorboards and fixing directly onto the joists. Can be trimmed onsite.

- Thickness: 22mm
- Density: 22kg/m²
- Self supporting
- 470kg load capacity
- 50% recycled plastic
- Can be tiled direct

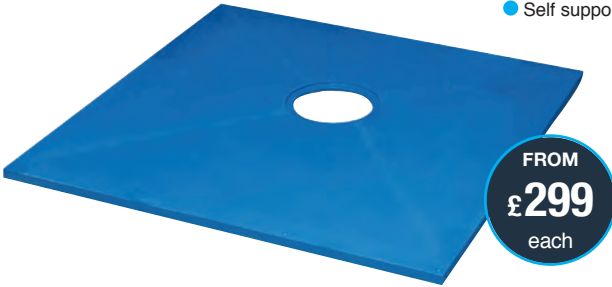

Code	mm	Price
P6821934	900 x 900	£299.00
P6821930	1000 x 1000	£299.00
P6821931	1135 x 770	£299.00
P6821936	1200 x 1200	£299.00
P6821932	1300 x 800	£299.00
P6821935	1400 x 900	£299.00
P6821933	1500 x 800	£299.00
P6821940	1800 x 800	£399.00
P6821929	1450 x 1150	£349.00
P6821941	1200 x 800	£299.00
P6821942	1650 x 900	£399.00
P6821943	1200 x 900	£299.00

N&C Phleximax 50 Shower Gully with vertical outlet

A superb drainage system for installation in concrete or timber floors and our Premier Shower Deck. 48ltrs per minute capacity



ONLY
£50.75
each

Code	mm	Price
P6882398	200 x 189	£50.75

N&C Phleximax 50 Shower Gully with horizontal outlet



ONLY
£45.80
each

Code	mm	Price
P6882441	200 x 76	£45.80

N&C Phleximax 50 Two Part Shower Gully with horizontal outlet



ONLY
£57.62
each

Code	mm	Price
P6882471	197 x 89	£57.62

N&C Phleximax Grating

Stainless steel grating for use with the N&C Phleximax Shower Gullies and tiled floors. All 155 x 155mm

ONLY
£52.07
each



Classic

Wave



Art Deco

Drop

Code	style	Price
P6882457	Classic	£52.07
P6882459	Wave	£52.07
P6882456	Art Deco	£52.07
P6882458	Drop	£52.07

N&C Phleximax Grating

Stainless steel grating for use with the N&C Phleximax Shower Gullies and tiled floors. All 128 x 128mm



Tile Insert

Twist Insert



Platinum Insert

FROM
£54.53
each

Code	style	Price
P6882472	Tile Insert	£57.97
P6882473	Twist Insert	£54.53
P6882474	Platinum Insert	£103.46

N&C Phleximax Tile Shower Drain Assembly

Our new Phleximax tiled drain adapter can be used in conjunction with our best in class Premier Shower Deck for tiled wet floor areas.

Height adjustable for different thickness tiles. All 120x120mm.

ONLY
£103.99
each



Satin Stainless Steel

Polished Stainless Steel

Oil Rubbed Bronze

Code	style	Price
P6882550	Satinless S/Steel	£103.99
P6882551	Polishes S/Steel	£103.99
P6882552	Bronze	£103.99

N&C Premier Shower Deck Linear Drain

The Premier Shower Deck can easily be installed onto concrete by removing the screed, or onto timber floors by removing the floorboards and fixing directly onto the joists. Can be trimmed onsite.

- Thickness: 22mm
- Density: 22kg/m²
- Self supporting
- 470kg load capacity
- 50% recycled plastic
- Can be tiled direct



600mm Gully		
Code	mm	Price
P6821988	900 x 1200	£399.00
P6821987	1200 x 1200	£399.00
P6821989	900 x 1500	£399.00

800mm Gully		
Code	mm	Price
P6821985	900 x 1400	£399.00
P6821986	900 x 1600	£399.00

N&C Premier Shower Deck Linear Drain



Twist



Tile



FROM
£249
each

Grate, waste and trap 50mm side outlet complete with concrete and joist installation kits and ABS 1 1/2 inch adaptor. Flow rate 60 litres per minute

Code	mm	Price
P6882501	Twist 600	£299.00
P6882502	Tile 600	£249.00
P6882511	Twist 800	£329.00
P6882512	Tile 800	£299.00



FROM
£249
each

Grate, waste and trap 50mm side low mini outlet complete with concrete and joist installation kits and ABS 1 1/2 inch adaptor. Flow rate 30 litres per minute

Code	mm	Price
P6882504	Twist 600	£299.00
P6882505	Tile 600	£249.00
P6882514	Twist 800	£329.00
P6882515	Tile 800	£299.00



FROM
£249
each

Grate, waste and trap 50mm side/ side outlet complete with concrete and joist installation kits and ABS 1 1/2 inch adaptor. Flow rate 60 litres per minute

Code	mm	Price
P6882507	Twist 600	£299.00
P6882508	Tile 600	£249.00
P6882517	Twist 800	£329.00
P6882518	Tile 800	£299.00

N&C Bottom Outlet Tile Grate & Joist Install Kit

Tile



FROM
£549
each



Code	mm	Price
P6882395	600	£599.00
P6882392	800	£549.00



Nicobond Wet Room Tanking Sheet

A tough sheet material designed to prevent water penetration on timber floors, forms part of the Nicobond Wet Room Tanking System.



ONLY
£54.99
each

Code	m	Price
N5200110	10 x 0.75	£54.99

Nicobond Wet Room Self Adhesive Tanking Sheet

A highly flexible & robust self adhesive butyl rubber /polypropylene tanking sheet for effective waterproofing of walls and floors.



FROM
£149.99
each

Code	m	Price
N5200180	10 x 1	£274.99
N5200175	5 x 1	£149.99

Nicobond Wet Room Waterproof Tape

A strong 80mm wide self adhesive reinforcing tape for floor and wall joints, forms part of the Nicobond Wet Room Tanking System



ONLY
£39.16
each

Code	m	Price
N5200125	20	£39.16

Nicobond Wet Room Waterproof Corners

Pre-formed waterproof corners fabricated from neoprene waterproofing tape



ONLY
£5.82
each

Code	mm	Price
Internal N5200130	120 x 120	£5.82
External N5200140	120 x 120	£5.82

Nicobond Wet Room Waterproof Large Pipe Collar

Specially designed for sealing around large penetrating pipe work and drainage outlets. Forms part of the Nicobond Wet Room Tanking System



ONLY
£16.66
each

Code	mm	Price	Trade
N5200150	500 x 500	£26.74	£16.66

Nicobond Wet Room Waterproof Small Pipe Collar

Specially designed for sealing around penetrating copper pipework and waste pipes. Forms part of the Nicobond Wet Room Tanking System



ONLY
£5.82
each

Code	mm	Price
N5200160	120 x 120	£5.82

Nicobond Wet Room Waterproofing Membrane

A quick drying, aqueous emulsion polymer based liquid applied waterproofing membrane for rigid surfaces in wet rooms, bathrooms and showers



ONLY
£58.32
each

Code	kg	Price
N5200100	8	£58.32

Nicobond Wet Room Waterproofing Tanking Kit

A convenient kit providing all necessary materials to waterproof a domestic shower area c/w 6kg of Waterproofing Membrane, 1200x750mm Tanking Sheet, 6m Waterproofing Tape & 1 Internal Corner Piece

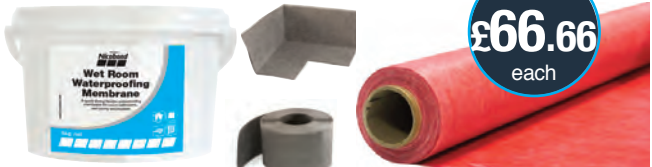

ONLY
£66.66
each

Code	mm	Price
N5200000	n/a	£66.66

Nicobond Wet Room Self Adhesive Tanking Kit

The Nicobond Self Adhesive Tanking Kit provides an excellent solution for quick and easy tanking in a wet room or shower environment. If tanking a wet room with a surface area in excess of 10m² then individual components may be purchased separately to complete the project. Contains self-adhesive wetroom sheet, 4 x internal corners, 1 x external corner, 1 x tape and 1 ltr Nicobond Primer



FROM
£216.66
each

Code	m ²	Price
N5200200	10	£333.33
N5200185	5	£216.66

Nicobond Tile Backer Board & Construction Panel

A polystyrene hard foam core and coated with a glass-fibre mesh reinforced cement based mortar layer on both sides



FROM
£10.26
each

Code	m	Price
N2553006	1.2 x 0.6 x 6mm	£10.26
N2553010	1.2 x 0.6 x 10mm	£10.26
N2553013	1.2 x 0.6 x 12mm	£11.19
N2553021	1.2 x 0.6 x 20mm	£13.06
N2553030	2.4 x 0.6 x 30mm	£32.66
N2553040	2.4 x 0.6 x 40mm	£37.32
N2553050	2.4 x 0.6 x 50mm	£42.92
N2553060	2.4 x 0.6 x 60mm	£47.59
N2553070	2.4 x 0.6 x 70mm	£63.46
N2553084*	2.4 x 1.2 x 12.5mm	£46.66

Nicobond Pre-Cut Construction Panel

Pre-slit construction panels for creating rounded shapes. 20mm thick.

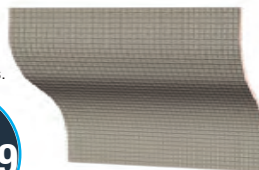

ONLY
£33.59
each

Code	m	Price
vertical slit		
N2553100	1.2 x 0.6 x 20mm	£33.59
Code	m	Price
horizontal slit		
N2553102	1.2 x 0.6 x 20mm	£33.59

Nicobond Smooth Pipe Covers

The easy to fit pipe cover ready for immediate tiling or painting. All sizes 2.4m long

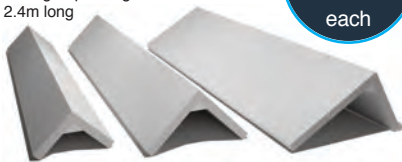

FROM
£49.99
each

Code	mm	Price
N2553150	140 x 140*	£49.99
N2553200	200 x 200	£60.83
N2553240	200 x 300	£70.83

Nicobond Waterproof Niche - Recessed Storage Unit

A pre-fabricated niche for fixing in-between the studs of timber frame walls. When used in conjunction with Nicobond Tile Backer Boards and Nicobond Waterproofing Self-adhesive Tapes, recessed storage spaces or "niches" can be created quickly and easily, resulting in a square, flat and professional look.



FROM
£49.99
each

Code	mm	Price
N2553400	250 x 340 x 120	£49.99
N2553402	350 x 340 x 120	£54.99
N2553404	450 x 340 x 120	£59.99

N&C Wet Zone Base

The perfect solution to accommodate a shower drain when unable to breach the floor

FROM
£145.99
each



Code	mm	Price
N2561000	1000 x 1000 x 105	£145.99
N2561500	1500 x 800 x 105	£179.99

Nicobond Hammer Set Galvanised Backer Board Fixings

Use with Nicobond Tile Backer Board when dot and dab fixing to solid wall substrates. Pack of 10

FROM
£5.83
pack 10



Code	mm	Price
N2553108	80 x 8	£5.83
N2553109	110 x 8	£8.33

Nicobond Galvanised Screws & Washers

Pack of 50 specially designed 35mm dia washer with corrosion resistant screws, used for fixing Nicobond Backer Board into timber studs



FROM
£8.33
each

Code	mm	Price
N2553112	45	£9.99
N2553114	25	£8.33

Nicobond Galvanised Washers 35mm

Pack of 50 specially designed 35mm dia washers for use with Nicobond Backer Board



ONLY
£7.49
each

Code	mm	Price
N2553116	35	£7.49

Nicobond Jointing Tape

48mm wide self adhesive jointing tape for backer board edges.



ONLY
£6.99
each

Code	m	Price
N2552120	45	£6.99

Flooring Screeds & Tools *for the Trade*



PALLET DEAL
£14.99
 per unit when buying full pallet (50 units)
 N5501040 and N5501004



ScreedPro Rapid Latex Fibre
 No Ammonia & Protein Free

Nicobond ScreedPro Latex

A versatile, two part self smoothing compound with excellent flow and flexibility. choose one of these two liquids dependent on application

- Internal Use
- Floors
- Rapid Setting
- Self Smoothing
- Excellent Flow
- Protein Free
- Feather Edge
- High Flexible
- Low Shrinkage
- Low Odour
- Available in 20kg / 4ltr
- Traffic 1 + 2 hours
- Lifetime Guarantee



ONLY
£9.99
 each

BS EN 13813 Classification
CT C25 F7

Code	kg	Price
N1540040	20	£9.99

Nicobond ScreedPro Latex Liquid

For use with Nicobond Speedpro Latex Powder

ONLY
£9.99
 each



Code	ltr	Price
N1540024	4	£9.99

Nicobond ScreedPro LatexFlex Liquid

For use with Nicobond Speedpro Latex Powder when applying to plywood or other timber surfaces and non porous concrete

ONLY
£12.48
 each



Code	ltr	Price
N1540000	4	£12.48

Nicobond ScreedPro Rapid Latex Fibre - No Ammonia & Protein Free

An ultra-rapid setting, highly versatile, fibre reinforced and moisture tolerant, two part self smoothing compound with excellent flow and flexibility.

- Ultra rapid setting
- Fibre reinforced
- Highly flexible
- Excellent flow & workability
- Superb adhesion to most substrates
- Suitable for use over most old adhesive residues*
- Apply floorcoverings after 4 hours*
- Exceptional performance even at lower temperatures
- No Ammonia and Protein Free
- *Refer to Technical Data Sheet for full details

ONLY
£11.65
each

BS EN 13813 Classification
CT C16 F5

Code	kg		Price
N5501040	20kg	Powder	£11.65
N5501004	4.8ltr	Liquid	£11.65



Nicobond ScreedPro Fibreflex

A premium, fibre reinforced flexible, self smoothing, self-levelling, fast setting compound which can be laid up to 50mm in one single application. Ideal for renovation work and over timber floors.

- 2 Hours Foot Traffic
- Protein Free
- Internal
- Flexible
- Under-Floor Heating
- Pumpable
- Working Time 20 - 30 mins
- Lifetime Guarantee

ONLY
£19.98
each

BS EN 13813 Classification
CT C35 F7

Code	kg	Price
N1540090	20	£19.98



Nicobond ScreedPro Rapid 30

A superior, rapid drying and rapid setting single part self levelling smoothing compound which can be tiled after 45 minutes and accept sheet vinyl after 4 hours.

- 30 Min Foot Traffic
- Protein Free
- Internal
- Flexible
- Under-Floor Heating
- Working Time 10 mins
- Lifetime Guarantee
- Water Lock Formulatio

ONLY
£24.99
each

BS EN 13813 Classification
CT C25 F6

Code	kg	Price
N1540070	20	£24.99



Nicobond ScreedPro All Purpose

A highly versatile rapid drying and rapid setting two part self smoothing underlayment which is ideal for use over old adhesive residues.

- 30 Min Foot Traffic
- Protein Free
- Internal
- Flexible
- Under-Floor Heating
- OPC Free
- Working Time 10 mins
- Lifetime Guarantee
- Water Lock Formulation

ONLY
£14.98
each

BS EN 13813 Classification
CT C16 F5

Code	kg	Price
N1540050	20kg	£14.98
N1540004	4.8ltr	£14.98



Nicobond ScreedPro Ecolevel 30

A superior, two part, high strength and highly flexible, rapid drying and rapid setting compound with exceptional flow which can be tiled after 45 mins and accept sheet vinyl after 4 hours.

- 30 Min Foot Traffic
- Protein Free
- Internal
- Flexible
- Under-Floor Heating
- OPC Free
- Working Time 10 mins
- Lifetime Guarantee
- Water Lock Formulatio

BS EN 13813 Classification
CT C25 F7

Code		Price	
N1540060	20kg	Powder	£15.79
N1540014	4.8ltr	Liquid	£15.79

ONLY
£15.79
each



Nicobond ScreedPro Level Floor

A premium, self smoothing, pre-aggregated, fast setting compound which can be laid up to 50mm in one single application providing an even base suitable for ceramic /porcelain and natural stone tile installations.

- 2 Hours Foot Traffic
- Protein Free
- Internal
- Under-Floor Heating
- Working Time 20 - 30 mins
- Pumpable
- Lifetime Guarantee
- The tilers screed

ONLY
£13.32
each



Code	kg	Price
N1540080	20	£13.32

Nicobond ScreedPro Flow

A premium, self smoothing, self levelling, fast setting compound with exceptional flow can be laid up to 50mm in one single application to create a smooth, flat surface.

- 2 Hours Foot Traffic
- Protein Free
- Internal
- Under-Floor Heating
- Working Time 20 - 30 mins
- Pumpable
- Lifetime Guarantee

ONLY
£19.99
each



BS EN 13813 Classification
CT C35 F6

Code	kg	Price
N1540030	20	£19.99

Nicobond ScreedPro Heavy Duty

A durable, high build and economic to use, pre-aggregated, self-smoothing and self-levelling, fast setting compound. Can be laid up to 50mm in a single application.

- 2 Hours Foot Traffic
- Protein Free
- Internal
- Under-Floor Heating
- Working Time 25 mins
- Pumpable
- Lifetime Guarantee

ONLY
£20.82
each



BS EN 13813 Classification
CT C40 F7

Code	kg	Price
N1540020	20	£20.82

Nicobond ScreedPro Cement Mix

A premium rapid setting, rapid drying and low shrinkage cement for use in floor screeds.

- 2 Hours Foot Traffic
- Protein Free
- Internal
- Exterior
- Under-Floor Heating
- Working Time 45 mins
- Lifetime Guarantee

ONLY
£34.99
each



BS EN 13813 Classification
CT C50 F10

Code	kg	Price
N1540100	20	£34.99

Nicobond ScreedPro Feather Finish

A premium multi-purpose flexible, fast setting, quick drying smoothing and patching compound.

- 15 Mins Foot Traffic
- Floors
- Internal
- Flexible
- Under-Floor Heating
- Working Time 10 - 15 mins
- Lifetime Guarantee

ONLY
£25.81
each



Code	kg	Price
N1540011	10	£25.81

Nicobond ScreedPro Rapid Repair Mortar

A cement based rapid repair mortar that is fast setting and hardening and ideal for external or internal use

- 30 Mins Foot Traffic
- External
- Internal
- Working Time 10 mins
- Lifetime Guarantee

ONLY
£15.82
each



Code	kg	Price
N1540010	10	£15.82

Nicobond One Coat Membrane

A one coat, two part, epoxy resin surface DPM and screed bonding agent and primer.

- Internal
- External
- Flexible
- Under-Floor Heating
- Lifetime Guarantee

FROM
£88.32
each



Code	kg	Price
N1580070	5	£88.32
N1580080	10	£148.32

Nicobond Moisture Vapour Suppressant

A one component moisture barrier for suppressing residual construction moisture in concrete slabs and cement screeds

ONLY
£91.65
each



Code	kg	Price
N1580090	6	£91.65

Nicobond Granite Chippings

Quality aggregate to add to our cement based smoothing and levelling compounds to provide increased strength and durability.

- Internal
- External
- Lifetime Guarantee

ONLY
£14.15
each



Code	kg	Price
N1620058	20	£14.15

Nicobond Super Cleaning Crystals

A special detergent for cleaning old floors prior to laying new underlayments or tiles.

- Internal
- External
- Lifetime Guarantee

ONLY
£39.99
each



Code	kg	Price
N1600075	8	39.99

Nicobond Multi Purpose Flooring Adhesive

A superior, high solids, water based flooring adhesive offering fast wet grab and a strong final bond. Suitable for fixing a wide variety of carpets and bonding Nicobond D-Mat 3L decoupling mat.

- Internal
- Under-Floor Heating
- Flexible
- Working Time 20 - 40 mins
- Lifetime Guarantee



FROM
£13
each

Code	kg	Price
F0000165	5	£13
F0000163	15	£32

Nicobond Pressure Sensitive Flooring Adhesive

A solvent free acrylic polymer emulsion adhesive that is non staining and designed to give an initial strong grab and a high bond strength.

- Internal
- Under-Floor Heating
- Flexible
- Working Time 20 mins
- Lifetime Guarantee



FROM
£18.25
each

Code	kg	Price
F0000168	5	£18.25
F0000167	15	£52

Nicobond Surface Tackifier Flooring Adhesive

A solvent free modified acrylic emulsion adhesive designed to provide a permanently tacky film for the positive holding of floor coverings with felt, bitumen and polymer backings.

- Internal
- Under-Floor Heating
- Flexible
- Lifetime Guarantee



FROM
£18
each

Code	kg	Price
F0000180	5	£18
F0000178	25	£73

Nicobond Acrylic Flooring Adhesive

A premium, superior performance, solvent free acrylic emulsion based flooring adhesive for bonding a wide range of hard/resilient floor coverings.

- Internal
- Under-Floor Heating
- Flexible
- Working Time 60 mins
- Lifetime Guarantee



FROM
£16
each

Code	kg	Price
F0000166	5	£16
F0000164	15	£38

Nicobond Contact Flooring Adhesive

A multi-purpose contact adhesive with excellent heat resistance that forms strong permanent contact bonds.

- Internal
- Under-Floor Heating
- Flexible
- Working Time 20 mins
- Lifetime Guarantee



ONLY
£26
each

Code	kg	Price
F0000182	5	£26

Nicobond Primer

An acrylic dispersion used for priming sand/cement screeds, concrete or render prior to applying Nicobond flooring or tiling products.



FROM
£10.58
each

Code	kg	Price
N1460003	5	£33.10
N1460006	1	£10.58



ScreedPro Rapid Latex Fibre No Ammonia

- Ultra rapid setting
- Fibre reinforced
- Highly flexible
- Excellent flow & workability
- Superb adhesion to most substrates
- Suitable for use over most old adhesive residues*
- Apply floorcoverings after 4 hours*
- Exceptional performance even at lower temperatures
- No Ammonia and Protein Free

*Refer to Technical Data Sheet for full details





The Ultimate Rapid Drying Latex Screed...

- Rapid Setting
- Rapid Drying
- Walk on time 30 minutes
- Floor Covering from 45 minutes
- Excellent Flow
- Protein Free
- Fibre Reinforced
- High Flexibility
- Low Odour
- OPC Free
- Outperforms Competitors' Latex Screeds at Lower Temperature





"Dries faster than any other latex screed on the market..."

Nicobond Sprayable Contact Adhesive

A multi-purpose, high strength, low odour spray adhesive designed to create a permanent strong bond.

ONLY
£2.91
each



Code	ml	Price
F0000186	500	£2.91

Nicobond Heavy Duty Spray Adhesive

A versatile heavy duty aerosol spray adhesive for fast track applications, bonds a wide variety of materials.

ONLY
£1.66
each



Code	ml	Price
F0000184	500	£1.66

Nicobond In Screed Underfloor Heating Cable Fixing Strip

Metallic strip that is secured to the substrate before securing heating cable using specially designed punched holding system

ONLY
£60
each

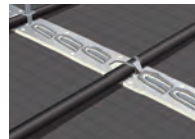

Code	mtr	Price
N2552620	25	£60

Nicobond Black Cable Ties

Pack of 100 high quality cable ties for securing in screed cable to reinforcing mesh



ONLY
£1.99
each

Code	mm	Price
H9939343	200x2.5	£1.99

Nicobond In Screed Underfloor Heating Cable (6mm)

The 6mm red heating cable that is perfect for new build or major renovation scenarios where a 65mm screed is going to be laid.



FROM
£27.70
each

Code	watts	Price
N2552600	120	£27.70
N2552601	220	£74.16
N2552602	330	£92.06
N2552603	440	£95.49
N2552604	550	£110.25
N2552605	640	£131.50
N2552606	750	£152.08
N2552607	950	£177.56
N2552608	1070	£192.77
N2552609	1380	£217.32
N2552610	1530	£248.45
N2552611	1800	£263.44
N2552612	2190	£307.75
N2552613	2770	£321.14
N2552614	3530	£393.89

Nicobond Moisture Meter Kit

For assessing the moisture content of a variety of construction materials. Includes a general purpose probe, heavy duty hammer probe and a pack of pins for each instrument.



ONLY
£195
each

Code	Price
F0000194	kit £195

Nicobond Digital Hygrometer

A calibrated digital hygrometer box for carrying out moisture tests on concrete floors and screeds prior to the installation of floor coverings.



ONLY
£70
each

Code	Price
F0000188	each £70

N&C Butyl Tape

Replacement tape for use with Digital Hygrometer and Hygro Box



ONLY
£10
each

Code	mtr	Price
F0000196	8	£10

Nicobond Hygro Box

An insulated humidity box for measuring relative humidity or temperature.



ONLY
£60
each

Code	Price
F0000190	each £60

N&C Grommet Caps

Replacement Grommet Caps for use with Hygro Boxes



ONLY
£10
each

Code	Price
F0000197	Pack £10

Nicobond Thermo Probe

An easy to use relative humidity and air temperature measuring instrument.



ONLY
£70
each

Code	Price
F0000192	each £70

Nicobond Deep Wall Probe

Optional extra probe for use with Thermo Probe, designed to measure moisture deep within walls and floors



ONLY
£45
each

Code	Price
F0000200	each £45

N&C Moisture Meter Spare Pins (Pack of 50)

Spare pins for use with moisture Nicobond General Purpose Probe within the Moisture Meter Kit



ONLY
£7.50
pack

Code	Price
F0000201	Pack £7.50

N&C Hammer Probe Spare Pins (Pack of 10)

Spare pins for use with the hammer probe in the moisture meter kit



ONLY
£35
pack

Code	Price
F0000202	Pack £35

Nicobond Skid Leveller*

Adjustable stainless steel blade with two end skids, ideal for rough and uneven floors.

ONLY
£85
each



Code	inch	Price
F6102052	24	£85

Nicobond Pin Leveller *

Made from heavy gauge aluminium and has a slotted steel blade for setting various depths.

ONLY
£71.50
each



Code	inch	Price
F6102051	24	£71.50

Nicobond Spikey Roller *

Roller to aerate screeds and level smoothing compounds and coatings to the required depth.

FROM
£25
each

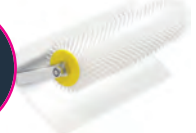

Code	mm	Price
F0000114	18 x 21	£35
F0000115	12 x 21	£25
F0000120	18 x 31	£38
F0000121	12 x 31	£28

Nicobond Extendable Handle

For use with spikey rollers, pin leveller, skid leveller.



ONLY
£11.10
each

Code	ft	Price
F0000140	2' - 4'	£11.10

Nicobond Screeding Trowel

A smoothing underlayment finishing trowel with a heavy square edge gauge steel blade.



ONLY
£6
each

Code	size	Price
F6102016	n/a	£6

Nicobond Smoothing Trowel *

A screed finishing trowel properly shaped and tempered.



ONLY
£45
each

Code	size	Price
F6102055	n/a	£45

Nicobond Bucket Trowel

Ideal for removing mortar/adhesive from a bucket of similar containers.



ONLY
£3.50
each

Code	mm	Price
N2540066	160	£3.50

Nicobond Notched Trowel Handle

Interchangeable handle for use with notched trowel blades.



ONLY
£9
each

Code	size	Price
F6102020	n/a	£9

Nicobond V Notched Trowel Blade

Used to spread and comb flooring adhesive. For use with Nicobond Notched Trowel Handle



ONLY
£3.50
each

Code	mm	Price
F0000031	2	£3.50
F0000032	1.5	£3.50
F0000033	1	£3.50

Nicobond Mixing Paddle

An all purpose mixing paddle, generates a thorough mix action.



ONLY
£4.25
each

Code	mm	Price
N2540145	400 x 80	£4.25

Nicobond Flexible Mixing Bucket

Multi-use flexible buckets ideal for pouring, mixing, carrying and storing.



FROM
£3.99
each

Code	ltr	Price
N2540160	40	£6.49
N2540158	26	£4.99
N2540156	12	£3.99

Nicobond Heavy Duty Bucket

Heavy duty construction with pouring lip. Used for measuring water.



ONLY
£2.75
each

Code	ltr	Price
N2540152	15	£2.75

Nicobond Heavy Duty Knee Pads

Tough wearing pads that protect knees from abrasion.

ONLY
£12.90
each



Code	Size	Price
N2540146	One size	£12.90

Nicobond Extension Wall Roller*

For rolling vinyl floorcoverings, carpet and wall coverings.

ONLY
£25
each



Code	Size	Price
F6102021	n/a	£25

Nicobond Hand Scraper

Suitable for removing vinyl floor tiles.

ONLY
£5.75
each



Code	Size	Price
N2540198	n/a	£5.75

Nicobond Grinding Stone

Stones with D-Shaped handle used to remove trowel marks or high spots from screed.

ONLY
£30
each



Code	mm	Price
F0000122	205 x 105	£30

Nicobond Long Handled Floor Scraper

Ideal for the removal of vinyl floor, floor tiles.

ONLY
£25
each



Code	Size	Price
F0000028	n/a	£25

Nicobond Long Handled Floor Scraper Blades

Spare blades for long handled scraper

ONLY
£10
each



Code	Size	Price
F0000029	n/a	£10

Nicobond Hand Scraper 12"

For stripping large areas of flooring. Extra long handle for better leverage

ONLY
£10
each



Code	inch	Price
F0000026	12	£10

Nicobond Hand Scraper Blades (Pack of 10)

Spare blades for hand scraper

FROM
£3.50
pack



Code	mm	Price
F0000019	14	£3.50
F0000020	18	£4.00

Nicobond Quarter Moon Knife Trim Plate *

Trim plate for quarter moon knife guides the knife along the rod and holds the knife edge off the surface.

ONLY
£3
each



Code	Size	Price
F0000022	n/a	£3

Nicobond Leather Sheath For Quarter Moon Knife *

Leather Sheath For Quarter Moon Knife

ONLY
£11
each



Code	Size	Price
F6102047	n/a	£11



* product discontinued

N&C Pro Tape Measure

Accurate, durable and ergonomic tape measure with metric and imperial scales, impact resistant case, spring return mechanism, 25mm wide tape and handy belt clip.



ONLY
£4.95
each

Code	mtr	Price
H9990185	5	£4.95

Nicobond Carpet Cutter Jute *

Suitable for cutting jute, hessian or action backed carpets.



ONLY
£7
each

Code	Size	Price
F0000080	n/a	£7

Nicobond Carpet Clamp *

Aluminium construction. Designed to help pull up carpet or sheet flooring. Gives extra leverage and the harder you pull, the tighter the grip



ONLY
£13.50
each

Code	Size	Price
F0000085	n/a	£13.50

Nicobond Large Stair Tool *

Bolster suitable for tucking carpets along skirting etc.



ONLY
£12
each

Code	mm	Price
F0000034	75	£12

Nicobond Gripper Shears *

Gripper shears for cutting carpet gripper to fit the contours of any room



ONLY
£13.50
each

Code	Size	Price
F0000065	n/a	£13.50

Nicobond Grooming Roller *

Ideal compliment tool when carpet seam joining.



ONLY
£9.50
each

Code	Size	Price
F0000084	n/a	£9.50

Nicobond Stick-It

High performance gap filling panel adhesive.

ONLY
£3.92
each



Code	ml	Price
N1740000	310	£3.92

Nicobond Skeleton Gun

Heavy duty sealant gun for 310ml and 400ml cartridges. Made in the UK from high quality steel. BS 9001



ONLY
£2.99
each

Code	ml	Price
N2540162	up to 400	£2.99

Nicobond Fire Protection Board

Fire Retardant grade protection board is fully approved to LPS 1207 and meets the LPCB standards..



ONLY
£4
each

Code	m	Price
N5100100	2.4x1.2	£4

Nicobond Protection Board

Manufactured from polypropylene giving an all round protection on site.

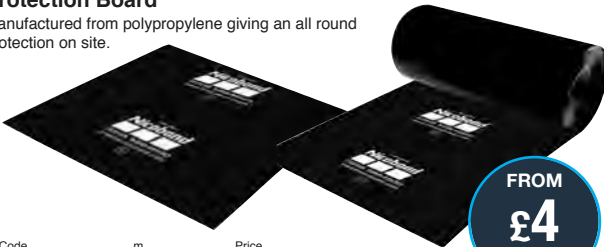

FROM
£4
each

Code	m	Price
N5100050	2.4x1.2	£4
N5100075	50x1	£55



Leister Welding Kit

Leicester "Triac ST" Weld Gun Acorn Nozzle, 50mm Speedweld Nozzle P-Type Groover, Pressure roller, Crescent Knife, Crescent Knife Guide



ONLY
£499
each

Code	volt	Price
F0000027	230	£499
F0000045	110	£499

Leister Triac ST Welding Gun

Robust hot air tool for welding and shrinking plastic, comes complete with nozzle.



ONLY
£479
each

Code	volt	Price
F6102011	230	£479
F0000024	110	£479

Nicobond Acorn Nozzle for Leister Welding Gun

This nozzle is used as an adapter on Triac welding guns. It is required to enable the fitting of welding nozzles to the gun



ONLY
£15
each

Code	Size	Price
F0000025	n/a	£15

Speed Nozzle

Speed weld nozzle suitable for use with Triac range



ONLY
£15
each

Code	mm	Price
F6102014	5	£15

Element for Vinyl Floor Welder

Spare element is for the Leister hot air welder



ONLY
£59
each

Code	volt	Price	Trade
F0000043	230	£82.04	£59
F0000042	110	£82.04	£59

Altro Grooving Tool

Altro Type Hand Grooving Tool for use with



FROM
£3.50
each

Code	Size	Price
F6102035	n/a	£12
F6102033	n/a	£3.50

For use with Altro Type Hand Grooving Tool

Nicobond Router Blades

Pack of 2 square blades for use with X-Acto Heavy Duty Handle



ONLY
£2.50
pack

Code	Size	Price
F6102040	n/a	£2.50

Nicobond Router Blades

Pack of 2 round blades for use with X-Acto Heavy Duty Handle



ONLY
£2.50
pack

Code	Size	Price
F6102038	n/a	£2.50

Nicobond Router Blades

Pack of 2 diamond blades for use with X-Acto Heavy Duty Handle



ONLY
£2.50
pack

Code	Size	Price
F6102039	n/a	£2.50

Nicobond Short Scriber

A scriber hand tool used for marking lines on your flooring, prior to cutting



ONLY
£15
each

Code	Size	Price
F0000051	n/a	£15

Replacement needles

F0000076	n/a	£10
F0000075	n/a	£3

Nicobond P Type Groover

The P Type groover is a tool the hard floor layer, used to cut a groove in hard or safety flooring prior to welding the flooring sheets together.

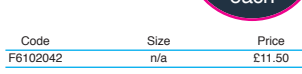

ONLY
£11.50
each

Code	Size	Price
F6102042	n/a	£11.50

Blades for use in Nicobond P Type Groover

F6102043	n/a	£8.50
----------	-----	-------

Nicobond Brass Pressure Roller

Tool for pressing weld rod when installing vinyl weld hard flooring.



ONLY
£10
each

Code	mm	Price
F0000049	80	£10

Vinyl Flooring

for the Trade



ikon

Wet Room Safety Vinyl

40m2 Full Roll

£15.99 m²

all colours



N&C Ikon Wet Room Safety Vinyl Sheet

High performance, slip resistant, safety flooring for wet and dry areas for both barefoot and shod users. This floor covering has a raised emboss design for applications where there are continuous wet areas, achieving a slip resistance PTV of 36+. Being a resilient product this floor covering can be used in both domestic and commercial environments, is 100% recyclable and comes with a 12 year warranty. N&C Ikon Wetroom Safety Vinyl Sheet can be purchased in cut sizes (roll width of 2m x desired length) or by full rolls of 20 x 2m



Linen WV757
WR 2654
LRV 63.0

Latte WV749
WR 2174
LRV 41.2

Wedgwood Blue WV754
WR 0923
LRV 31.8

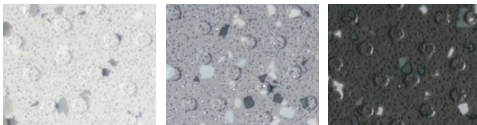

Grey WV707
WR 2415
LRV 60.6

Cloud Grey WV761
WR 0033
LRV 23.6

Antracite WV 780
WR 2238
LRV 9.7

Code	Colour	Price per m2
F2344707	WV707 Grey	£18.99
F2344749	WV749 Latte	£18.99
F2344754	WV754 Wedgwood Blue	£18.99
F2344757	WV757 Linen	£18.99
F2344761	WV761 Cloud Grey	£18.99
F2344780	WV780 Antracite	£18.99



ONLY

£18.99 m²

N&C Ikon

Wet Room Safety Vinyl Weld Rod

Weld rod to suit N&C Ikon Wetroom Safety Vinyl Sheet. 100 lin meter roll

ONLY

£39.38 each

Code	Colour	Price per roll
F2344904	WR707 Grey	£39.38
F2344902	WR749 Latte	£39.38
F2344903	WR754 Wedgwood Blue	£39.38
F2344901	WR757 Linen	£39.38
F2344905	WR760 Cloud Grey	£39.38
F2344906	WR780 Antracite	£39.38

N&C Aqua Floor Shower Deck

The N&C Aqua-Floor shower deck is a high strength wet room shower deck that has been compression moulded using a high glass content SMC formulation. Accepts 350kg of loading with 22mm level access base, perfect for vinyl floored wet rooms

Market leading strength and rigidity
 Accepts 55 Stone / 350kg of loading
 Unique high grade SMC formulation
 Computer aided cellular structure design
 Suitable for timber / joist installation
 Beds well into concrete / screed substrates
 Unique cross linked rib design for optimum strength
 No under boarding required
 22mm level access base
 Pre formed fixing holes
 Drill guideline - if additional fixing points are required
 Precision engineered gradients / slopes
 Pre-cut waste outlet suitable for gravity waste
 or pumped waste systems
 Waste offset to avoid joists
 Can be trimmed on site

FROM
£199
 each



Nicobond

Code	mm	Price
P6820430	1500x1500	£249
P6820432	1000x1000	£199
P6820431	900x900	£199
P6820437	1800x800	£199
P6820436	1500x800	£199
P6820435	1400x900	£199
P6820434	1300x800	£199
P6820433	1135x770	£199

N&C Phleximax 50 Shower Gully with vertical outlet

A superb drainage system for installation in concrete or timber floors and our Premier Shower Deck. 48ltrs per minute capacity

ONLY
£50.75
 each



Code	mm	Price
P6882398	200 x 189	£50.75

N&C Phleximax 50 Shower Gully with horizontal outlet

ONLY
£45.80
 each



Code	mm	Price
P6882441	200 x 76	£45.80

N&C Phleximax 50 Two Part Shower Gully with horizontal outlet

ONLY
£57.62
 each



Code	mm	Price
P6882471	197 x 89	£57.62

Phleximax WAVE Grating for Vinyl Floors

150mm diameter stainless steel grates in three designs for use with vinyl floors

ONLY
£50.05
 each



Code	mm	Price
P6882453	Wave	£50.05

Phleximax DROP Grating for Vinyl Floors

150mm diameter stainless steel grates in three designs for use with vinyl floors

ONLY
£50.05
 each



Code	mm	Price
P6882452	Drop	£50.05

Phleximax ART DECO Grating for Vinyl Floors

150mm diameter stainless steel grates in three designs for use with vinyl floors

ONLY
£50.05
 each



Code	mm	Price
P6882451	Art Deco	£50.05

Altro Aquarius Safety Vinyl Flooring

Speciaprince solution for combined wet and dry, shoe and barefoot areas. Keeps you safe while using common contaminants such as shampoo and conditioner. Achieves a PTV value of 36+



Code	Colour	Price per m2
F5020500	Swan	£27.50
F5020508	Tern	£27.50
F5020514	Puffin	£27.50
F5020518	Dragonfly	£27.50
F5020520	Blue Penguin	£27.50
F5020524	Hippo	£27.50



Swan

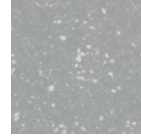

Tern

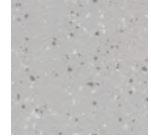

Puffin



Dragonfly



Blue Penguin

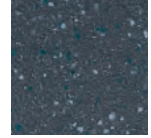

Hippo

Altro Aquarius Vinyl Weld Rod

Weld rod for Altro Aquarius Safety Vinyl Flooring

ONLY
£19.75
each

Code	Colour	Price per m2
F5020452	Swan	£19.75
F5020444	Tern	£19.75
F5020438	Puffin	£19.75
F5020431	Dragonfly	£19.75
F5020432	Blue Penguin	£19.75
F5020456	Hippo	£19.75

Altro Mastic

Coloured Mastic for finishing edges of Altro Aquarius Safety Vinyl Flooring



ONLY
£24.75
each

Code	Colour	Price per m2
F5020490	Swan	£24.75
F5020480	Tern	£24.75
F5020474	Puffin	£24.75
F5020468	Dragonfly	£24.75
F5020186	Blue Penguin	£24.75
F5020494	Hippo	£24.75



UK's leading total wet room solutions provider

Nicobond Vinyl Tile PU

N&C Ikon Vinyl Tiles are a multipurpose, durable, semi flexible vinyl floor tile. The tile has an excellent wear rating and its PU coating makes it the perfect choice for schools, residential, offices, shops etc.

Nicobond Vinyl Tiles come in boxes of 4.5m² per box



ONLY
£30.99
per 4.5m²
box

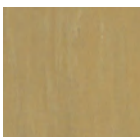

NVT1 Marble
Beige 2 LRV 34

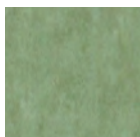

NVT2 Marble
Green LRV 32



NVT3 Marble
Blue LRV 32



NVT4 Marble
Light Grey LRV 48



NVT5 Marble
Dark Grey 2 LRV 29

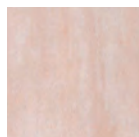

NVT7 Marble
Light Beige LRV 49

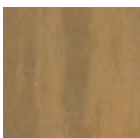

NVT8 Marble
Dark Beige LRV 26



NVT10 Marble
Charcoal LRV 11

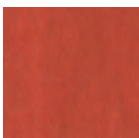

NVT22 Minimal
Red LRV 17



NVT23 Minimal
Brown LRV 12



NVT24 Minimal
Chocolate LRV 8



NVT25 Minimal
Mid Grey LRV 27

Code	Colour	Price per 4.5m ² box
F2340281	NVT1 Marble Beige 2	£30.99
F2340282	NVT2 Marble Green	£30.99
F2340284	NVT3 Marble Blue	£30.99
F2340286	NVT4 Marble Light Grey	£30.99
F2340289	NVT5 Marble Dark Grey 2	£30.99
F2340292	NVT7 Marble Light Beige	£30.99
F2340294*	NVT8 Marble Dark Beige	£30.99
F2340298	NVT10 Marble Charcoal	£30.99
F2340312	NVT21 Minimal White	£30.99
F2340314	NVT22 Minimal Red	£30.99
F2340316	NVT23 Minimal Brown	£30.99
F2340318	NVT24 Minimal Chocolate	£30.99
F2340320	NVT25 Minimal Mid Grey	£30.99

* Product discontinued

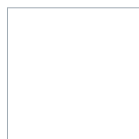

NVT21 Minimal
White LRV 77

Undertile Heating

for the Trade



Digital Thermostat

only
£41.66
 each



Nicobond Professional Undertile Heating Mat 150W/m²

A mid powered, energy efficient undertile heating mat suitable for floor warming or solo heat source in well insulated areas.

Code	per m2	Watts	Price
N2551802	1	150	£46.94
N2551805	1.5	225	£60.34
N2551808	2	300	£68.36
N2551811	2.5	375	£88.08
N2551814	3	450	£95.56
N2551817	4	600	£123.08
N2551820	5	750	£148.20
N2551823	6	900	£181.34
N2551826	7	1050	£210.50
N2551829	8	1200	£240.56
N2551832	9	1350	£251.02
N2551835	10	1500	£265.62



FROM
£46.94
 each

Nicobond Professional Undertile Heating Mat 200W/m²

A high powered, energy efficient undertile heating mat for use as a solo heat source or for rooms with high heat loss.

Code	per m2	Watts	Price
N2550006	0.6 *	120	£44.78
N2550010	1	200	£54.00
N2550016	1.6	320	£76.52
N2550020	2	400	£85.78
N2550026	2.6	520	£101.60
N2550028	2.8	560	£107.70
N2550035	3.5	700	£125.34
N2550042	4.2	840	£160.26
N2550054	5.4 *	1080	£195.18
N2550060	6 *	1200	£212.06
N2550067	6.7 *	1340	£228.62
N2550075	7.5 *	1500	£259.26
N2550089	8.9 *	1780	£295.60
N2550099	9.9	1980	£337.24

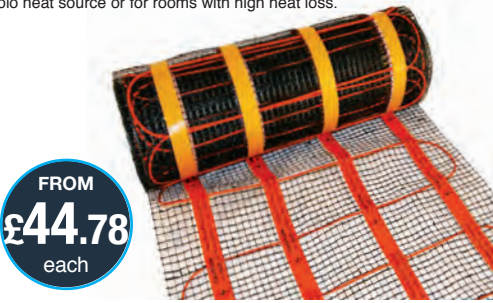

FROM
£44.78
 each

Nicobond Undertile Heating Cable

Loose undertile heating cable allowing easy installation regardless of the room size or shape.

FROM
£57.62
each

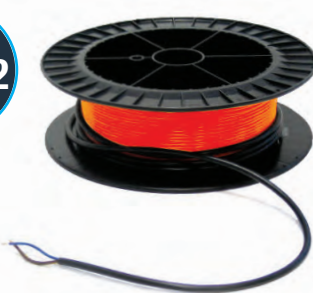

Code	per m2	Watts	Price
N2550200	1 - 1.3	200	£57.62
N2550300	1.5 - 2	300	£66.14
N2550400	2 - 2.7	400	£72.56
N2550600	3 - 4	600	£102.44
N2550800	4 - 5.3	800	£123.74
N2551000	5 - 6.7	1000	£155.78
N2551400	7 - 9.3	1400	£224.06
N2551600	8 - 10.7	1600	£249.68

Nicobond Digital Thermostat

An advanced 7 day programmable thermostat for undertile heating.

ONLY
£41.66
each



Code	Colour	Type	Price
N2552124	White	Digital	£41.66

Nicobond Digital Touch Screen Thermostat

Fully programmable thermostat with coloured touch screen display. Very easy and intuitive to use.

ONLY
£111.29
each



Code	Colour	Type	Price
N2552110	White	Touch Screen	£111.29

Nicobond Thermostat Conversion Kit

Conversion kit for Nicobond Touch Screen Thermostats



ONLY
£46.47
each

Black Glass
N2552109



White Glass
N2552108



Brushed Aluminium
N2552112



Chrome
N2552111

Code	Colour	Price
N2552108	White Glass	£46.47
N2552109	Black Glass	£46.47
N2552111	Chrome	£46.47
N2552112	Brushed Aluminium	£46.47

Nicobond Demista Mirror Demister

A simple solution to ensure mirrors remain permanently condensation free in a bathroom.

FROM
£21.96
each



Code	mm	Price
N2551700	274 x 265	£21.96
N2551702	400 x 450	£40.36
N2551704*	524 x 520	£43.98

* product discontinued

Undertile Heating

for the Trade



HEATMYHOME
BY HEATCOM

**Undertile Heating
Cable 160W/m**

Online
Only

FROM
£25
each



Heat My Home Undertile Heating Cable

The Heat My Home range of undertile heating cables are ideally suited to small areas or complex shaped rooms. The cable is manufactured to EN 60335-2-96 and has a 15 year warranty.



FROM
£31.77
each



Code	per m2	Watts	Price
N2538902	0.9-1.3	130	£31.77
N2538904	1.5-2.3	230	£37.28
N2538906	2-3	300	£42.08
N2538908	3-4.5	450	£57.67
N2538910	4.9-7.3	730	£73.28
N2538912	5.9-8.8	880	£82.17
N2538914	7.8-11.7	1170	£99.11
N2538916	9.8-14.7	1470	£117.74
N2538918	14.6-21.9	2190	£161.35



Online
Only

Heat My Home Undertile Heating Cable 160W/m²

The Heat My Home range of 160W/m² undertile heating mats are fast to install and suited to larger floor areas. The cable is manufactured to EN 603335-2-96 and has a 15 year warranty.



FROM
£25
each

Code	per m2	Watts	Price
N2538930	1	160	£25.00
N2538932	1.5	240	£29.90
N2538934	2	320	£39.90
N2538936	2.5	400	£44.90
N2538938	3	480	£54.90
N2538940	4	640	£64.90
N2538942	5	800	£89.90
N2538944	6	960	£109.90
N2538946	7	1120	£119.90
N2538948	8	1280	£132.90
N2538950	9	1440	£149.90
N2538952	10	1600	£159.90
N2538954	12	1920	£195.90

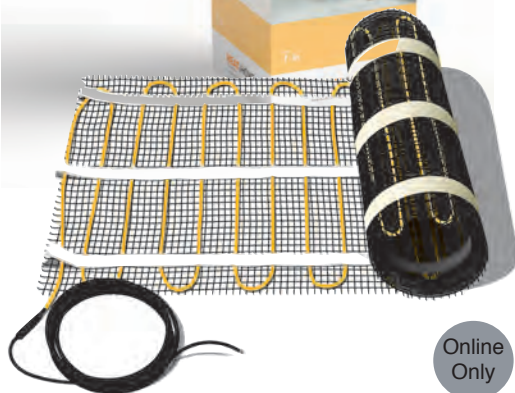

Online
Only

Heat My Home Undertile Heating Cable 200W/m²

The Heat My Home range of 200W/m² undertile heating mats are designed to be used as a primary heat source or for rooms with high heat loss. The cable is manufactured to EN 603335-2-96 and has a 15 year warranty.



FROM
£24.57
each

Code	per m2	Watts	Price
N2538970	0.9	180	£24.57
N2538972	1.7	340	£37.29
N2538974	2.5	500	£59.90
N2538976	3.4	680	£85.00
N2538978	4.2	840	£107.15
N2538980	5	1000	£127.70
N2538982	5.9	1180	£135.00
N2538984	6.7	1340	£143.72
N2538986	7.5	1500	£160.88
N2538988	8.4	1680	£180.18
N2538990	10	2000	£214.50



Online
Only

Undertile Heating

for the Trade

Heat Mat
Underfloor Heating

**NGTouch Wi-Fi
TouchScreen
Thermostat**

FROM
£118.39
each



240W mats suitable for sole-source heating in small or high heat-loss rooms

Product code	Coverage (m ²)	Length (m)	Wattage (W)	Price (RTP ex. VAT)
All Heat Mat underfloor heating mats are 0.5m wide				
PKM-240-0050	0.5	1.0	120W	£53.10
PKM-240-0080	0.8	1.6	200W	£66.69
PKM-240-0110	1.1	2.2	270W	£73.17
PKM-240-0130	1.3	2.6	320W	£86.77
PKM-240-0150	1.5	3.0	360W	£99.07
PKM-240-0170	1.7	3.4	410W	£110.72
PKM-240-0210	2.1	4.2	490W	£123.03
PKM-240-0270	2.7	5.4	650W	£150.87
PKM-240-0320	3.2	6.4	770W	£178.06
PKM-240-0390	3.9	7.8	910W	£214.97
PKM-240-0460	4.6	9.2	1100W	£248.64
PKM-240-0550	5.5	11.0	1290W	£295.91
PKM-240-0650	6.5	13.0	1520W	£339.29
PKM-240-0760	7.6	15.2	1820W	£396.92
PKM-240-0850	8.5	17.0	2020W	£443.54
PKM-240-0930	9.3	18.6	2210W	£484.33
PKM-240-1140	11.4	22.8	2710W	£591.82

- The highest output, fastest heating system we offer
- Energy-efficient
- Ultra-thin cable adds minimal build height
- Close cable spacing for superior heat spread
- Suitable under thick floor coverings including stone and brick
- Can be used for drying out floors around swimming pools or in wet rooms
- Lifetime warranty

240W mats provide sole source heating in very small areas such as small rooms, en-suites and garden rooms or high heat loss rooms including conservatories and foyers. They are also suitable for spaces where only part of the floor can be heated due to fitted units. 240W mats provide a high-output, fast reacting mat system adding minimal build height. 240W mats are quick to install and covered by a Lifetime warranty.



Underfloor Heating Mats



200W Mats – a powerful heating system for use beneath tile and stone

Product code	Coverage (m ²)	Length (m)	Wattage (W)	Price (RTP ex. VAT)
All Heat Mat underfloor heating mats are 0.5m wide				
PKM-200-0060	0.6	1.2	130W	£35.61
PKM-200-0100	1.0	2.0	208W	£55.69
PKM-200-0160	1.6	3.2	310W	£71.23
PKM-200-0200	2.0	4.0	405W	£88.06
PKM-200-0260	2.6	5.2	512W	£107.49
PKM-200-0280	2.8	5.6	576W	£118.49
PKM-200-0350	3.5	7.0	719W	£144.39
PKM-200-0420	4.2	8.4	854W	£169.65
PKM-200-0540	5.4	10.8	1083W	£207.85
PKM-200-0600	6.0	12.0	1196W	£229.86
PKM-200-0670	6.7	13.4	1353W	£252.53
PKM-200-0750	7.5	15.0	1504W	£286.84
PKM-200-0890	8.9	17.8	1769W	£331.52
PKM-200-0990	9.9	19.8	1973W	£358.07
PKM-200-1320	13.2	26.4	2620W	£477.86

- High output heating mats
- Ideal for high heat loss rooms
- Quick and easy to install
- 3mm cable for low build height
- Supplied with 4m coldtails
- Lifetime warranty valid even when used with alternative manufacturers thermostats



Our 200W high-output heating mats have a fast warm-up time. They are ideal for sole source heating in spaces where central heating is not

available, such as conservatories and high heat loss rooms. 200W mats must only be used under tile, stone or cementitious floors.



Underfloor Heating Mats



160W Underfloor heating mats – suitable for almost any floor covering

- Zero-float mesh for use with levelling compounds
- Suitable for almost any floor covering
- Quick and easy to install
- 3mm cable for low build height
- Supplied with 4m coldtails
- Lifetime warranty valid even when used with alternative manufacturers thermostats

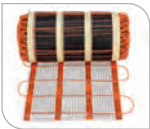

160W mats are fast reacting and high-quality making them suitable for the majority of applications. 160W mats can be installed beneath almost

any floor covering if covered with a levelling compound (compound not required when used beneath tiles). They can be used for sole source heating in well insulated spaces or to warm the floor if alternative heating is present.



Product code	Coverage (m ²)	Length (m)	Wattage (W)	Price (RTP ex. VAT)
All Heat Mat underfloor heating mats are 0.5m wide				
PKM-160-0070*	0.7	1.4	120W	£33.02
PKM-160-0100	1.0	2.0	160W	£46.62
PKM-160-0110	1.1	2.2	179W	£49.21
PKM-160-0130	1.3	2.6	208W	£58.28
PKM-160-0150	1.5	3.0	245W	£67.34
PKM-160-0180	1.8	3.6	288W	£77.05
PKM-160-0200	2.0	4.0	327W	£80.94
PKM-160-0230	2.3	4.6	380W	£95.83
PKM-160-0260	2.6	5.2	416W	£104.90
PKM-160-0280	2.8	5.6	457W	£110.08
PKM-160-0310	3.1	6.2	509W	£123.03
PKM-160-0370	3.7	7.4	601W	£141.80
PKM-160-0390	3.9	7.8	624W	£147.63
PKM-160-0440	4.4	8.8	720W	£163.82
PKM-160-0470	4.7	9.4	752W	£172.88
PKM-160-0520	5.2	10.4	854W	£189.07
PKM-160-0560	5.6	11.2	896W	£203.32
PKM-160-0620	6.2	12.4	1040W	£223.39
PKM-160-0680	6.8	13.6	1113W	£235.04
PKM-160-0770	7.7	15.4	1275W	£259.00
PKM-160-0830	8.3	16.6	1328W	£275.19
PKM-160-0870	8.7	17.4	1439W	£283.61
PKM-160-0980	9.8	19.6	1568W	£312.74
PKM-160-1040	10.4	20.8	1700W	£324.40
PKM-160-1160	11.6	23.2	1856W	£352.89
PKM-160-1280*	12.8	25.6	2000W	£388.50

*These mats are not currently BEAB approved, but are manufactured to the same standards.

Underfloor Heating Mats



110W Underfloor heating mats suitable for energy-efficient, well insulated homes

Product code	Coverage (m ²)	Length (m)	Wattage (W)	Price (RTP ex. VAT)
All Heat Mat underfloor heating mats are 0.5m wide				
PKM-110-0110	1.1	2.2	120W	£36.91
PKM-110-0140	1.4	2.8	150W	£47.27
PKM-110-0200	2.0	4.0	220W	£55.69
PKM-110-0300	3.0	6.0	320W	£81.59
PKM-110-0410	4.1	8.2	450W	£105.54
PKM-110-0490	4.9	9.8	540W	£123.03
PKM-110-0580	5.8	11.6	660W	£133.39
PKM-110-0700	7.0	14.0	770W	£157.34
PKM-110-0830	8.3	16.6	930W	£187.13
PKM-110-0900	9.0	18.0	1020W	£198.14
PKM-110-1020	10.2	20.4	1090W	£225.33
PKM-110-1150	11.5	23.0	1250W	£230.51

- Ideal for energy-efficient properties
- Quick and easy to install
- 3mm cable for low build height
- Pre-spaced heating cable
- Lifetime warranty



Our ultra-thin high-quality heating mats are ideal for new builds, or well insulated, energy-efficient properties, where a low

heat output is sufficient.

The 110W mat is very economical over larger areas due to the lower power consumption. This system is particularly suited to Passivhaus and sustainable properties.

They are also suitable for projects where a limited power supply is available.



Nicobond Tile Backer Board & Construction Panel

A polystyrene hard foam core and coated with a glass-fibre mesh reinforced cement based mortar layer on both sides

- 87kg/m2 weight loading
- Insulating properties
- Class O fire rated
- High U value
- Improves undertile heating

FROM
£10.26
each

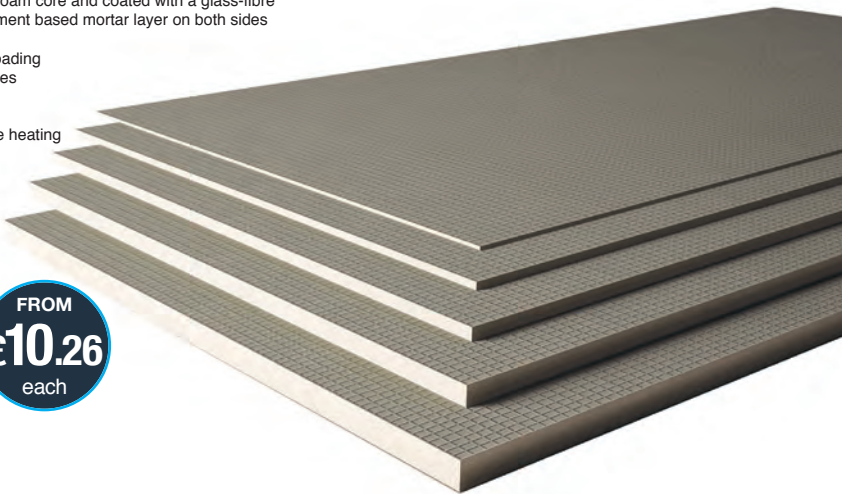

Code	m	Price
N2553006	1.2 x 0.6 x 6mm	£10.26
N2553010	1.2 x 0.6 x 10mm	£10.26
N2553013	1.2 x 0.6 x 12mm	£11.19
N2553021	1.2 x 0.6 x 20mm	£13.06
N2553030	2.4 x 0.6 x 30mm	£32.66

Code	m	Price
N2553040	2.4 x 0.6 x 40mm	£37.32
N2553050	2.4 x 0.6 x 50mm	£42.92
N2553060	2.4 x 0.6 x 60mm	£47.59
N2553070	2.4 x 0.6 x 70mm	£63.46
N2553084	2.4 x 1.2 x 12.5mm	£46.66

Nicobond Smooth Pipe Covers

The easy to fit pipe cover ready for immediate tiling or painting.
All sizes 2.4m long

FROM
£49.99
each

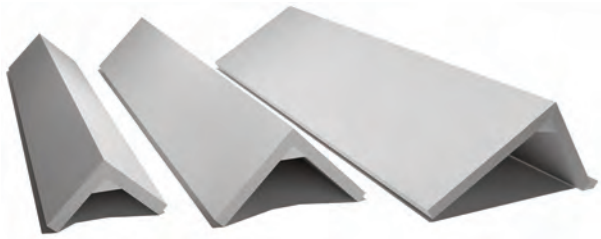

Code	mm	Price
N2553150	140 x 140*	£49.99
N2553200	200 x 200	£60.83
N2553240	200 x 300	£70.83

Nicobond Pre-Cut Construction Panel

Pre-slit construction panels for creating rounded shapes.
20mm thick.

ONLY
£33.59
each

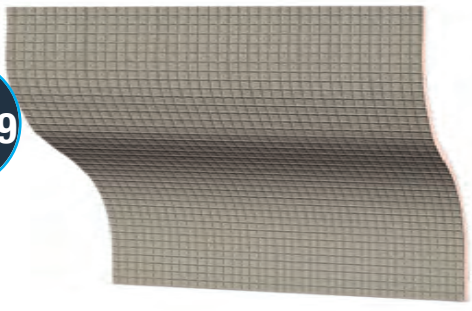

Code	m	Price
vertical slit		
N2553100	1.2 x 0.6 x 20mm	£33.59
Code	m	Price
horizontal slit		
N2553102	1.2 x 0.6 x 20mm	£35.59

Underfloor Heating Cables



Our most cost-effective system – can be used beneath a screed to heat a whole house or a single room

Product code	Unit power (W)	Length (m)	Coverage at 200W/m ² c-c 10cm	Coverage at 175W/m ² c-c 12.5cm	Coverage at 150W/m ² c-c 15cm	Coverage at 125W/m ² c-c 17.5cm	Price (RTP ex. VAT)
PKC-6.0-0120	120W	5.8	0.6 m ²	0.7 m ²	0.8 m ²	1.0 m ²	£32.00
PKC-6.0-0220	220W	10	1.1 m ²	1.3 m ²	1.5 m ²	1.8 m ²	£44.00
PKC-6.0-0330	330W	15	1.7 m ²	1.9 m ²	2.2 m ²	2.6 m ²	£66.00
PKC-6.0-0440	440W	20	2.2 m ²	2.5 m ²	3.0 m ²	3.5 m ²	£77.00
PKC-6.0-0550	550W	25	2.8 m ²	3.1 m ²	3.7 m ²	4.4 m ²	£94.00
PKC-6.0-0640	640W	30	3.2 m ²	3.6 m ²	4.4 m ²	5.1 m ²	£105.00
PKC-6.0-0750	750W	36	3.8 m ²	4.3 m ²	5.1 m ²	6.0 m ²	£115.00
PKC-6.0-0950	950W	44	4.8 m ²	5.4 m ²	6.5 m ²	7.6 m ²	£134.00
PKC-6.0-1070	1070W	50	5.4 m ²	6.1 m ²	7.3 m ²	8.6 m ²	£147.00
PKC-6.0-1380	1380W	64	6.9 m ²	7.8 m ²	9.4 m ²	11.0 m ²	£178.00
PKC-6.0-1530	1530W	71	7.7 m ²	8.7 m ²	10.4 m ²	12.2 m ²	£187.00
PKC-6.0-1800	1800W	84	9.0 m ²	10.2 m ²	12.2 m ²	14.4 m ²	£211.00
PKC-6.0-2190	2190W	101	11.0 m ²	12.4 m ²	14.9 m ²	17.5 m ²	£237.00
PKC-6.0-2770	2770W	130	13.9 m ²	15.7 m ²	18.8 m ²	22.2 m ²	£285.00
PKC-6.0-3530	3530W	163	17.7 m ²	20.1 m ²	24.0 m ²	28.2 m ²	£353.00

- **Quick and simple to install onto reinforcement fabric**
- **Our most affordable underfloor heating solution**
- **No increase in build height**
- **Extended warranty**

No allowance for build height is required because the system sits within a screed bed. If the system is fitted at 150W/sqm almost any floor covering can be used on top.

The 6mm cable is exceptionally fast to install, it can be tied onto reinforcement fabric, making it ideal for new developments, renovation projects or extensions.



Combymat System

150W



150W Combymat system – a versatile system suitable for floating laminate and engineered board floors

- No need for levelling compound
- Quick and easy to install
- Fit directly beneath floating laminate and engineered board floors
- Lifetime warranty

Our 150W Combymat system is designed to provide sole source heating beneath laminate and engineered board floors. Use directly beneath floating laminate and engineered board floors, or combine with the overlay boards for carpet and vinyl floors. (See opposite page).

All Combymats must be installed on top of the 6mm Combymat underlay and our aluminium tape must always be used during install, to help spread the heat evenly over the floor and to provide earth shielding. This range is not suitable for use in bathrooms and other wet rooms.

Product code	Coverage (m ²)	Length (m)	Wattage (W)	Price (RTP ex. VAT)
All Heat Mat underfloor heating mats are 0.5m wide				
CBM-150-0100	1.0	2.0	150W	£36.91
CBM-150-0150	1.5	3.0	225W	£53.10
CBM-150-0200	2.0	4.0	300W	£67.99
CBM-150-0250	2.5	5.0	375W	£86.77
CBM-150-0300	3.0	6.0	450W	£99.72
CBM-150-0350	3.5	7.0	525W	£114.61
CBM-150-0400	4.0	8.0	600W	£128.85
CBM-150-0450	4.5	9.0	675W	£144.39
CBM-150-0500	5.0	10.0	750W	£158.64
CBM-150-0600	6.0	12.0	900W	£186.48
CBM-150-0700	7.0	14.0	1050W	£209.14
CBM-150-0800	8.0	16.0	1200W	£238.93
CBM-150-0900	9.0	18.0	1350W	£263.53
CBM-150-1000	10.0	20.0	1500W	£289.43
CBM-150-1200	12.0	24.0	1800W	£345.77
CBM-150-1500	15.0	30.0	2250W	£426.70
Product code	Description			
CBM-INS-0006	6m ² of protective insulation			£22.02
CBM-ALU-TAPE	Electrically conductive tape 20m x 40mm			£10.36
CBM-OVE-0280	2.88m ² of 7mm Combymat overlay boards			£49.86
ACC-TAP-DUCT	50m of duct tape for insulation boards			£7.77



Combymat Overlay Boards

For Alternative Floor Coverings

Combymat Overlay Boards – use Combymat heating mats beneath carpet and vinyl floors without requiring levelling compounds

- **Allows the use of Combymat with carpet and vinyl floor coverings**
- **No wet trade – no need for levelling compounds**
- **Provides a protective floating floor layer above the heating system**
- **Manufactured in the Netherlands**

Heat Mat's Overlay Boards allow the fast-to-fit Combymat system to be safely used with floating floors such as carpet, vinyl and linoleum. The boards are a precision cut combination of 3mm and 4mm panels with a contact adhesive that enables a straightforward installation.

As long as the original floor was reasonably flat before the heating mats were laid, the boards will provide a flat and even surface for the floor covering to be installed onto.

The boards are not suitable for use in wet areas as they must remain totally dry. They can not be used in bathrooms or any room where water may rest on the floor surface for any period of time.

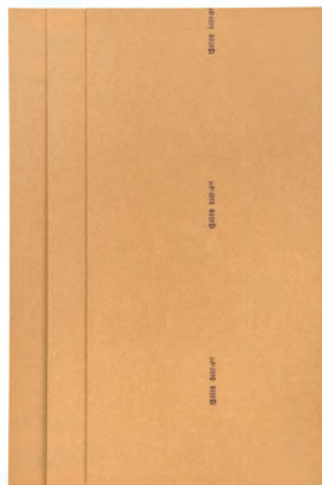

Underfloor Heating Cables



Heat Mat's high-quality underfloor heating cables are a flexible solution for heating any room shape or size

- Flexible install – for awkward shapes
- High-quality, robust 3mm cable
- Perfect for use with Heat Mat's decoupling membrane
- Cost-effective underfloor heating
- Ultra-thin cable for low build height
- Lifetime warranty

The ultra-thin heating cable system includes a 3mm wire that can easily be fitted into small or complicated spaces, e.g. bathrooms with fixed units.

Adjusting the cable spacing during installation can alter the output of the 3mm cable system, providing concentrated heat where it is most needed such as in draughty doorways.

Product code	Unit power (W)	Length (m)	Coverage at 200W/m ² c-c 7cm	Coverage at 150W/m ² c-c 9.25cm	Coverage at 100W/m ² c-c 14cm	Price (RTP ex. VAT)
PKC-3.0-0130	130W	9.2	0.6 m ²	0.9 m ²	1.2 m ²	£74.00
PKC-3.0-0212	212W	15	1.0 m ²	1.4 m ²	2.1 m ²	£93.00
PKC-3.0-0316	316W	23	1.6 m ²	2.1 m ²	3.2 m ²	£113.00
PKC-3.0-0407	407W	30	2.0 m ²	2.7 m ²	4.0 m ²	£131.00
PKC-3.0-0518	518W	37	2.6 m ²	3.4 m ²	5.2 m ²	£165.00
PKC-3.0-0577	577W	41	2.9 m ²	3.8 m ²	5.8 m ²	£187.00
PKC-3.0-0719	719W	51	3.6 m ²	4.8 m ²	7.2 m ²	£210.00
PKC-3.0-0855	855W	61	4.2 m ²	5.7 m ²	8.4 m ²	£246.00
PKC-3.0-1086	1086W	78	5.4 m ²	7.2 m ²	10.8 m ²	£310.00
PKC-3.0-1207	1207W	86	6.0 m ²	8.0 m ²	12.0 m ²	£334.00
PKC-3.0-1350	1350W	97	6.8 m ²	9.0 m ²	13.6 m ²	£340.00
PKC-3.0-1507	1507W	108	7.6 m ²	10.0 m ²	15.2 m ²	£374.00
PKC-3.0-1772	1772W	128	8.9 m ²	11.8 m ²	17.8 m ²	£417.00
PKC-3.0-1983	1983W	141	9.9 m ²	13.2 m ²	19.8 m ²	£475.00
PKC-3.0-2250	2250W	160	11.2 m ²	15.0 m ²	22.4 m ²	£529.00
PKC-3.0-2406	2406W	171	12.0 m ²	16.0 m ²	24.0 m ²	£558.00



Tiling onto a cracked floor or green screed couldn't be easier. Use Nicobond D-Mat 3L, the reliable solution for tiling to problem substrates. Perfect for use with Undertile Heating

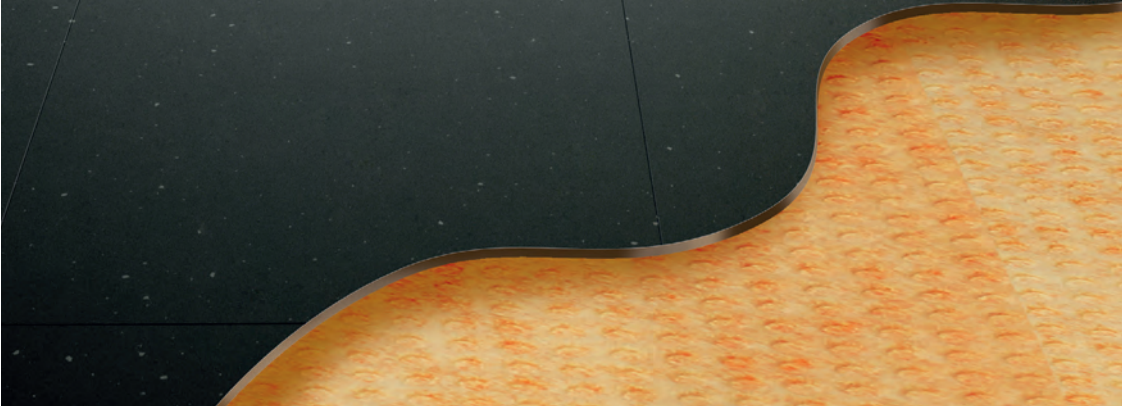

The perfect partnership...

Underfloor heating has the potential to cause cracking in tiles. Nicobond D-Mat 3L is compatible with both underfloor and undertile heating systems.

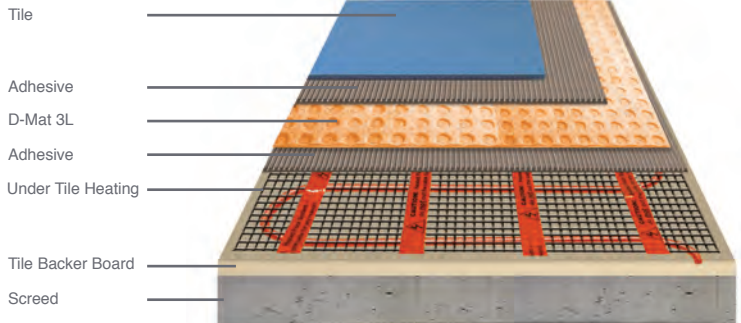

Thermostats

NGTouch



An easy-to-use 16Amp touchscreen thermostat



- Easy to install and use
- Features Eco Mode for energy saving
- Program 4 or 6 heating events per day
- Compatible with all brands of electric underfloor heating
- BEAB Approved and made in Denmark
- Lifetime warranty

The NGTouch is a contemporary touchscreen thermostat with a full colour resistive touchscreen. A number of easy-to-use lifestyle modes are available for quick temperature control, including comfort, holiday, frost protection and boost.



QR Code Readout – This readout provides energy usage graphs and helps diagnose any issues with the thermostat. The QR code can be scanned with a smartphone, and the data can be emailed to Heat Mat's technical support team via support@heatmat.co.uk if required. **Scan the QR Code to see for yourself.**

Product code	Description	Price (RTP ex. VAT)
NGT-2.0-STND	Polar white with colour screen – 16A	£82.88
NGT-2.0-SILV	Silver with colour screen – 16A	£86.12



You Tube Search 'NGTouch' on our YouTube channel for instructional videos.

Premium thermostat finishes

NGTouch Premium



The NGTouch thermostat can be combined with stylish square frames in premium materials such as polished chrome, brushed aluminium or glass

- Luxurious finishes
- Silver, black or white thermostat fascias
- Mix and match colours and materials



TOU-SIL-CHRM



TOU-BLK-BLK



TOU-SIL-MINT



TOU-SIL-GDAU



TOU-WHT-WHTE



TOU-SIL-SSTL



Product code	Description	Price (RTP ex. VAT)
TOU-BLK-SSTL	Black / Stainless Steel NGTouch	£112
TOU-SIL-SSTL	Silver / Stainless Steel NGTouch	£112
TOU-WHT-SSTL	White / Stainless Steel NGTouch	£112
TOU-BLK-ALUM	Black/ Aluminium NGTouch	£112
TOU-SIL-ALUM	Silver/ Aluminium NGTouch	£112
TOU-WHT-ALUM	White/ Aluminium NGTouch	£112
TOU-BLK-GDAU	Black / Gold Aluminium NGTouch	£112
TOU-SIL-GDAU	Silver / Gold Aluminium NGTouch	£112
TOU-WHT-GDAU	White / Gold Aluminium NGTouch	£112
TOU-BLK-BLAU	Black / Black Aluminium NGTouch	£112
TOU-SIL-BLAU	Silver / Black Aluminium NGTouch	£112
TOU-WHT-BLAU	White / Black Aluminium NGTouch	£112
TOU-BLK-CHRM	Black / Chrome NGTouch	£112
TOU-SIL-CHRM	Silver / Chrome NGTouch	£112
TOU-WHT-CHRM	White / Chrome NGTouch	£112
TOU-BLK-BRSS	Black / Brass NGTouch	£112
TOU-WHT-BRSS	White / Brass NGTouch	£112
TOU-BLK-BLK	Black / Black Glass NGTouch	£112
TOU-SIL-BLK	Silver / Black Glass NGTouch	£112
TOU-WHT-BLK	White / Black Glass NGTouch	£112
TOU-BLK-WHTE	Black / White Glass NGTouch	£112
TOU-SIL-WHTE	Silver / White Glass NGTouch	£112
TOU-WHT-WHTE	White / White Glass NGTouch	£112

Thermostats

NGTouch WiFi



The NGTouch WiFi is an easy-to-use touchscreen thermostat allowing remote temperature control from an app

- **WiFi enabled**
- **Log-in on multiple devices**
- **Use the App or control using the touchscreen**
- **Includes comfort mode, holiday mode, boost, eco and frost protection**
- **See your energy use in kW and £'s over a week, a month or a year**
- **Switch to manual for simple temperature control**
- **Combine the NGTouch WiFi with premium frames in materials such as aluminium, glass and chrome**

The NGTouch WiFi thermostat offers remote operation from anywhere in the world via a companion App. This simple-to-use thermostat has various lifestyle modes including comfort, frost protection, holiday and boost for an hour of full-power heat.

This wireless control enables all aspects of the set-up and operation of the NGTouch WiFi thermostat to be carried out via the straightforward App.

Connection to your WiFi network is simple and trouble free, there is no need for a separate hub and the set-up of each thermostat takes seconds. The NGTouch WiFi electric underfloor heating thermostat can be used to control any of Heat Mat's underfloor heating systems.

Product code	Description	Price (RTP ex. VAT)
NGT-2.0-WIFI	NGTouch WiFi version	£118.39
WIF-BLK-XXXX	NGTouch WiFi with black fascia and premium frame	£175
WIF-SIL-XXXX	NGTouch WiFi with silver fascia and premium frame	£175
WIF-WHT-XXXX	NGTouch WiFi with white fascia and premium frame	£175

 **Made in Denmark**

Thermostats

NGT / TPS

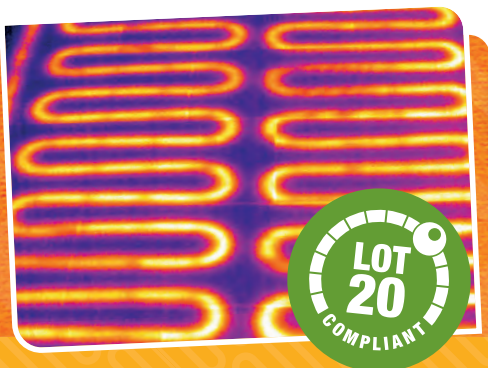

NGT Digital Programmable Thermostat

An easy-to-use programmable thermostat

- Displays energy usage
- Available in ivory
- Choose from 4 or 6 programmable events each day

The NGT learns the heat characteristics of your room to automatically control both room and floor temperature. This thermostat ensures maximum comfort for minimum



Product code	Description	Price (RTP ex. VAT)
NGT-567-0010	Ivory digital thermostat	£82.88



TPS Manual Thermostat

Easy-to-use 16Amp manual digital thermostat

- Simple-to-use manual controller
- The ideal choice when a timer/program mode is not usually required
- This controller includes a simple pre-set timer mode to ensure Lot20 compliance

The TPS is simple to control using the up and down arrows to change the target floor or air temperature. The TPS monitors both the room and floor temperature and includes a frost



Product code	Description	Price (RTP ex. VAT)
TPS-345-0031	Manual digital thermostat – Lot20 Compliant - 16A	£60.22



demista™ by Heat Mat – Mirror demister pads automatically keep mirrors steam free

- **Low power consumption**
- **Wire through the lighting circuit**
- **No thermostat required**
- **12V SELV and bespoke options available**

Heat Mat's range of mirror demisters, manufactured by demista™, automatically keep mirrors steam free after bathing or showering allowing mirrors to be used at all times. In addition to the 17 stocked sizes of 230V demisters available, Heat Mat also offer over 400 further sizes in 230V, 110V, 24V and 12V/SELV ratings as special order items (delivery timescale usually 3 working days).

Mirror demisters are available for all bathroom zones and can easily be wired through the lighting circuit so they only heat when the bathroom is in use.

Backed up by Heat Mat's no-quibble lifetime warranty

- **Most orders can be supplied next working day direct from stock**
- **Quantity discounts available on orders of 5 or more**
- **Competitive project pricing applied for orders over 150 units**
- **Bespoke sizes available**

Mirror demisters are ideal for hotel developments or projects with multiple bathrooms. We offer custom-made sizes of mirror demisters as part of our bespoke service.

Mirror Demisters



Product code	Size	Wattage	Price (RTP ex. VAT)
Stocked sizes of 230V mirror demisters			
HM7015L025	150mm x 250mm	6W	£23.31
HM7020L025	200mm x 250mm	9W	£23.96
HM7030L025	300mm x 250mm	13W	£24.61
HM7030L081	300mm x 810mm	45W	£34.32
HM7040L025	400mm x 250mm	18W	£25.90
HM7040L045	400mm x 450mm	33W	£29.79
HM7040L081	400mm x 810mm	61W	£36.91
HM7040L101	400mm x 1010mm	76W	£40.79
HM7050L053	500mm x 530mm	50W	£32.38
HM7050L077	500mm x 770mm	73W	£38.85
HM7050L105	500mm x 1050mm	100W	£45.97
HM7050L149	500 x 1490mm	142W	£28.49
HM7060L029	600mm x 290mm	32W	£44.68
HM7070L077	700mm x 770mm	103W	£47.92
HM7070L089	700mm x 890mm	120W	£51.15
HM7070L101	700mm x 1010mm	136W	£54.39
HM7070L113	700mm x 1130mm	152W	£60.22
HM7070L129	700mm x 1290mm	174W	£66.33



Wall Heating Mats & Heat Mat Bespoke

Wall heating mats



Wall heating mats are an excellent secondary heat source in bathrooms, en-suites and wetrooms. The mats can be used to speed up the drying of walls, or be fitted instead of heated towel rails.

- Ideal for tiled bathrooms, en-suites and wetrooms
- Space saving alternative to radiators
- Dry towels instead of a heated towel rail
- Suitable for hotels, spas and changing rooms
- Install as an alternative to radiators
- Supplement a primary heat source

Product code	Description	Price (RTP ex. VAT)
WHM-160-0070	0.7m ² 120W 0.5 x 1.4m Wall heating mat	£33.02
WHM-160-0110	1.1m ² 179W 0.5 x 2.2m Wall heating mat	£49.21
WHM-160-0150	1.5m ² 245W 0.5 x 3.0m Wall heating mat	£67.34
WHM-160-0200	2.0m ² 327W 0.5 x 4.0m Wall heating mat	£80.94
WHM-160-0230	2.3m ² 380W 0.5 x 4.6m Wall heating mat	£95.83
WHM-160-0280	2.8m ² 457W 0.5 x 5.6m Wall heating mat	£110.08
WHM-160-0310	3.1m ² 509W 0.5 x 6.2m Wall heating mat	£123.03

Product code	Description	Price (RTP ex. VAT)
WHM-200-0060	0.6m ² 130W 0.5 x 1.2m Wall heating mat	£35.61
WHM-200-0100	1.0m ² 208W 0.5 x 2.0m Wall heating mat	£55.69
WHM-200-0160	1.6m ² 310W 0.5 x 3.2m Wall heating mat	£71.23
WHM-200-0200	2.0m ² 405W 0.5 x 4.0m Wall heating mat	£88.06
WHM-200-0260	2.6m ² 512W 0.5 x 5.2m Wall heating mat	£107.49
WHM-200-0280	2.8m ² 576W 0.5 x 5.6m Wall heating mat	£118.49
WHM-200-0350	3.5m ² 719W 0.5 x 7.0m Wall heating mat	£144.39



Nicobond Screedpro Level Floor
A premium, self smoothing, pre-aggregated, fast setting compound which can be laid up to 50mm in one single application providing an even base suitable for ceramic /porcelain and natural stone tile installations.

Driveway, Walkway and Ramp De-icing

- Fully automated clearance of ice, snow and frost
- Improved safety for vehicles and pedestrians
- Maintain access by keeping loading ramps, parking ramps and entrances clear
- These cables can accept hot asphalt laid directly onto them ensuring a fast installation



50W driveway heating cables

Product code	Description	Length (m)	Price (RTP ex. VAT)
ICE-50W-1050	21m Driveway heating cable – 4.2m ² at 250W – 15m coldtail	21	£238.00
ICE-50W-4250	85m Driveway heating cable – 17.0m ² at 250W – 15m coldtail	85	£486.00
ICE-50W-DRUM	Returnable aluminium drum for 50W driveway heating cable		£167.00

15m coldtail supplied as standard, factory extensions £5.00 per metre

Driveway track and temporary heating mats (non-stock item, please call for manufacture lead time)

Product code	Description	Length (m)	Price (RTP ex. VAT)
ICE-040-0600	6m x 0.4m Driveway heating mat 300W/sqm	6	£167.00
ICE-040-0800	8m x 0.4m Driveway heating mat 300W/sqm	8	£201.00
ICE-040-1000	10m x 0.4m Driveway heating mat 300W/sqm	10	£235.00
ICE-040-1200	12m x 0.4m Driveway heating mat 300W/sqm	12	£268.00
ICE-040-1400	14m x 0.4m Driveway heating mat 300W/sqm	14	£291.00
ICE-040-1600	16m x 0.4m Driveway heating mat 300W/sqm	16	£347.00
ICE-040-1800	18m x 0.4m Driveway heating mat 300W/sqm	18	£370.00
ICE-040-2000	20m x 0.4m Driveway heating mat 300W/sqm	20	£425.00
ICE-100-0300	3m x 1m Temporary outdoor heating mat 270W/sqm	3	£983.00

Thermostats and sensors

Product code	Description	Price (RTP ex. VAT)
FRO-10A-STAT	2.3kW Snow melting thermostat without moisture detection option	£116.00
FRO-16A-STAT	3.6kW Snow melting thermostat with moisture detection option – single zone	£264.00
FRO-48A-STAT	11kW Snow melting thermostat with moisture detection option – dual zone	£441.00
FRO-GRO-TEMP	External ground/pipe temperature sensor	£50.00*
FRO-GRO-SENS	External moisture and ground temperature sensor with 5m tail	£353.00
FRO-GRO-SENS-25M	External moisture and ground temperature sensor with 25m tail	£529.00

Roof & Gutter



For your roofs

- Ensure valleys and drainage channels are kept free of ice and snow to allow melt water to drain off the roof
- Prevent water ingress caused by snow build-up
- Trace heating and constant wattage systems available

For your gutters

- Fully automated protection to prevent ice build-up in gutters and ensure walkways below are safe from falling icicles
- Prevent gutters collapsing and water ingress into buildings
- Ensure melt water can drain easily

Roof & Gutter heating cables are made to order.

Roof and gutter thermostats and sensors

Product code	Description	Price (RTP ex. VAT)
FRO-10A-STAT	2.3kW Snow melting thermostat without moisture detection option	£116.00
FRO-16A-STAT	3.6kW Snow melting thermostat with moisture detection option – single zone	£264.00
FRO-16A-GSTA	3.6kW Gutter heating thermostat with air temperature sensor	£169.00
FRO-48A-STAT	11kW Snow melting thermostat with moisture detection option – dual zone	£441.00
FRO-TEM-SENS	External air temperature sensor	£64.00*
FRO-GUT-SENS	Gutter moisture detection sensor	£254.00

Gutter accessories

Product code	Description	Price (RTP ex. VAT)
FRO-GUT-BEAM	Suspension beam for gutter downpipe chain	£8.00*
FRO-GUT-CHAI	1m Chain for downpipe heating cable – 22 pieces	£5.00*
FRO-GUT-DOWN	Cable guide for downpipe heating cable – 2 per metre	£1.00*
FRO-GUT-GUID	Cable guides for gutter heating cable – 1 per metre	£1.00*

*See page 2 for delivery charge information

Trace Heating



- Frost protection of water pipes and condensate pipes
- Intelligent self-limiting cables designed to pinpoint where heat is needed
- A wide range of domestic and commercial uses including temperature maintenance, condensate pipe protection and gutter protection

Product code	Description	Price (RTP ex. VAT) 1-9m	Price (RTP ex. VAT) 10-99m	Price (RTP ex. VAT) 100-499m	Price (RTP ex. VAT) 500m plus
ACC-CAB-0012 [†]	12W/m Self-limiting trace heating cable	£11.40	£10.40	£9.40	£8.40*
ACC-CAB-0017 [†]	17W/m Self-limiting trace heating cable	£11.65	£10.65	£9.65	£8.65*
ACC-CAB-0023 [†]	23W/m Self-limiting trace heating cable	£11.90	£10.90	£9.90	£8.90*
ACC-CAB-0028 [†]	28W/m Self-limiting trace heating cable	£12.15	£11.15	£10.15	£9.15*
ACC-CAB-EX12 [†]	12W/m EX rated Self-limiting trace heating cable	£14.50	£13.50	£13.00	£12.50*
ACC-CAB-EX17 [†]	17W/m EX rated Self-limiting trace heating cable	£14.75	£13.75	£13.25	£12.75*
ACC-CAB-EX23 [†]	23W/m EX rated Self-limiting trace heating cable	£15.00	£14.00	£13.50	£13.00*
ACC-CAB-EX28 [†]	28W/m EX rated Self-limiting trace heating cable	£15.25	£14.25	£13.75	£13.25*
ACC-CWP-0011 [†]	11W/m Specialist in water pipe trace heating – For frost protection				£18.00*

[†]These above products are non-returnable

Hot water temperature maintenance cable

Product code	Description	Price (RTP ex. VAT)
ACC-CAB-MAIN	Hot water temperature maintenance trace heating cable – per metre	£23.00*

Trace heating accessories

Product code	Description	Price (RTP ex. VAT)
ACC-CAB-CON	Trace heating connection kit	£8.00*
CBM-ALU-TAPE	20m x 40mm electrically conductive aluminium tape	£15.00*
ACC-CAB-GLAN	IP68 Cable gland for junction box	£4.00*
ACC-TRA-BRSP	Brass fitting for internal trace heating	£24.00*
FRO-10A-STAT	2.3kW Snow melting thermostat without moisture detection option	£116.00
TRA-20A-STAT	IP67 Industrial trace heating thermostat – 20A	£201.00
TRA-20A-110V	IP67 110V Industrial trace heating thermostat – 20A	£201.00
TRA-087-MBRK	87mm Junction box mounting brackets	£11.00*
TRA-125-MBRK	125mm Thermostat/junction box mounting brackets	£23.00*
TRA-50M-GLFB	50m x 25mm Glass fibre fixing tape	£15.00*
TRA-JUN-BUDG	IP55 Budget T piece junction box – 87mm	£15.00*
TRA-JUN-LARG	IP55 Large junction box for multiple connections – 125mm	£42.00*
TRA-JUN-PREM	IP55 Premium T piece junction box – 87mm	£28.00*

*See page 2 for delivery charge information

Heat Mat PipeGuard



Designed to prevent frozen condensate pipes in the most extreme conditions, Heat Mat PipeGuard is a simple-to-fit solution which stops frozen, cracked and damaged pipes, and ensures water keeps flowing down to -25°C .

- **Prevent burst or frozen pipes in winter**
- **Monitors pipe temperature instead of air temperature to minimise running costs**
- **Ready-made unit with integrated thermostat, simply connect to power supply**

Product code	Description	Unit power (W)	Size (m)	Price (RTP ex. VAT)
ACC-FRO-0019	1.4m Heat Mat PipeGuard 19W	19	1.4	£64.00*
ACC-FRO-0026	2.0m Heat Mat PipeGuard 26W	26	2.0	£71.00*
ACC-FRO-0039	3.0m Heat Mat PipeGuard 39W	39	3.0	£76.00
ACC-FRO-0053	4.0m Heat Mat PipeGuard 53W	53	4.0	£83.00
ACC-FRO-0065	5.0m Heat Mat PipeGuard 65W	65	5.0	£88.00
ACC-FRO-0107	8.0m Heat Mat PipeGuard 107W	107	8.0	£94.00
ACC-FRO-0140	10.5m Heat Mat PipeGuard 140W	140	10.5	£106.00
ACC-FRO-0185	14.0m Heat Mat PipeGuard 185W	185	14.0	£118.00
ACC-FRO-0246	18.5m Heat Mat PipeGuard 246W	246	18.5	£140.00
ACC-FRO-0300	22.5m Heat Mat PipeGuard 300W	300	22.5	£154.00
ACC-FRO-0474	38.0m Heat Mat PipeGuard 474W	474	38.0	£235.00
ACC-FRO-0567	45.0m Heat Mat PipeGuard 567W	567	45.0	£270.00



Undertile Heating

for the Trade

ONLY
£129.99
 each



Warmup

6IE Wi-fi Thermostat

Warmup Stickymat 150W/m²

Undertile heating mat suitable for insulated rooms to take the chill off a tiled floor



FROM
£73.95
 each

Code	m ²	Watts	Price
N2539070	1	150	£73.95
N2539072	1.5	225	£92.45
N2539074	2	300	£101.70
N2539076	2.5	375	£124.83
N2539078	3	450	£143.33
N2539080	3.5	525	£161.83
N2539082	4	600	£175.70
N2539084	4.5	675	£194.20
N2539086	5	750	£217.33
N2539088	6	900	£254.33
N2539090	7	1050	£291.33
N2539092	8	1100	£319.08
N2539094	9	1250	£346.83
N2539096	10	1400	£374.58
N2539098	11	1550	£393.08
N2539100	12	1700	£430.08
N2539102	15	2250	£541.08

Warmup Stickymat 200W/m²

Undertile heating mat suitable for high heat loss rooms or as use as the sole heating source for an insulated room.

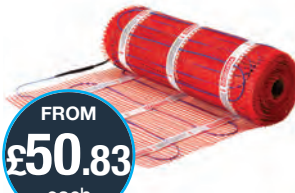

FROM
£50.83
 each

Code	m ²	Watts	Price
2SM0.5	0.5	100	£50.83
2SM1	1	200	£78.58
2SM1.5	1.5	300	£97.08
2SM2	2	400	£110.95
2SM2.5	2.5	500	£134.08
2SM3	3	600	£157.20
2SM3.5	3.5	700	£175.70
2SM4	4	800	£194.20
2SM4.5	4.5	900	£212.70
2SM5	5	1000	£242.77
2SM6	6	1200	£272.83
2SM7	7	1400	£314.45
2SM8	8	1600	£346.83
2SM9	9	1800	£369.95
2SM10	10	2000	£397.70
2SM15	15	3000	£582.70

Warmup Dual Wire Undertile Heater

An ultra-thin, dual-core heating wire that is flexible, easy to install and will not raise floor levels. Ideal for more irregular shaped areas.



FROM
£92.45
 each

Code	m ²	Watts	Price
N2539018	1.5 - 2.4	300	£92.45
N2539019	2.5 - 3.4	400	£101.70
N2539020	3.5 - 4.4	600	£147.95
N2539021	4.5 - 5.9	800	£194.20

Warmup DCM-Pro Cable

Loose undertile heating cable designed to be used in conjunction with DCM-Pro mat



FROM
£78.58
each

Code	m2	Watts	Price
N2539252	1	150	£78.58
N2539254	1.5	225	£87.83
N2539256	2	300	£101.70
N2539258	2.5	375	£120.20
N2539260	3	450	£129.45
N2539262	3.5	525	£147.95
N2539264	4	600	£166.45
N2539266	4.5	675	£184.95
N2539268	5	750	£208.08
N2539270	6	900	£231.20
N2539272	7	1050	£257.10
N2539274	8	1200	£286.70
N2539276	9	1350	£319.08
N2539278	10	1500	£357.93
N2539280	12	1800	£402.33
N2539282	14	2100	£457.83
N2539284	16	2400	£517.95

Warmup Inscreed Cable

Excellent for installation within screeded floors of any size. Once installed, the heated screed can be covered with any flooring. (For further coverage information please call your local N&C Branch).



FROM
£39.94
each

Code	m2	Watts	Price
WIS180	1.2	180	£39.94
WIS280	1.9	280	£55.92
WIS390	2.6	390	£63.91
WIS500	3.3	500	£75.90
WIS650	4.3	650	£91.88
WIS760	5.1	760	£95.87
WIS1000	6.7	1000	£116.52
WIS1200	8	1200	£136.49
WIS1460	9.7	1460	£160.46
WIS1550	10.3	1550	£164.46
WIS1770	11.8	1770	£177.11
WIS2070	13.8	2070	£191.75
WIS2600	17.3	2600	£232.37
WIS3140	20.9	3140	£268.99
WIS3370	22.5	3370	£284.97

Warmup DCM-Pro Self-adhesive Mat

A self-adhesive de-coupling mat that accepts the DCM-Pro undertile heating cable



FROM
£18.49
m²

Code	m2	m	Price
N2539286	1	1 x 1	£18.49
N2539288	15	15 x 1	£208.08

Warmup DCM Pro Waterproofing Tape

Waterproofing tape to create a waterproof barrier in conjunction with DCM Pro Undertile Heating System.



ONLY
£17.63
each

Code	mm	m	Price
DCM-T-10	120	10	£17.63

Warmup DCM Pro Waterproof Tape External Corner

Waterproofing external corner to create a waterproof barrier in conjunction with DCM Pro Undertile Heating System. 10m



ONLY
£3.82
each

Code	mm	m	Price
DCM-R-E	120 x 120	n/a	£3.82

Warmup Foil Heater 140W/m²

A streamlined electric radiant floor heater designed for use with carpet, vinyl, wood and other floating floors.



FROM
£60.07
each

Code	m2	Watts	Price
WLFH-140W/140	1	140	£60.07
WLFH-140W/210	1.5	210	£73.94
WLFH-140W/280	2	280	£87.82
WLFH-140W/420	3	420	£134.08
WLFH-140W/560	4	560	£166.45
WLFH-140W/700	5	700	£203.45
WLFH-140W/840	6	840	£240.44
WLFH-140W/980	7	980	£277.45
WLFH-140W/1120	8	1120	£319.08
WLFH-140W/1260	9	1260	£360.70
WLFH-140W/1400	10	1400	£397.70
WLFH-140W/1680	12	1680	£471.70



Warmup 6IE Wi-fi Thermostat

The world's first underfloor heating thermostat with a smartphone style touchscreen. Easy control of the heating is just a swipe away.

SmartGeo technology
Helps save over 400 on energy bills
Worlds first UFH controller
with Smartphone touchscreen
Compatible with all Warmup Underfloor Heating Systems



ONLY
£129.99
each

Code	mm	Colour	Price
N2539055	90 x 115 x 39	Onyx Black	£129.99
N2539056	90 x 115 x 39	Bright Porcelain	£129.99

Warmup Element Wi-fi Thermostat

Designed for simplicity, the Element makes efficient smart heating control accessible to everyone



ONLY
£90
each

NOTE: Available Autumn 2021

Code	mm	Colour	Price
N2539058	86 x 86 x 16	Black	£90.00
N2539059	86 x 86 x 16	White	£90.00

Warmup 3IE Energy Monitoring Thermostat

The world's first fully interactive, touch technology, energy-monitor thermostat features an easy-to-use interface, eliminating complicated instruction manuals

FROM
£85
each

Code	mm	Colour	Price
N2539040	90 x 110 x 30	Piano Black	£85.00
N2539041	90 x 110 x 30	Classic Cream	£85.00
N2539042	90 x 110 x 30	Silver Grey	£90.00
WU-3IE-WB	90 x 110 x 30	Warm Berry	£90.00
WU-3IE-MB	90 x 110 x 30	Madison Blue	£90.00
WU-3IE-LG	90 x 110 x 30	Leaf Green	£90.00
WU-3IE-DP	90 x 110 x 30	Deep Pink	£90.00



Warmup Elements Tempo Programmable Thermostat

The Tempo thermostat enables end users to choose the time as easily as they would with a watch or clock and quickly set their programs

ONLY
£63
each

Code	mm	Colour	Price
N2539032	90 x 113 x 23	Porcelain White	£63.00
N2539033	90 x 113 x 23	Piano Black	£63.00



Warmup Manual Thermostat Controller

No need to set-up a programme, the Warmup MSTAT is simple and intuitive, allowing you to set your comfort temperature in seconds with a twist of a dial.

ONLY
£55.45
each

Code	mm	Colour	Price
MSTAT	86 x 86 x 50	White	£55.45



Warmup Insulated Underlay

A thin polystyrene insulation barrier for use with Warmup's Foil Heater.

FROM
£27.70
each

Code	mm	m2	Price
WIU2.5	1200 x 2083 x 6	2.5	£27.70
WIU5.0	1200 x 4166 x 6	5	£46.20
WIU10.0	1200 x 8332 x 6	10	£83.20
WIU25.0	1200 x 2083 x 6	25	£184.95

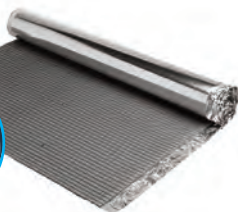

Nicobond Tile Backer Board & Construction Panel

A polystyrene hard foam core and coated with a glass-fibre mesh reinforced cement based mortar layer on both sides

FROM
£10.26
each

Code	m	Price
N2553006	1.2 x 0.6 x 6mm	£10.26
N2553010	1.2 x 0.6 x 10mm	£10.26
N2553013	1.2 x 0.6 x 12mm	£11.19
N2553021	1.2 x 0.6 x 20mm	£13.06
N2553030	2.4 x 0.6 x 30mm	£32.66
N2553040	2.4 x 0.6 x 40mm	£37.32
N2553050	2.4 x 0.6 x 50mm	£42.92
N2553060	2.4 x 0.6 x 60mm	£47.59
N2553070	2.4 x 0.6 x 70mm	£63.46
N2553084	2.4 x 1.2 x 12.5mm	£46.66



Nicobond Hammer Set Galvanised Backer Board Fixings

Use with Nicobond Tile Backer Board when dot and dab fixing to solid wall substrates.

FROM
£5.83
pack 10



Nicobond Jointing Tape

48mm wide self adhesive jointing tape for backer board edges.

ONLY
£6.99
each



Code	mm	Price
N2553108	80 x 8	£5.83
N2553109	110 x 8	£8.33

Code	m	Price
N2552120	45	£6.99

Warmup Dual Overlay System

Dual Overlay is a free-floating subfloor for use with the Foil Heater under carpet, vinyl and linoleum floor finishes.

ONLY
£60.08
each



Code	mm	m2	Price
WDO	2400x14x1200	2.88	£60.08

Warmup Mirror Demisters

A safe and easy way to remove steam from bathroom mirrors

ONLY
£32.33
each

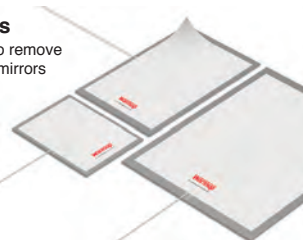

Code	mm	watts	Price
MD-LRG1	560 x 720	14.1	£55.45
MD-MED1	360 x 560	33.3	£41.58
MD-SML1	260 x 360	66	£32.33

Warmup Single Bar Towel Rails

Single-bar heated towel rails provide great flexibility and are available in two style options and three finishes. 3m cold tail. Tulsi - round bar. Burdock - square bar

FROM
£65.25
each



Code	mm	Finish	Price
N2539207	650 x 100 x 32	Polished Round	£70.57
N2539204	650 x 100 x 40	Polished Square	£65.25
N2539208	650 x 100 x 32	Brushed Round	£76.57
N2539205	650 x 100 x 40	Brushed Square	£71.91

Warmup Multiple Bar Towel Rails

Towel rails manufactured using high quality stainless steel (SS304) making them resistant to staining and corrosion, ideal for bathroom environments. 3m cold tail. 4, 6 or 8 bar in two finishes

FROM
£135.83
each



Code	mm	Finish	Price
HTR-4ROPO	520 x 500 x 120	Polished Round	£135.83
HTR-4SQPO	435 x 525 x 120	Polished Square	£151.81
HTR-6ROPO	600 x 650 x 120	Polished Round	£203.45
HTR-6SQPO	600 x 650 x 120	Polished Square	£212.70
HTR-8ROPO	800 x 530 x 135	Polished Round	£295.95
HTR-8SQPO	912 x 620 x 120	Polished Square	£323.70

Warmup Stickymat 3D Wall Heating

Using wall heating alongside a Warmup floor heater is the future of energy-efficient home heating and the StickyMat 3D Wall Heating System features state-of-the-art radiant technology to enhance the comfort and warmth of your bathroom. All 500mm wide. All products 200w/m²

Code	m	Width mm	Price
N2539200	0.5	100	£60.08
N2539201	1	200	£97.08
N2539202	1.5	300	£120.20
N2539203	2	400	£134.08



FROM
£60.08
each

PPE and Workwear

for the Trade

General Purpose Gloves

ONLY
£5.90
 box of 25 pairs
 H9901700



Hi Visibility Vests

Hi visibility vest in yellow with a velcro fastening front. Made 100% polyester and incorporates a 50mm reflective tape



ONLY
£2.15
 each

Code	Size	Price
H9900458	Large	£2.15
H9900459	X-Large	£2.15

Overshoes

Bag of 50 pairs. Blue polyethylene overshoes to help protect newly laid flooring surfaces from dirt transfer.



ONLY
£3.15
 each

Code	Size	Price
H9996999	One Size	£3.15

Premium Safety Helmet

High quality premium safety helmet. Strong polyethylene construction. Unvented and conforms to EN397



ONLY
£6.28
 each

Code	Size	Price
H9900362	One Size	£6.28

Premium Ear Defenders

A durable and lightweight premium ear defender with a high impact ABS construction. SNR rated to 27db and conforms to EN352-1



ONLY
£3.64
each

Code	Size	Price
H9900368	One Size	£3.64

Tapered Foam Ear Plugs. Pack of 6



ONLY
£2.83
each

Code	Size	Price
H9901080	Pack of 6	£2.83

Tapered Foam Ear Plugs with Cord. Pack of 6



ONLY
£3.72
each

Code	Size	Price
H9901081	Pack of 6	£3.72

Pressure Reducing Silicon Earplugs. Pack of 6



ONLY
£5.79
each

Code	Size	Price
H9901082	Pack of 6	£5.79

Silicon Ear Plugs. Pack of 6



ONLY
£5.26
each

Code	Size	Price
H9901083	Pack of 6	£5.26

Direct Vent Safety Goggle

Tough polycarbonate clear UV resistant lens and a soft vinyl construction



ONLY
£1.16
each

Code	Size	Price
H9900371	One Size	£1.16

Visitor Safety Spectacles

A wrap around panoramic vision lens with a comfortable wide frame and integral brow shield.



ONLY
£1.24
each

Code	Size	Price
H9900375	One Size	£1.24

FFP2NR Moulded Face Mask Single Pack

FFP2NR moulded mask for comfort during prolonged use



ONLY
96p
each

Code	Size	Price
H9900918	One Size	96p

Huge Stocks

We hold over 60,000 products in stock, ready for delivery or collection

Red - General Purpose

General purpose gloves with 4.5mil thickness, 240mm overall length, ideal for engineering, automotive & DIY



ONLY
£5.90
each

Code	Size	Price
H9901700	Box of 25 pairs	£5.90

Pro Latex Grip Gloves

10 gauge high grade cotton liner with a professional quality natural latex.



ONLY
£1.24
each

Code	Size	Price
H9900393	Size 9 (Large)	£2.14
H9900394	Size 10 (X-Large)	£2.14

PU Flex Gloves

Light duty gloves with a seamless 13 gauge knitted nylon liner.



ONLY
98p
each

Code	Size	Price
H9900403	Size 8 (Medium)	98p
H9900406	Size 11 (Xx-Large)	98p

Nitrile Flex Gloves

Nitrile dipped palm designed for extra abrasion resistance. Oil repellent coating



FROM
75p
each

Code	Size	Price
H9900413	Size 9 (Large)	75p

Rubi Lumbar Protector

Recommended to avoid low-back injuries when loading weight or maintaining fixed positions. With vertical reinforcement in the lower-back area. Side devices to adjust the pressure at the time of stress.



ONLY
£17.95
each

Code	Size	Price
80913	Large (96-104cm)	£17.95
80914	X Large (104-112cm)	£17.95

Rubi Ear protector

Comfortable and effective protection for high noise environments. Conforms to EN352-1.



ONLY
£7.50
each

Code	Size	Price
80903	n/a	£7.50

Rubi Protective goggles

Field of use; Liquids and coarse dust particles. Mechanical resistance to particles at great speed and half energy. Adjustable ventilation points to prevent lens fog up. Conforms to EN166.



ONLY
£7
each

Code	Size	Price
80902	n/a	£7.00

Rubi White lens goggles

Field of use: basic. Mechanical resistance to high speed particles, low energy. Extendable in length and vertically adjustable side pieces. Anti-scratch and anti-fog. UV Filter. Comfortable and light. Conforms to EN166 and EN170



ONLY
£6.15
each

Code	Size	Price
80918	n/a	£6.15

Rubi Reinforced gloves

Protective gloves against mechanical risks. High resistance to abrasion and tearing. Protection level: 4132 Conforms to EN338



ONLY
£2.50
each

Code	Size	Price
80906	10	£2.50

Rubi Latex gloves

Ideal for wet or abrasives tasks. For minimal risks only. Made of 100% latex. Conforms to EN420.



ONLY
£1.50
each

Code	Size	Price
20907	one size	£1.50

Rubi Set of smooth soles.

Increases contact by 100% approx.



ONLY
£24
each

Code	Size	Price
5985	n/a	£24.00

Washable/reusable face masks



ONLY
£1.92
each

Code	Size	Price
H1172507	Black	£1.92

Surgical Masks 3-Ply



ONLY
£5.96
box of 50

Code	box of	Price
H1172509	50	£5.96

Hand Sanitiser Pump Dispenser



ONLY
£3.52
each

Code	Size	Price
H1172524	500ml	£3.52

Hand Sanitiser and Pump Dispenser



ONLY
£25.20
each

Code	Size	Price
H1172526	5ltr	£25.20
H1172527	Pump	£5.96

Aerosol Sanitiser Disinfectant Spray 500ml



ONLY
£6.50
each

Code	Size	Price
H1172535	500ml	£6.50

Healgen Covid-19 Lateral Flow Test Kits

UK Government Approved COVID-19 test

20 tests per pack
Simple to use
Test results in 15 minutes
UK Government approved
Help to keep essential work up and running
97% effective



ONLY
£175
each

Code	Size	Price
H1172550	20 tests	£175

Power Tools

for the Trade

Only
£389

each
H9307000

FLEX

Flex MXE 18.0-EC Cordless 18v Brushless Mixer Kit With 3-Level Speed Switch, 2 X 5.0ah Batteries & Charger



Flex MXE Cordless Paddle Mixer Kit

Flex MXE 18.0-EC Cordless 18v Brushless Mixer Kit With 3-Level Speed Switch, 2 X 5.0ah Batteries & Charger



ONLY
£389
each

Code	Volt	Price
H9307000	18	£389

Sparky Angle Grinder 115mm

SPKM750 Angle Grinder. 750W motor, ideal for use with diamond cutting blades and hole saws



ONLY
£45
each



Code	Volt	Price
H1199205	240	£45
H1199206	110	£45

Sparky Wet & Dry Vacuum With Power Take-Off

SPKVC1431 Powerful 1400W wet and dry vacuum.
30 ltr capacity plus power take off for power tools.



ONLY
£106.50
each

Code	Volt	Price
H1199240	240	£106.50
H1199241	110	£106.50

Sparky Diamond Core Drill Kit C/W 3 Bits *

SPKBBK1100E Diamond Core Drill Kit with 1100W drill, 3 diamond core bits and case. Ideal for drilling larger holes through masonry



ONLY
£187.50
each

Code	Volt	Price
H1199250	240	£187.50
H1199251	110	£187.50

Sparky Heavy Duty Paddle Mixer

SPKBM21060CE/CL Paddle Mixer with 1050W motor and 2 speeds for controlled mixing.
Complete with M14 connection, and 2 paddles



ONLY
£219
each

Code	Volt	Price
H1199230	240	£219
H1199231	110	£219

Sparky Breaker/Scraper SDS+ C/W 2 Bits & Case

SPKK306E Versatile power tool. Can be used with the chisel point for breaking through masonry or with the scraper bit for rapid removal of tiles. 650 W motor c/w 2 chisel bits and case



ONLY
£168
each

Code	Volt	Price
H1199256	240	£168
H1199231	110	£168

Rubi AS-30 PRO Vacuum Cleaner

The AS-30 PRO vacuum cleaner by RUBI is perfect for suction work with both solid particles (dust and cutting waste) and liquids.

Socket for electric tool (max.2000W). 1400W motor.
Includes 4m electric cable. Accessories included are Hose, nozzle (35/37 mm.)and crevice tool, Steel pipes, Wet brush, Filter damp sponge for wet, HEPA filter for dry. 30ltr capacity



ONLY
£137
each

Code	Volt	Price
50962	240	£137

Rubi AS-30 PRO Vacuum Cleaner Dry Filter

HEPA filter for dry vacuuming with AS-30 PRO



ONLY
£11
each

Code	min particle size µm	Price
50998	5	£11

Rubi AS-30 PRO Vacuum Cleaner Wet Filter.

Filter for wet vacuuming with AS-30 PRO.



ONLY
£8
each

Code	pack	Price
50999	2	£8

Rubi AS-30 PRO Vacuum Cleaner Paper Bag.

Biodegradable paper bag for dust vacuuming with AS-30 PRO.



ONLY
£13
each

Code	pack	Price
50964	4	£13

Rubi Bucket for RUBIMIX-50-N

Rubber Bucket 65 l. Spare RUBIMIX-50-N and also for use with RUBIMIX-9/9 PLUS and 9 DUPLEX.



ONLY
£15.95
each

Code	Price
60202	£15.95

Rubi Bucket for RUBIMIX-25-N

Rubber Bucket 40 l. Spare RUBIMIX-25-N and also for use with RUBIMIX-9/9 PLUS and 9 DUPLEX..



ONLY
£10.73
each

Code	Price
60265	£10.73

Rubi FAST-IN adapter

Adapter for use of the FAST-IN mixer paddles. Transforms threaded connection M14x2 to quick connection system FAST-IN. Adaptable to any mixer with M14x2 thread.



ONLY
£9.60
each

Code	Price
76907	£9.60



Rubi Mortar mixer paddle FAST-IN FI 3H

Helix head with 3 paddles for better mixing. Fast connection without tools FAST-IN. Compatible with RUBIMIX-16 ErgoMax or FAST-IN (Ref. 76907) Adaptable to any mixer with M14x2

FROM
£12.90
each



Code	mm	Price
76941	100 x 550	£12.90
76942	120 x 600	£16.80
76943	140 x 600	£20.20

Rubi Liquid mixer paddle L-FI

For mixing liquids and low density materials. Fast connection without tools FAST-IN. Use only RUBIMIX-16 ErgoMax or FAST-IN adapter (Ref. 76907).

FROM
£13
each



Code	mm	Price
76904	100 x 550	£13
76905	120 x 600	£17

Rubi Chuck

Chuck attachable to RUBIMIX-9, 9 PLUS and RUBIMIX 16 Ergomax to work with hexagonal and round finishing rods below 12mm. Includes chuck key - S2 Ref. 71969.

FROM
£3
each



Code	Price
71967	£11
71969	Key £3

Rubi Mortar mixer paddle M-R 3H

Helix head with 3 blades for higher efficient mixing. M14 x 2 thread connection. Adaptable directly to RUBIMIX-9/9 PLUS and other brands.

FROM
£15
each



Code	mm	Price
76917	100 x 550	£15
76918	120 x 600	£19
76919	140 x 600	£23
76940	160 x 600	£30

Rubi Epoxy mixer paddle E-80

Special mixing between 2.2 - 4.4 Lb. (1 - 2 kg.) of epoxy resins. 8 mm. hexagonal finish. Adaptable to RUBIMIX-9/9 PLUS by chuck (Ref. 71967).

ONLY
£14
each



Code	mm	Price
65939	80 x 400	£14

Rubi Standard mixer paddle ML

To mix all materials. 10 mm. hexagonal finish. Adaptable to RUBIMIX-9/9 PLUS by chuck (Ref. 71967).

ONLY
£12
each



Code	mm	Price
65931	100 x 520	£12

Rubi Liquid mixer paddle L

To mix liquid and low density materials.

ONLY
£13.54
each



Code	mm	Price
65933	80 x 400	£13.54
Adaptable to RUBIMIX-9/9 PLUS by chuck (Ref. 71967).		
65934	100 x 550	£15.09

Rubi Plaster mixer paddle P-R

For mixing between 33.1 - 66.1 Lb. (15 - 25 kg.) of plaster. M14 x 2 thread connection. Adaptable directly RUBIMIX-9/9 PLUS and other brands.

ONLY
£15.13
each



Code	mm	Price
72954	120 x 600	£15.13

Rubi RUBILIM-50-NDS 230V/50-60Hz

Cleans, polishes, brightens, grout, crystallizes, and waxing by changing the accessory. 2 HP single phase motor3 working speeds: 60, 120, 180 r.p.m.IP54. Handles high strength aluminium with rubber coating. With instant soft start and stop, maintains a large performance cleaning, polishing floors and crystallized. Handlebar locking system.

Rubber wheels placed in external position for stability. Band incorporates neutral color bumpers to avoid staining the walls. Electric cord; 33 ft. (10 m.). Includes Polypropylene brush (Ref. 60970) and liquid tank of 2.9 gl. (13 l.).

ONLY
£1,650
each

Code	mm	Price
62969	2	£1,650.00



Rubi Rubimix E-10 Energy

18V 5AH Cordless mixer with 2 speed gearbox, progressive switch and safety lock. Includes Mixer, battery charger, 1 battery and M120F1 mixing paddle Battery Energy 18V 5AH

ONLY
£86
each



Code	capacity kgm	Price
26965	18	£270
26966	Battery	£86

Rubi RUBIMIX-16 ERGOMAX

Handheld mixer for cementitious adhesives, resins, paints and other materials. Gearbox with 2 speeds (1st 0-430 rpm / 2nd 0-570 rpm). Progressive switch (R.P.M. regulation). Ø maximum of mixer 160 mm. Mixer paddle Ø 140 mm. FAST-IN (5 9/16 ") included. Thread Direct link for mixers with M14 finish. Weight: 4.6 kg. Electrical cable: 3 m

FROM
£149
each



	Code	capacity kgm	Price
110V-50/60Hz UK	24995	1600	£149
230V-50/60Hz UK	24996	1600	£149
230V-50/60Hz UK W/CASE	24998	1600	£170

Rubi RUBIMIX-9 N

Handheld mixer for cementitious adhesives, resins, paints and other materials. Direct connection M14 thread. Electronic regulator (1st 0-650 r.p.m. / 2nd 0-850 r.p.m.). Ø maximum paddle:140 mm. Ø 120 mm mixing paddle included..

ONLY
£107
each



Code	Power W	Price
RUBIMIX-9 N 110-130V 50-60 Hz. UK	25942 1200	£107
RUBIMIX-9 N 210-240V 50-60 Hz. UK	25944 1200	£109
RUBIMIX-9 N 210-240V 50-60 Hz. + chuck + portabrocas	24986 1200	£130
RUBIMIX-9 N 210-240V 50-60 Hz. + case	24958 1200	£135

Rubi RUBIMIX-9 DUPLEX 230V 50/60HZy

Handheld mixer for cementitious adhesives and other materials. 1 Speed and electronic regulator: 0-480 r.p.m. Ø maximum paddle: 120 mm. x 2. Mixers paddles of Ø 120mm included.

ONLY
£141
each



Code	Power W	Price
25943	1350	£141



- Fast setting
- Polymer Modified
- Flexible

Quickflex

tile adhesive for tiling professionals...

Ceramic, porcelain and natural stone interior and exterior tile adhesive





Over Sixty Years of Innovation & Still Evolving..

N&C Nicobond are British manufacturers and distributors of high quality tile adhesives, grouts, smoothing compounds and tiling systems. We have further developed our highly reputable powder range of adhesives making use of new innovative raw material technologies, which offer the professional tiling contractor exceptional handling characteristics alongside market leading levels of strength and flexibility. Every product within the range has been formulated & rigorously tested to exceed all the relevant British and European Standards.



Experience | Proven Pedigree | Reliable | Confidence | Quality | Tested | Competitive | Service | Performance



N&C

Nicholls & Clarke Group

N&C Building Products Ltd.
Registration Number: 140
Registered in England
www.nichollsandclarke.com
Code Y50096



JOIN US VISIT US PHONE US FAX US EMAIL US

www.nichollsandclarke.com

info@ncnicobond.com

Distribution Centres, Trade Counters and Showrooms

N&C Building Materials
41-51 Freshwater Road
Chadwell Heath
Romford, Essex RM8 1SP
Tel: 020 8586 4600
Fax: 020 0586 4646

Unit 4
Cothill Close
Plympton
Plymouth PL7 1SR
Tel: 01752 339724
Fax: 01752 342746

Units 3 & 4
Cardiff Trade Park
Hadfield Road
Cardiff CF11 8AQ
Tel: 029 2039 0146
Fax: 029 2022 4356

Unit 4
Waterloo Industrial Estate
Flanders Road, Hedge End
Southampton SO30 2QT
Tel: 01489 779700
Fax: 01489 779701

Nicholls & Clarke

Est 1875

Trade Counters and Showrooms

Units 1A/B Alexander Place
Lower Park Road
New Southgate
London N111QD
Tel: 020 8361 6050
Fax: 020 8361 4757

Unit 8 Ascent Park
Edinburgh Way
Harlow Essex CM20 2HW
Tel: 01279 621980
Fax: 01279 621981

Unit 9 - 11
McDonald Business Park
Maylands Avenue,
Hemel Hempstead
Hertfordshire HP2 7EB
Tel: 01442 234635
Fax: 01442 279501

25 Gunnels Wood Park
Gunnels Wood Road
Stevenage Hertfordshire SG1 2BH
Tel: 01438 315400
Fax: 01438 740338

Unit 14 Meridian Trading Estate
Bugsby Way
Charlton London SE7 7SJ
Tel: 020 8269 5960
Fax: 020 8269 5961

Unit 1 Cliffside Trade Park
Motherwell Way
Lakeside West Thurrock
Essex RM20 3XD
Tel: 01708 680180
Fax: 01708 680181

Unit 8D Pompey Centre
Fratton Way Southsea
Portsmouth PO4 8TA
Tel: 02392 894599
Fax: 02392 894598

Unit E5
Copley Hill Trading Estate
Whitehall Road, **Leeds** LS12 1HE
Tel: 0113 243 5644

Units 10, 11, 14 & 15
Advent Business Park
Advent Way
Edmonton N18 3AF
Tel: 020 8807 3227
Fax: 020 8807 3223

2 - 3 Allbarn Close
Wyncolls Road
Severalls Park
Colchester Essex CO4 9HY
Tel: 01206 849300
Fax: 01206 845878

Unit 5 Tower Court,
St. David's Road
Swansea Enterprise Park
Swansea SA6 8AL
Tel: 01792 797337
Fax: 01792 774019

Leofric House, Off Phoenix Way
Waterman Road, **Coventry** CV6 5TP
Tel: 02476 705300
Fax: 02476 705301

1 Frensham Road
Sweetbriar Industrial Estate
Norwich Norfolk NR3 2BT
Tel: 01603 409169

*Customers are invited to request a full copy of our terms and conditions of trade before they purchase goods from the Nicholls & Clarke Group. Every effort has been made to ensure the accuracy of the information given in this booklet. The Nicholls & Clarke Group reserves the right to change specifications and availability without prior notice. The colours shown within this booklet are as the limitations of the printing process will allow. All prices correct at time of going to print and we reserve the right to amend any price shown. Price will be deemed correct at time of despatch.