

N&C

Synergy  
Series





The Nicholls & Clarke Group is a business dedicated to the manufacture and supply of the finest building materials. Founded in 1875 in London, we have grown from servicing the capitals' building trades to becoming the largest privately owned national manufacturer and distributor of fine quality building products.

Quality manufacturing is at the core of our business and comes as standard. We own state of the art manufacturing facilities based across the UK and Central Europe. This gives us the broadest manufacturing capability available, allowing us to offer an extensive portfolio of product, more specialised than that of any of our competitors.

Our distribution network is supported with our private fleet of over 110 commercial vehicles. This gives us full logistical control from the point of manufacture through to delivery to site. We offer a nationwide delivery service, be that to site, home or commercial address. The vast majority of our deliveries are made on a next day basis.

## Create seamless spaces with Synergy

The Synergy Series makes it easy for the designer, housebuilder or home owner to use a mix of materials, colours and elements such as ceramics, porcelain, woods, glass, paints, bathroom products and furniture throughout their project with the confidence that each room can have a change of colour, trend and style, but where all components will work beautifully together in harmony with colours and tones that complement each other perfectly.

We have developed the award winning Synergy series to meet new, future trends that adhere to the tastes and direction of fashion and interiors, whilst keeping true to the successful, well adopted Synergy Series that combines on-trend materials, shapes, tones and elements to create the perfect interior throughout the home, commercial space and outdoor environments.

The range combines woods, porcelain, ceramic, mosaic, glass, paints, grouts, sealants, shower trays and furniture in co-ordinating hues and tones, available in different sizes and textures in order to create an enhanced effect greater than that of their individual appeal. We have collaborated with Dulux and Sicis, brand leaders within their product areas to strengthen the portfolio and help create even more beautiful spaces through Synergy.

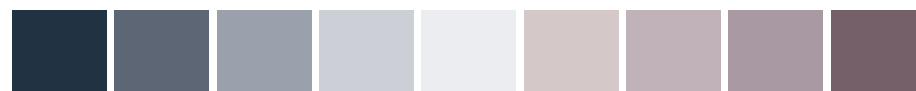



# Synergy

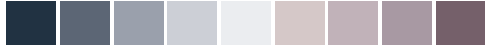

## Our Customers

As a multi-faceted company with a reputation and pedigree built over 140 years, we have gained a depth of knowledge and invaluable experience in the supply and distribution of N&C products. We have experience across many industries with a huge portfolio of products suited to all project environments. We work with and supply to the design industry, housebuilders, contractors, retailers and end users.

## Research & Development

The product and design teams are constantly engaged in research and development to ensure that the new collections meet future trends, market requirements, as well as new innovations that make us unique suppliers. Investment in the latest laboratory equipment and testing facilities allow us to push forward with the development of the next new technology or raw material that will further enhance product performance or characteristics. Prior to going to market, we undergo rigorous testing of all our products to ensure that performance is to a high standard. All products are tested to meet the relevant standards and regulations.

## High Definition Imaging

Our factories use the latest in inkjet technology with high precision processes to closely replicate the natural beauty of woods, stones and other effects on ceramics and porcelains. The result is an outstanding replication of the real material.



## Total Solution Providers

As part of the Nicholls & Clarke Group, we have the ability to offer the complete package through a comprehensive range of quality products. You can benefit from dealing with one source, making it easier to co-ordinate project supplies. Furthermore, with nationwide distribution depots, we hold over £10,000,000 worth of stock for immediate collections or next day delivery (subject to delivery schedule).

## Inventors & Innovators

We embrace new technologies within the industry which help to better define our portfolio, with products that perform, where quality and functionality are at its peak. As inventors, we continue to engage in research and development. Our factories use the latest in inkjet technology and manufacturing processes for the optimum in quality and design.

## 24 Hour Nationwide Delivery

We are unique in being able to offer nationwide, next day delivery (subject to delivery schedule), even when you order up to 5pm the day before and there is no minimum order requirement. N&C operates from 18 branches nationwide, so can offer localised delivery. With thousands of product lines in stock, you also have the option to collect.

## British Manufacture

Our three state of the art U.K manufacturing facilities comply with ISO9001 and ISO14001. They utilise the latest manufacturing technologies and apply stringent quality control checks during every part of the manufacturing process. Only the highest quality raw materials, product formulations and packaging materials are used, ensuring the finished product meets our exacting standards, far exceeding those of the latest European standards.

## Customer Care

We aim to provide you with an outstanding level of customer service that will help to further enhance the service you offer to your clients. We monitor our performance levels and strive to achieve 100% client satisfaction. We believe that open channels of communication with our customers, coupled with their feedback are a sure way of further improving our customers buying experience.

## Technical Service

Our Technical Team has well over 200 years of combined experience in the tile industry. We are able to offer a full technical specification service and are available to attend any site address throughout the U.K. A technical written specification is available on request.

## Trade Associations & Technical Committees

N&C are heavily involved in the creation of British & European Standards for decades. We have chaired The Tile Association (TTA) and their Wetroom Technical Committee. We continue to push for stringent policing of the industry which would stop manufacturers falsely claiming specific European standards on packaging. Our philosophy has always been to drive up quality and standards whilst remaining highly competitive.



## Collaborations

We have collaborated with a number of brand leaders within our newly developed Synergy Series by working with companies that lead and specialise within the market for that product area. We have collaborated with Dulux, the leading UK paint brand on the future colours that form part of Synergy Paints. We have also collaborated with Sicis, specialists and international leaders in mosaics.





## Ceramic

With a glazed finish on the front and a clay "biscuit" backing, ceramic tiles are available in many colours and sizes, in a variety of finishes such as gloss, satin or matt. The high porosity biscuit allows the use of ready-mixed adhesives. Being easier to cut and install than porcelain or natural stone often makes ceramics a more cost-effective option. The use of inkjet printing technology in some ranges adds a natural appearance. Some ceramic tiles can be used on the floor. Due to the manufacturing and firing process, ceramic tiles may vary in tone or size between batches and therefore it is important to ensure that all boxes are marked with the same batch number and tiles from a number of boxes are mixed during fixing. Please ask in branch for details.

## Porcelain

The higher firing temperature of porcelain tiles ensures that they are fully vitrified, producing tiles with enhanced properties which are harder wearing, with increased load ratings and the manufacturing process of unglazed or through bodied porcelain means that if the tile suffers an impact chip, the original colour remains. As with ceramic tiles, the manufacturing and firing process may produce a variance in tone or size between batches and therefore it is important to ensure that all boxes are marked with the same batch number and tiles from a number of boxes are mixed during fixing. Please ask in branch for details.

## Natural Stone

Travertine, marble, slate and limestone ranges are natural products quarried from around the world. These tiles are produced from naturally occurring stone and therefore the colour and patterning may vary quite considerably between tiles – this is a feature of this kind of product. All natural stones require specific treatment while fixing, including initial cleaning, impregnator sealing and on-going maintenance. It is important all relevant instructions are followed.

## Mosaics

The majority of our mosaic tiles are attached to a mesh backing for ease of installation. The mesh can be cut to size with scissors to provide a cost-effective border or décor strip with any main tile.

## Terrazzo

In a typical manufacturing process, graded marble or quartz is compressed and blended together with a resin producing an amazing finish. Large blocks are produced which are cut to size and given the required surface finish. Specific fixing instructions must be followed with this material.



## Colour Shade Variation Grading

The variation of colour, texture, and tone between individual ceramic tiles is referred to as 'colour shade variation'. Variation in colour and shade is an inherent characteristic of any fired product and can actually enhance the character and beauty of the project. Shade variation is inherent in all tile products, including man-made tiles. Shade texture will vary from piece to piece within production runs.

V1 shade variation has little or no change from piece to piece, whereas a V4 will have a large variety of colour and/or texture changes. Prior to any installation, the tiles should be approved by the customer as shades of colour are seen differently on computer screens and brochures. Therefore, we advise that customers request a sample before making a final selection or purchase.



V1

### V1-Uniform Appearance:

Minimal to no difference among pieces from the same production run because each ceramic tile is manufactured using the same glaze applications and body texture.



V2

### V2-Slight Variation:

Distinguishable differences in texture and/or pattern within similar colours.



V3

### V3-Moderate Variation:

Though the colours present in a single piece of ceramic tile may indicate the colours to be expected on other tiles, the amount of colours on each piece may vary significantly.



V4

### V4-Substantial variation:

Random colour variation from tile to tile, so that one ceramic tile may have a totally different colour from that on other tiles. Thus, the final installation will be unique.



# Synergy



At N&C we engage in colour forecasting and anticipate future colour trends relevant to consumer tastes, as well as commercial environments. Our colour palette has been influenced by bringing together the insight and knowledge of leading colour specialists.

Developing on the pre-existing palette of Synergy colours, we have slightly evolved the colour selection to adhere to future tastes. Our collaboration with leading colour specialists, Dulux and international leaders in mosaics, Sicis, has helped to secure the existing palette.

## THE COLOUR TEMPERATURE SCALE

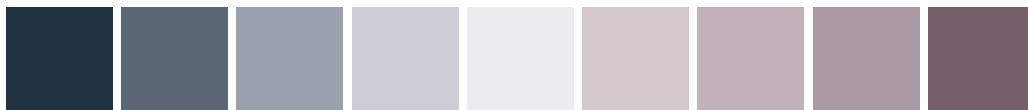

By selecting the right colour scheme, you can achieve the desired outcome for your project. Colour can be your most powerful design element if you use it effectively.

The colour palette offered within the Synergy Series is divided into warm and cool colours. This approach enables you to categorise the tones within the palette in order to achieve your desired scheme.

Warm colours are inviting and trigger a sense of comfort, whereas cool colours can give an impression of serenity, contemporary living or elegance. 'Greige' is a term used to define a colour that uses a balance of grey with a warm undertone to combine elements of both. Bold accent colours added to the Synergy theme helps to create personality individuality in the design.

## ANALOGOUS COLOUR SCHEME

Synergy uses a fairly simple colour concept. We use an analogous colour scheme, whereby the colours are next to each other in the colour spectrum rather than contrasting.

## TONES, TINTS AND SHADES

The Synergy Series uses different tones, tints and shades. If a colour is made lighter by adding white, the result is called a tint. If black is added, the darker version is called a shade. If grey is added, the result is a different tone. They complement each other very well and create serene and comfortable designs. These colour schemes are often found in nature and are harmonious and pleasing to the eye.





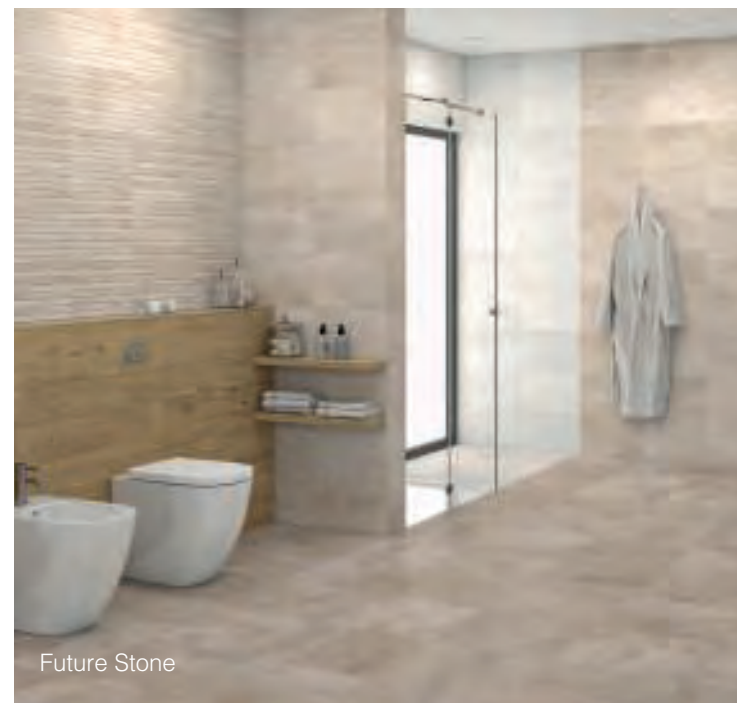

Future Stone



Castello





## Indoor / Outdoor Tiles

Use Synergy to increase the perceived size of your living space or commercial area with our collection of indoor/outdoor tiles. Seamlessly extend your inside flooring to a balcony or patio area. Outdoor tiles have a pendulum test value of >36 which means they are suitable for outdoor use.

**Dulux**  
Paints

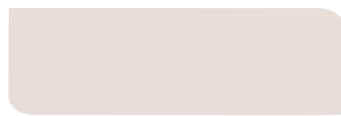

Synergy C Paper Chain



Synergy L



Floors

Use our 'Surface' porcelain 600 x 600mm floor tile in 'light graphite' to achieve this on trend look



Grouts

Create the ultimate seamless interior with a co-ordinating grout such as Nicobond Starlike Silver Grey



Surface

*Extend your living spaces outdoors...*



Synergy

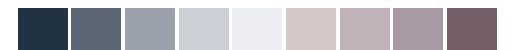





Wood Direction

*Welcome the beauty of nature inside...*

---





## Wood Effect Tiles

Wooden floors are a sought after look for many people. Tile manufacturing uses the latest in inkjet technology to produce close replications of real wood onto porcelains and ceramics. Tile replications give the flexibility of achieving a variety of colours and using different wood types. It also enables us to capture the intricate detailing of real wood whilst maintaining the durability, strength and ease of maintenance of a tiled floor.

**Dulux**

Paints

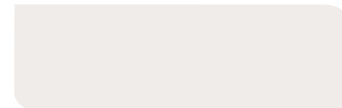

Synergy I

Grey Steel 4



Floors

Opt for Wood Direction, which enables you to create a dramatic, varied look that is on-trend with a smaller format planks effect or Wood Living, for a more standard wooden floor look!



Grouts

Use Nicobond Starlike white grout for defined lines, or Nicobond Starlike Light Coffee for a seamless appearance

# Synergy

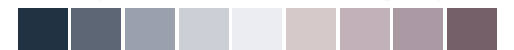



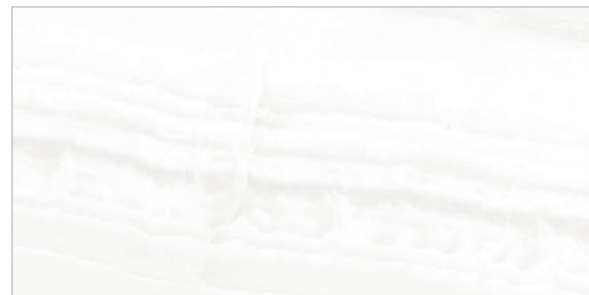
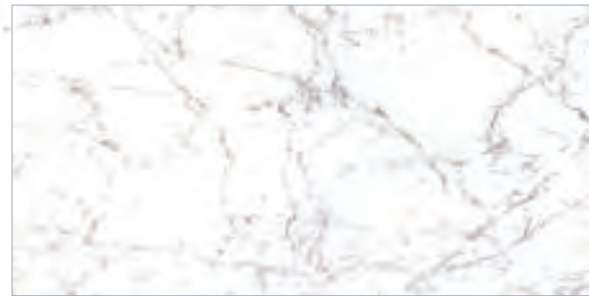

## Natural Stone Effect Tiles

The beauty of natural stone is its varied nature formed sometimes over millions of years. The differences in colour, shading, veining and sometimes texture will give you the most beautiful wall & floor coverings that will always look as nature intended. Invite the beauty of natural stone into your home with our collection of natural stone effect tiles. Marble is the look of the moment with ranges that offers a twist from historic luxury to modern sophistication.



Walls

Marbellous is our comprehensive range that utilises the beauty of marble in a 300x600 and 250x550mm size format, and irregular square mosaic



Floors

Create a slip resistant surface with our Amani Grey irregular square mosaic to create a contrast on the floor. Couple with 330x330mm floor tile of the same colour for a co-ordinated look



Grouts

Use Nicobond Starlike in Slate to create a striking effect, or in White to create a seamless tiled wall and floor

*Make a statement in your home or commercial space...*



Marbellous

# Synergy

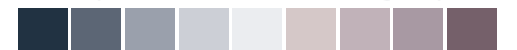



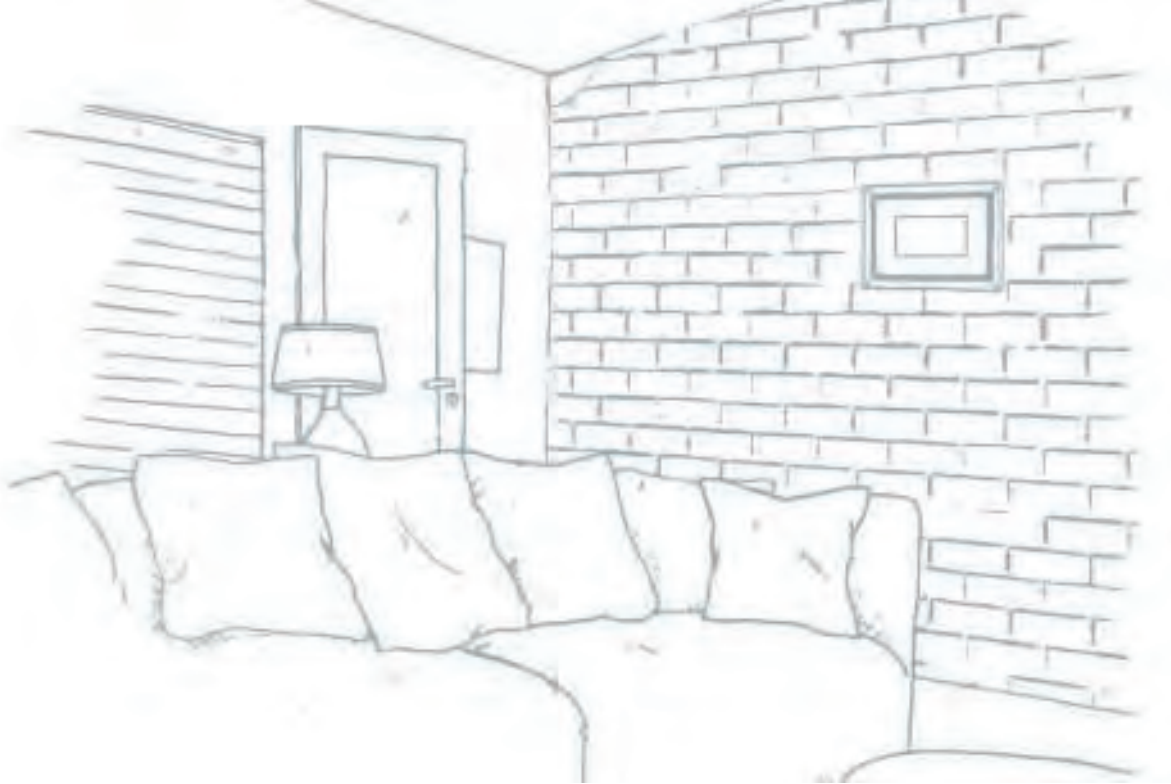

## Feature walls

Incorporate a focal point in your home or commercial environment by adding a feature wall. A tiled feature wall helps to add dimension and character to the room. Create either a contrasting, striking design using décor tiles, such as mosaics or add a tonally similar colour with texture. Opt for Split Face, a range set on three levels to add dimension and imitate what nature has to naturally offer.

**Dulux**  
Paints



Synergy D      Roasted Bracken 4



Walls

Split Face Cream on the wall creates a striking feature wall within the room



Floors

Wood Direction Camel offers a gorgeous wooden floor effect



Grouts

Use Flexible Grout Plus in Light Coffee to achieve the look

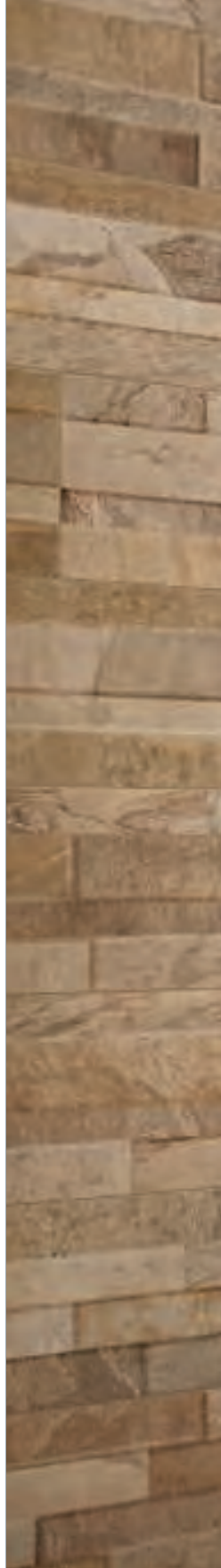

*Bring out your style with a feature wall...*





Slipface

# Synergy







Bevels Black



Time Black Anti-Slip



Diamond Surat



Metallica Black Mosaic



Landscape Black



Wood Living Grey



Wood Grove Blue



Time Silver Polished



Affinity Cool Silver Grey  
Brushed Floor

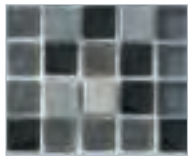

Clarity Black/Silver



Time Black Natural



Affinity Slate Black  
Brushed Floor



Affinity Slate Black



Time Grey Natural



Cemento Light Grey



Bevels White



Affinity Cool Silver Grey  
Brushed Mosaic



Hexagon White Glass



Time Black Polished

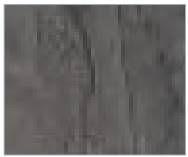

Geology Dark Graphite

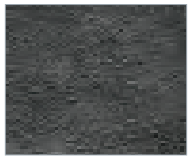

Surface Dark Graphite  
OUT

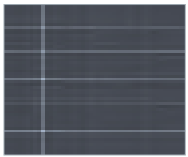

Affinity Slate Black  
Mosaic



Civic Gris Mosaic

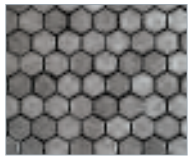

Hexagon Dune Glass



Sky Blue



Marbellous Statuario  
Arabescato



Marbellous Dolomite  
Bianco



Future Stone Black



Surface Dark Graphite IN



Marbellous Orobito  
Silver



Affinity Dark Black Mixed  
Mosaic



Smart Multi Stone  
Dark Grey



Geology Light Graphite

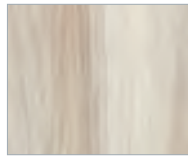

Wood Grove White



Affinity Light Black Mixed



Marbellous Onice Bianco



Affinity Black Brushed

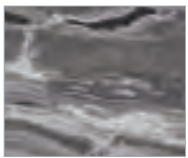

Castello Windsor Black  
Lapato Polished



Time Carbon



Progress Dark Grey IN



Concept Graphite

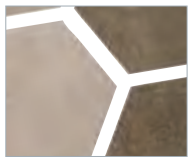

Merge Cool Mix



Wood Stone White



Sky White



Marbellous Statuario  
Arabescato



Metallica Black



Gala Antracite Black



Progress Dark Grey OUT



Bevels Dark Grey



Split Face Slate Black



Surface Light Graphite IN



Castello Balmoral White  
Lapato Polished

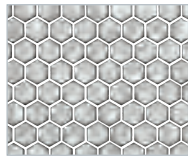

Hexagon Glass Carrara



Marbellous Carrara  
Venatino

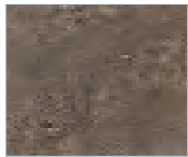

Highland Antracite



Cemento Dark Grey

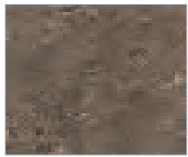

Highland Antracite

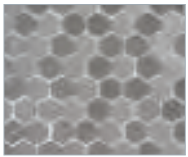

Hexagon Grey Glass



Landscape Mid Grey

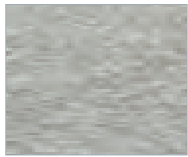

Surface Light Graphite  
OUT



Time Silver Anti-Slip



Whitewood



Affinity Warm White

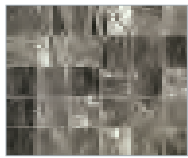

Castello Windsor Black  
Lapato Polished Mosaic



Time Carbon Anti-Slip



Highland Antracite  
Mosaic



Landscape Pearl Grey



Progress Silver Grey



Marbellous Amani Grey



Metallica White

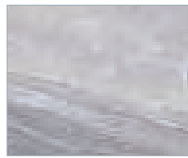

Castello Grey



Surface Warm White IN



Progress Black



Time Carbon Natural



Time Grey Polished



3D Cool Metal/Glass



Time Silver Natural



Bevels Light Grey Gloss



Tracia Grey



Affinity Fresh Jasmine  
Brushed Mosaic

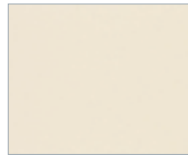

Affinity Jasmine



Concept Hexagon  
Sarenne



Wood Stone Graphite



Geology Light Granite



Wood Grove Green



Cemento Light Grey



Landscape Stone



Future Stone Bone



Surface Warm White  
OUT



Time Snow Anti-Slip

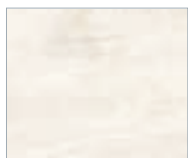

Wood Nature Arara



Future Stone Grey

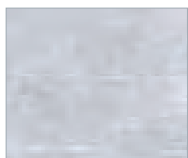

Future Stone Grey

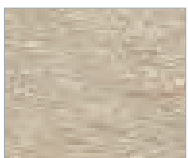

Surface Sand OUT



Wood Direction White

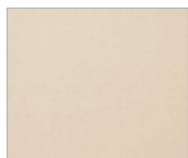

Time Snow Polished



Jewel Bronze



Shift Oro Gold



Linear Glass Bronze

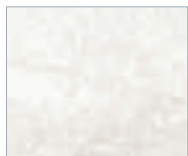

Civic Gris

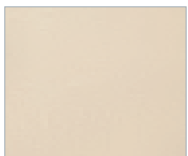

Time Snow

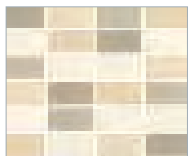

Affinity Coffee Mixed Mosaic



Landscape Clay

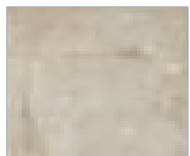

Cemento Warm White

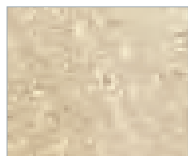

Highland Beige



Time Cream Natural

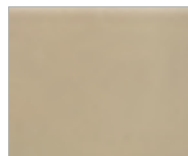

Bevels Coffee



Linear Glass Titanium

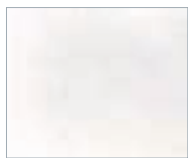

Concept White

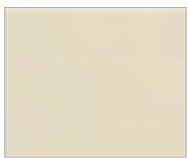

Bevels Bone Cream

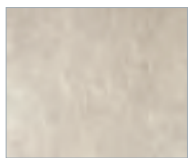

Progress Alabaster



Affinity Cappuccino Mosaic



Buvango Gold Mosaic

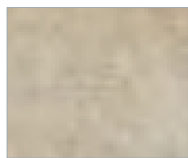

Surface Sand IN

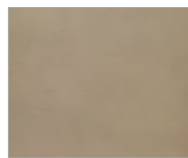

Time Beige Anti-Slip



Merge Warm Mix



Linear Glass Silver

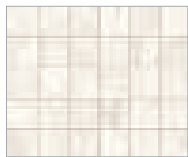

Castello Balmoral White

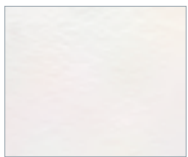

Smart White

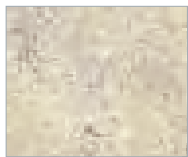

Highland Branco

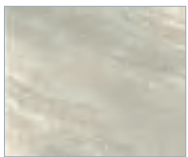

Concept Pearl



Highland Branco Mosaic

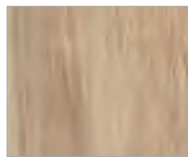

Wood Living Beech



Geology Alabaster



Affinity Light Coffee Mosaic



Shift Antarctica Silver



Bevels Classic Cream

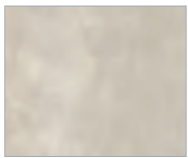

Progress Alabaster



Diamond Excelsior Pearlescent



Progress Stone OUT



Affinity Inviting Cappuccino



Wood Grove Beige



Bevels Almond

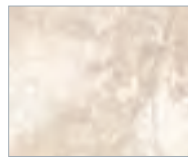

Civic Beige



Smart Bone

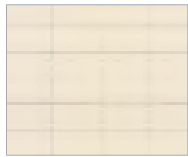

Affinity Fresh Jasmine Mosaic



Time White Polished



Affinity Cappuccino Brushed

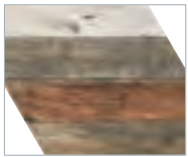

Geology Sand



Affinity Cappuccino Brushed Floor



Wood Direction Camel



Gala Oro

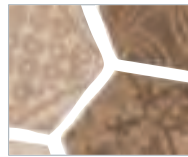

Merge Warm Multi Mix



Diamond Barite



Affinity Fresh Jasmine Brushed



Geology Sand



Cemento Beige



Civic Beige



Time Cream Mosaic



Slit Face Slate Brown



Affinity Coffee



Wood Nature Tuxa



Diamond Fuxian

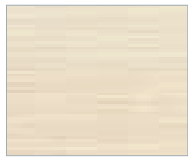

Affinity Fresh Jasmine Brushed

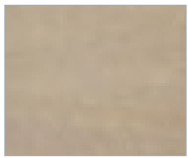

Time Cream Polished



Bevels Almond



Affinity Cappuccino Brushed Mosaic

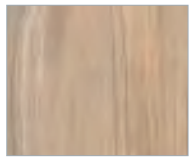

Wood Grove Brown



Time Dove Mosaic



Time Dove Polished



Affinity Coffee Brushed Mosaic



Hexagon Glass Aquamarine



Affinity Cool Silver Grey Brushed



Time Cream Anti-Slip



Smart Multi Stone Bone Brushed



Smart Multi Dune



Tracia Beige



Progress Taupe



Slit Face Slate Multi

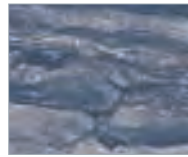

Prague Blue Lapato Polished

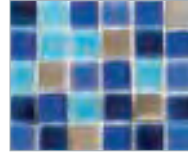

Clarity Cobalt



Geology Alabaster



Progress Stone IN



Time White Natural



Time Beige



Progress Clay



Time Dove



Affinity Coffee Brushed

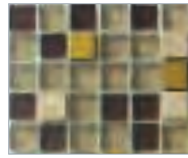

Clarity Cream Marron/Gold

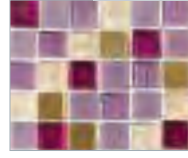

Clarity Berry



# *inspiration through the synergy collection...*

Introducing the world's first collection encompassing 28 unique interior ranges, specially formulated to fuse different elements together and empower you to experiment with a variety of colours, textures, designs, materials, sizes and finishes

PORCELAIN  
 CERAMIC  
 STONE  
 WOOD  
 GLASS  
 WALLPAPER  
 MOSAIC  
 STRUCTURED  
 GLOSS  
 POLISHED  
 ANTI-SLIP  
 WALL  
 FLOOR  
 INTERIOR  
 EXTERIOR  
 PAINT  
 EGGSHELL  
 VINYL MATT  
 SILICONE  
 DECOR  
 FURNITURE  
 SHOWER TRAY  
 LARGE FORMAT  
 HEXAGON  
 RECTIFIED  
 INKJET  
 GROUT  
 TREND

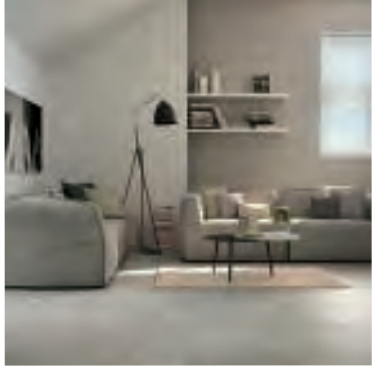
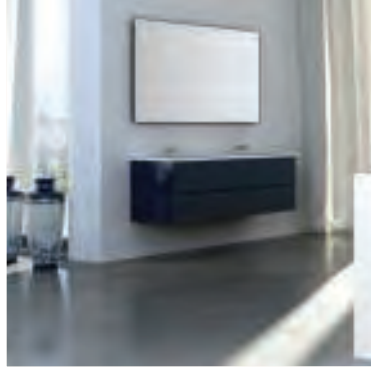
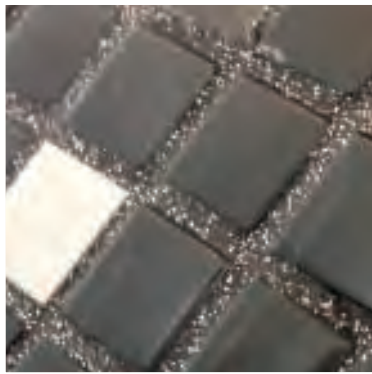







Marbellous











ARGAN  
GEL DOUCHE



# Marbellous

---





Marbellous

---









# Marbellous

Our most comprehensive range, Marbellous utilises the on-trend marble look in a variety of size formats, designs and marble effects without the high cost and high maintenance of real marble. Available in porcelains, ceramics and mosaics, this collection enables flexibility within the home or commercial space.

## Porcelain wall and floor tiles 300 x 600mm



Orobico Silver NB17850



Statuario Arabescator NB17851

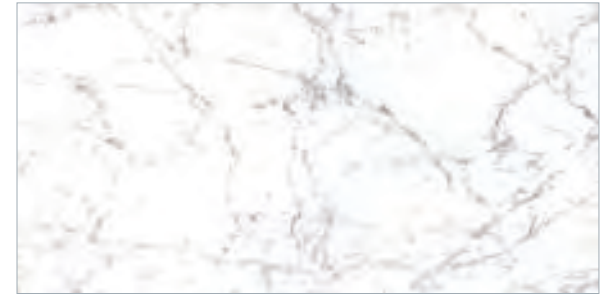

Carrara Venatino NB17852

## Ceramic wall tiles 250 x 550mm



Orobico Silver NB17859



Statuario Arabescato NB17860



Carrara Venatino NB17861

## Porcelain wall and floor tiles 100 x 300mm



Orobico Silver NB17853

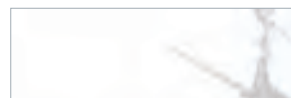

Statuario Arabescato NB17854



Carrara Venatino NB17855

## Porcelain wall and floor tiles 330 x 330mm

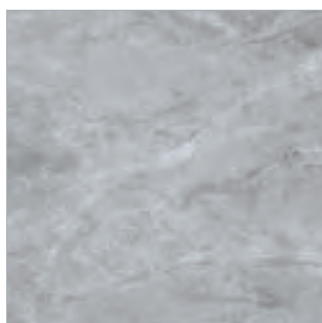

Orobico Silver NB17856



Statuario Arabescato NB17857

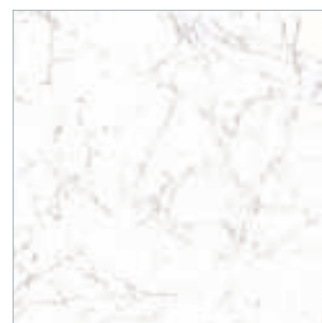

Carrara Venatino NB17858

Porcelain

Ceramic

V4

Structured ceramic wall tiles 250 x 550mm

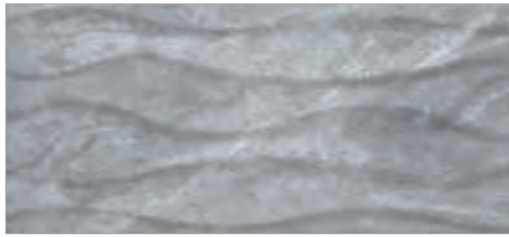

Orobico Silver Structured NB17862



Statuario Arabescato Structured NB17863

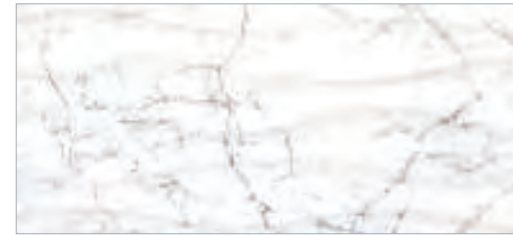

Carrara Venatino Structured NB17864

Porcelain wall and floor tiles 325 x 600mm



Orobico Silver Stick Mosaic NB17874

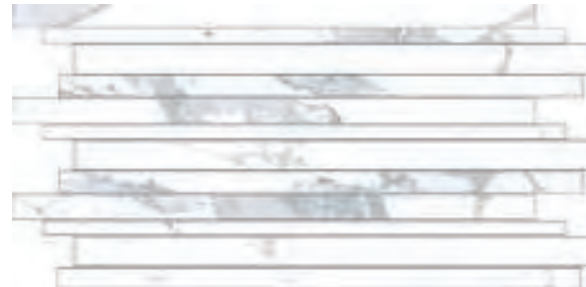

Statuario Arabescato Stick Mosaic NB17875



Carrara Venatino Stick Mosaic NB17876

Porcelain wall and floor tiles 330 x 330mm



Orobico Silver Square Mosaic NB17865

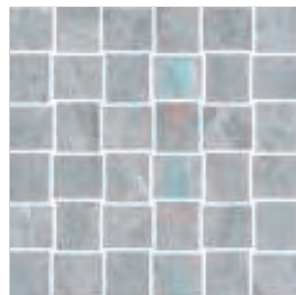

Orobico Silver Irregular Mosaic NB17871



Statuario Arabescato Square Mosaic NB17866



Statuario Arabescato Irregular Mosaic NB17872



Carrara Venatino Square Mosaic NB17867

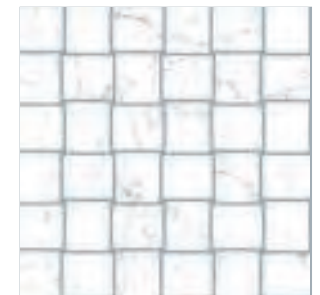

Carrara Venatino Irregular Mosaic NB17873

Porcelain wall and floor tiles 330 x 300mm



Orobico Silver Hexagon NB17868



Statuario Arabescato Hexagon NB17869



Carrara Venatino Hexagon NB17870

Porcelain

Ceramic

V4



# Marbellous

---

## Porcelain wall and floor tiles 300 x 600mm



Dolomite Bianco NB17880

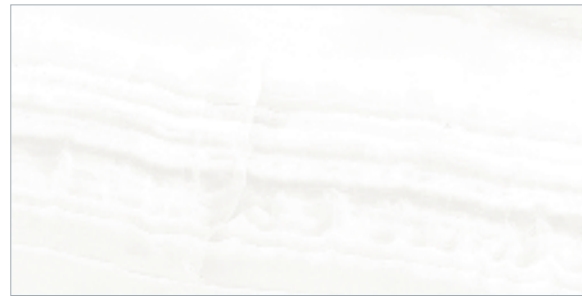

Onice Bianco NB17881



Amani Grey NB17882

## Ceramic wall tiles 250 x 550mm

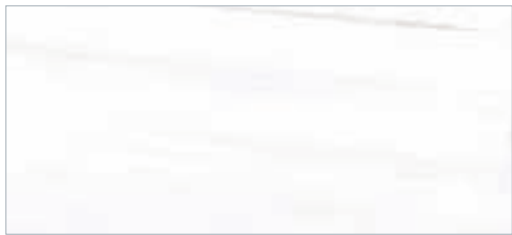

Dolomite Bianco NB17889



Onice Bianco NB17890

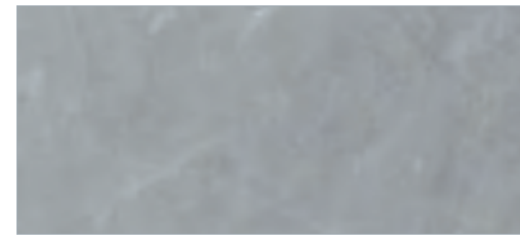

Amani Grey NB17891

## Porcelain wall and floor tiles 100 x 300mm

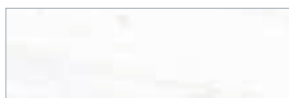

Dolomite Bianco NB17883

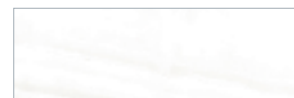

Onice Bianco NB17884



Amani Grey NB17885

## Porcelain wall and floor tiles 330 x 330mm

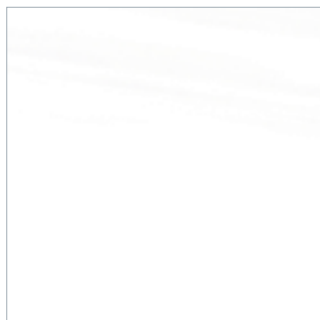

Dolomite Bianco NB17886

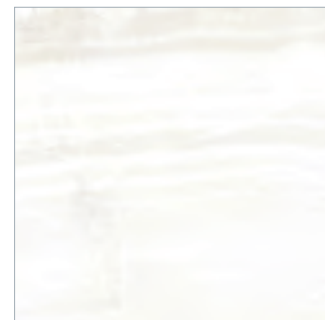

Onice Bianco NB17887



Amani Grey NB17888

Porcelain

Ceramic

V4

Structured ceramic wall tiles 250 x 550mm

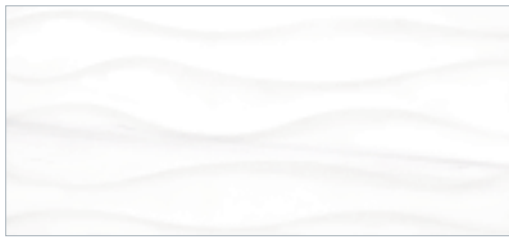

Dolomite Bianco Structured NB17892

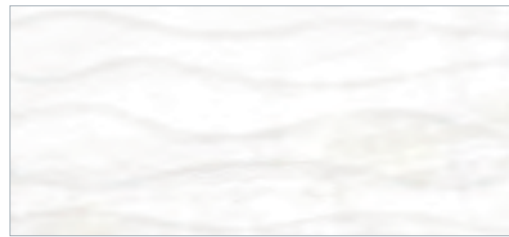

Onice Bianco Structured NB17893



Amani Grey Structured NB17894

Porcelain wall and floor tiles 325 x 600mm

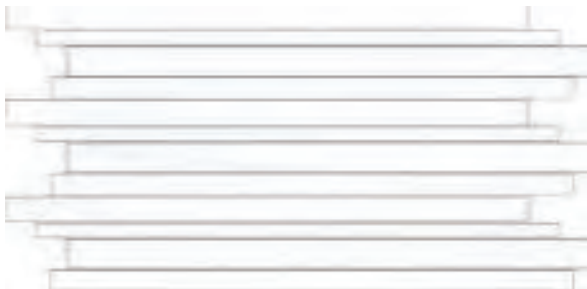

Dolomite Bianco Stick Mosaic NB17904

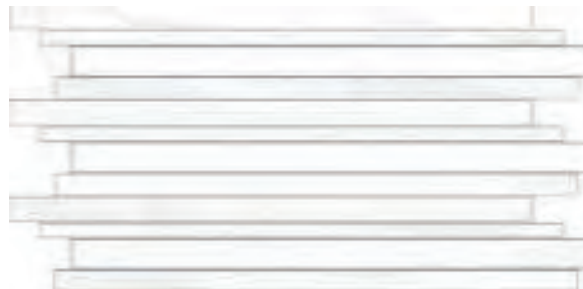

Onice Bianco Stick Mosaic NB17905



Amani Grey Stick Mosaic NB17906

Porcelain wall and floor tiles 330 x 330mm

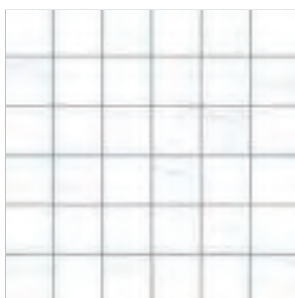

Dolomite Bianco Square Mosaic NB17895

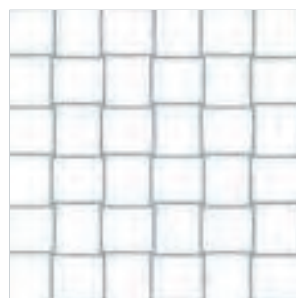

Dolomite Bianco Irregular Mosaic NB17901

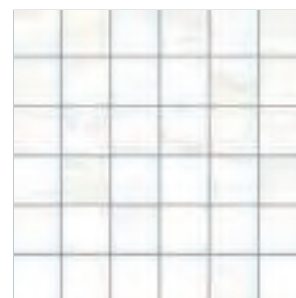

Onice Bianco Square Mosaic NB17896



Onice Bianco Irregular Mosaic NB17902

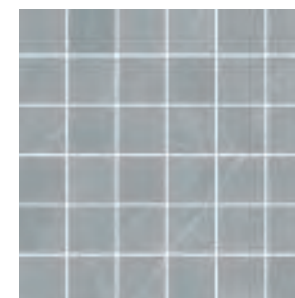

Amani Grey Square Mosaic NB17897

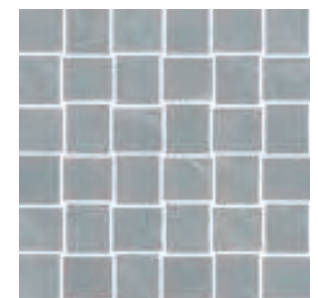

Amani Grey Irregular Mosaic NB17903

Porcelain wall and floor tiles 330 x 300mm



Dolomite Bianco Hexagon NB17898



Onice Bianco Hexagon NB17899

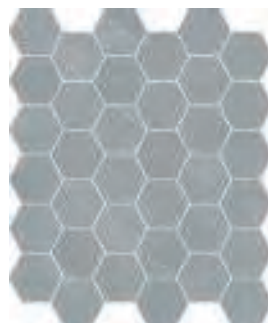

Amani Grey Hexagon NB17900

Porcelain

Ceramic

V4



Highland

---









# Highland

A practical range that incorporates a natural stone look in porcelain that instantly makes it the option for use in high traffic areas or in the home. Combine with a stick mosaic decor for a co-ordinated look.

## Porcelain wall and floor tile 330 x 600mm

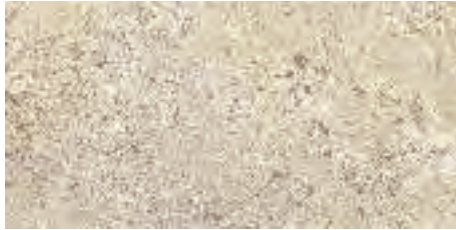

Branco NB18350

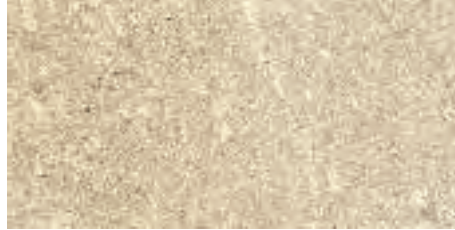

Beige NB18351

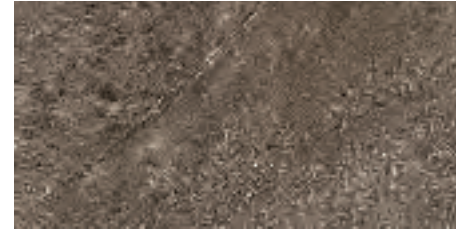

Antracite NB18352

## Porcelain wall and floor tile 600 x 600mm

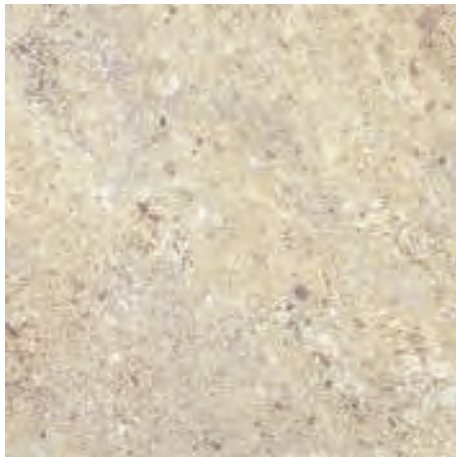

Branco NB18347



Beige NB18348

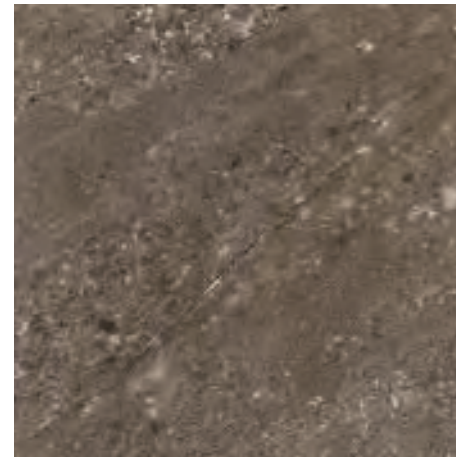

Antracite NB18349

## Porcelain mosaic wall and floor tile 250 x 590mm



Branco NB18353



Beige NB18354



Antracite NB18355









# Bevels

A contemporary take on a traditional style, our bevel edge tile range has been introduced to complement the Synergy palette as an important addition that adds versatility to your design scheme. Opt for a single colour or multi tonal random effect for the perfect backdrop.

## Ceramic gloss wall tiles 200 x 100mm



Black NB1748



Dark Grey NB1737



Light Grey NB1744



White NB1747



Classic Cream NB1746

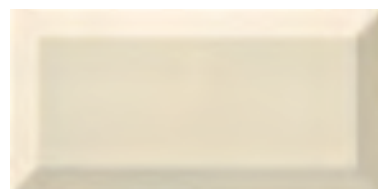

Bone Cream NB1734



Almond NB1735



Coffee NB1736

## Ceramic gloss wall tiles 300 x 100mm



Black NB18181



White NB18180



Bone Cream NB18182



Light Grey NB18183





TODICAL BATH  
TEA TREE ESSENCE  
FOR LATHER  
SILK MARBLE

TODICAL BATH  
TEA TREE ESSENCE  
FOR LATHER  
SILK MARBLE



# Whitewood

Create a distressed look with Whitewood, an on-trend wood effect wall and floor tile range that is the epitome of shabby chic. Perfect for achieving an industrial chic style in the home, a retail environment or art gallery. A dynamic range that has many uses.

Glazed porcelain wall and floor tiles 200 x 1140mm



White NB18090

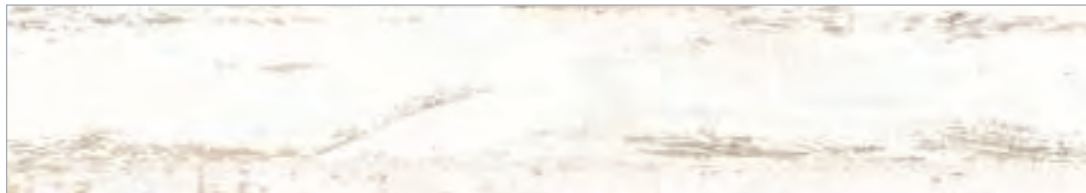



বঙ্গভাষা

bengali







Affinity











# Affinity

Re-invigorate your living spaces with Affinity, a versatile collection of tiles that work perfectly together to create a harmonious, neutral setting. Available in brushed, brushed scored, brushed mosaic and plain alternatives, with a matching floor tile, Affinity is the easy choice across industries.

With a luxurious satin finish, Affinity can be fused together to create a bespoke designer look.

## Brushed ceramic wall tiles 270 x 420mm



Black  
Brushed NB1882



Silver Grey  
Brushed NB1862



Jasmine  
Brushed NB1802



Cappuccino Brushed  
NB1822



Coffee  
Brushed NB1842



Black  
Brushed Scored NB1883



Silver Grey  
Brushed Scored NB1863



Jasmine  
Brushed Scored NB1803



Cappuccino  
Brushed Scored NB1823



Coffee  
Brushed Scored NB1843

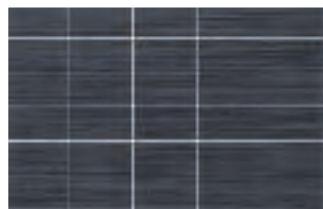

Black  
Brushed Mosaic NB1884



Silver Grey  
Brushed Mosaic NB1864



Jasmine  
Brushed Mosaic NB1804

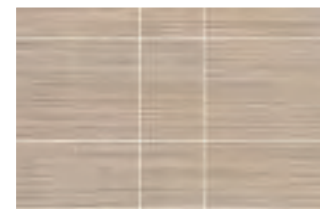

Cappuccino  
Brushed Mosaic NB1824

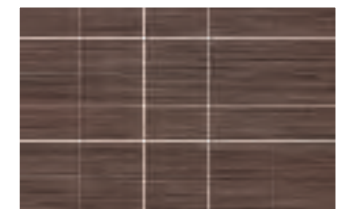

Coffee  
Brushed Mosaic NB1844

## Brushed ceramic floor tiles 333 x 333mm

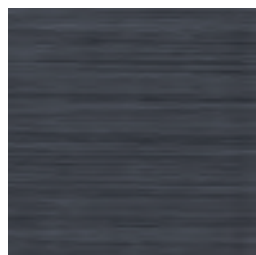

Black  
Brushed NB1885



Silver Grey  
Brushed NB1865



Jasmine  
Brushed NB1805



Cappuccino  
Brushed NB1825

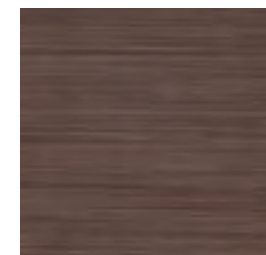

Coffee  
Brushed NB1845





# Affinity

## Ceramic wall tiles 270 x 420mm



Black  
Plain NB1880

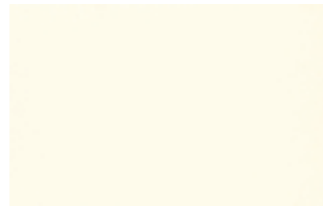

Warm White  
Plain NB1860

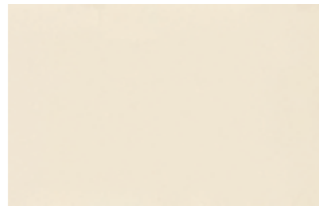

Jasmine  
Plain NB1800

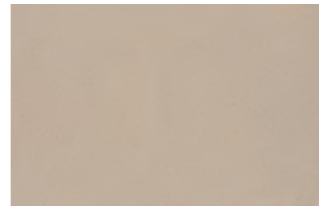

Cappuccino  
Plain NB1820

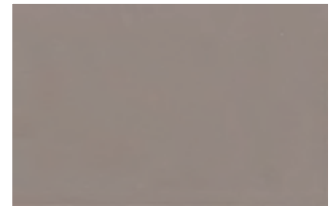

Coffee  
Plain NB1840



Black  
Plain Mosaic NB1881

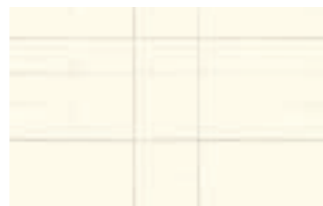

Warm White  
Plain Mosaic NB1861



Jasmine  
Plain Mosaic NB1801

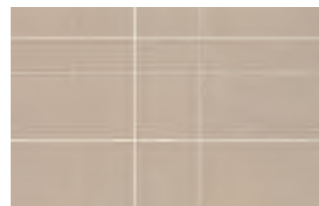

Cappuccino  
Plain Mosaic NB1821



Coffee  
Plain Mosaic NB1841



Dark Black  
Mixed Mosaic NB1887



Light Black  
Mixed Mosaic NB1886



Coffee  
Mixed Mosaic NB1846

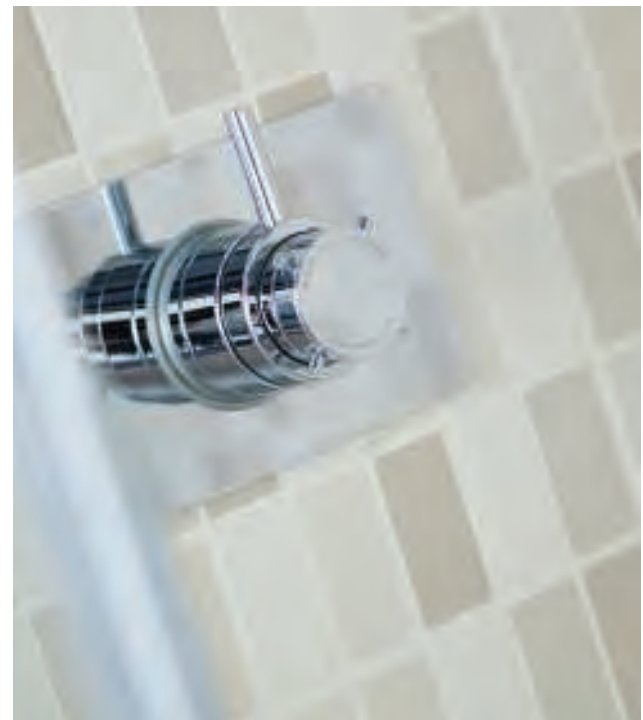







Sky





# Sky

Embrace the latest on-trend look with unobtrusive pastel tones with Sky, a ceramic wall and porcelain floor tile designed with the latest inkjet technology to incorporate a subtle cementitious and textured appearance which clearly helps to add a slight dimension to the tile.

Use Sky in your bathroom for a soft, refreshing look, or throughout the home to give the illusion of open space. Use Sky Décor, a randomised variation of colour in stick mosaic to create an lustrous, iconic feature wall in your room.

## Ceramic wall tile 200 x 500mm



Blue NB17910

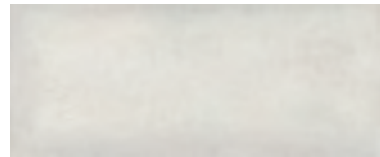

White NB17912

## Ceramic decor wall tile 200 x 500mm



Rise Blue NB17911



Rise White NB17913

## Ceramic mosaic wall tile 300 x 300mm



Lustre Blue NB17914



Lustre White NB17915

## Porcelain floor tile 471 x 471mm

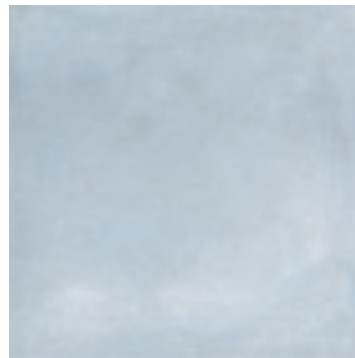

Blue NB17916

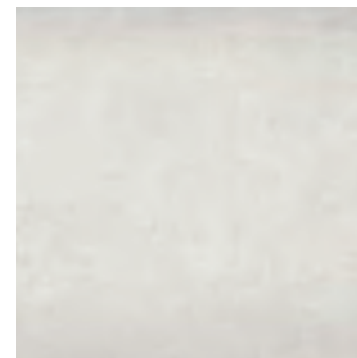

White NB17917







# Split Face

A range that is set on three levels to add a sense of depth and dimension to your walls. Split Face is produced with glazed porcelain which means that it can be used in wet areas with a 1mm grout joint, or can be butt jointed if used in a dry area. Internal and external pieces available.

## Porcelain wall tiles 150 x 610mm



Slate Black NB18285



Slate Cream NB18286



Slate Brown NB18287



Slate Multicolour NB18288

## Porcelain angled wall tiles 95 x 195 x 150mm



Internal Angle  
Slate Black NB18289  
Slate Cream NB18290  
Slate Brown NB18291  
Slate Multicolour NB18292



External Angle  
Slate Black NB18293  
Slate Cream NB18294  
Slate Brown NB18295  
Slate Multicolour NB18296











Future Stone







# Future Stone

---

The latest, innovative inkjet technology enables you to benefit from the intricate beauty of natural marble whilst attaining the benefits of ceramic wall and porcelain floors.

## Ceramic wall tiles 270 x 420mm



White NB18390



Bone NB18392



Grey NB18394

## Ceramic overlap decor wall tiles 270 x 420mm



White NB18391



Bone NB18393



Grey NB18395

## Ceramic wall tiles 300 x 600mm



White NB18378



Bone NB18380



Grey NB18382

## Ceramic overlap decor wall tiles 300 x 600mm



White NB18379



Bone NB18381



Grey NB18383



Ceramic wall tiles 300 x 900mm



Bone NB19400



Grey NB19402

Ceramic decor wall tiles 300 x 900mm



Bone NB19401



Grey NB19403





# Future Stone

---

Porcelain floor tiles 450 x 450mm

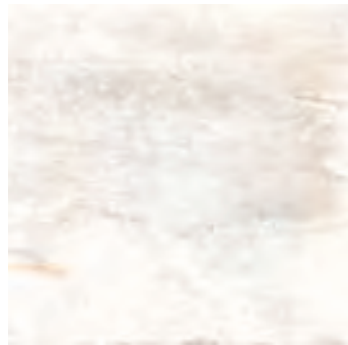

Bone NB18384



Grey NB18385

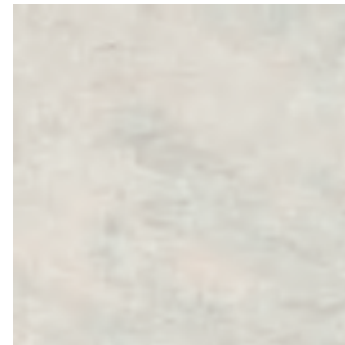

White NB18386

Porcelain floor tiles 600 x 600mm



Bone NB19404

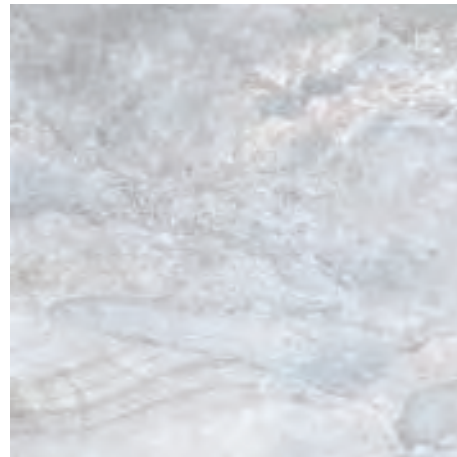

Grey NB19405



Black NB19406







# Civic

Replicate the natural beauty of stone with Civic, a varied natural stone tile look with a modern interpretation. Perfect for use around the home or in a commercial environment for a neutral setting.

Ceramic wall tiles 250 x 350mm

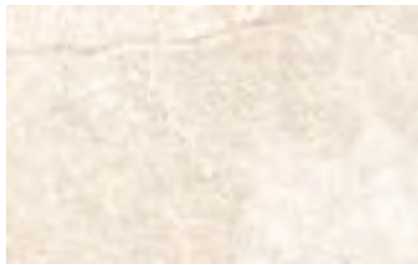

Beige NB17932



Gris NB17933

Ceramic stick mosaic decor wall tile 250 x 350mm



Beige NB17934



Gris NB17935

Porcelain floor tile 330 x 330mm

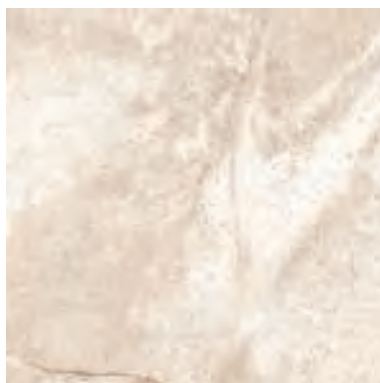

Beige NB17936



Gris NB17937

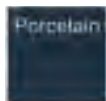





# Surface

Surface is our most dynamic range that allows you to extend your existing spaces from room to room for a seamless environment throughout the home, office or commercial setting. The range consists of 'IN' for internal rooms made from rectified porcelain and 'OUT', made from unrectified porcelain for an extension of the environment externally. The 'OUT' look achieves an impressive Pendulum Test Value (PTV) of >36, Surface is practical, reliable and elevates the look of your space.

## Porcelain wall and floor tiles 600 x 600mm - IN



Dark Graphite NB18995



Light Graphite NB18994

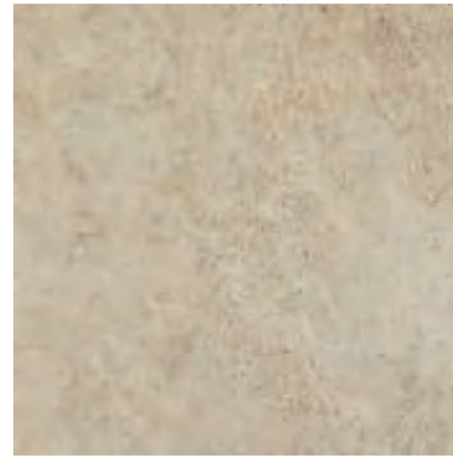

Sand NB18993



Warm White NB18992

## Porcelain wall and floor tiles 300 x 600mm - IN



Dark Graphite NB18999



Light Graphite NB18998



Sand NB18997

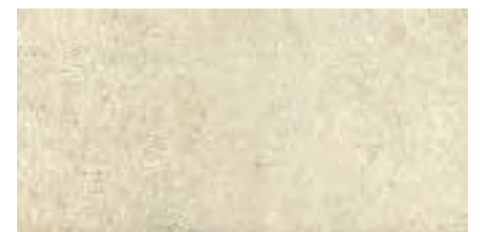

Warm White NB18996

## Porcelain wall and floor tiles 300 x 600mm - OUT



Dark Graphite NB19003



Light Graphite NB19002



Sand NB19001



Warm White NB19000

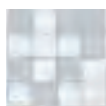







Wood Grove







# Wood Grove

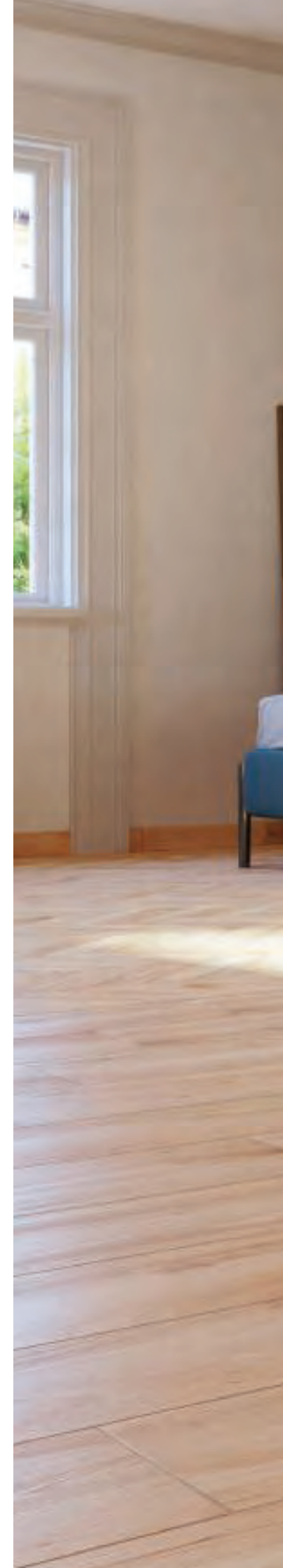
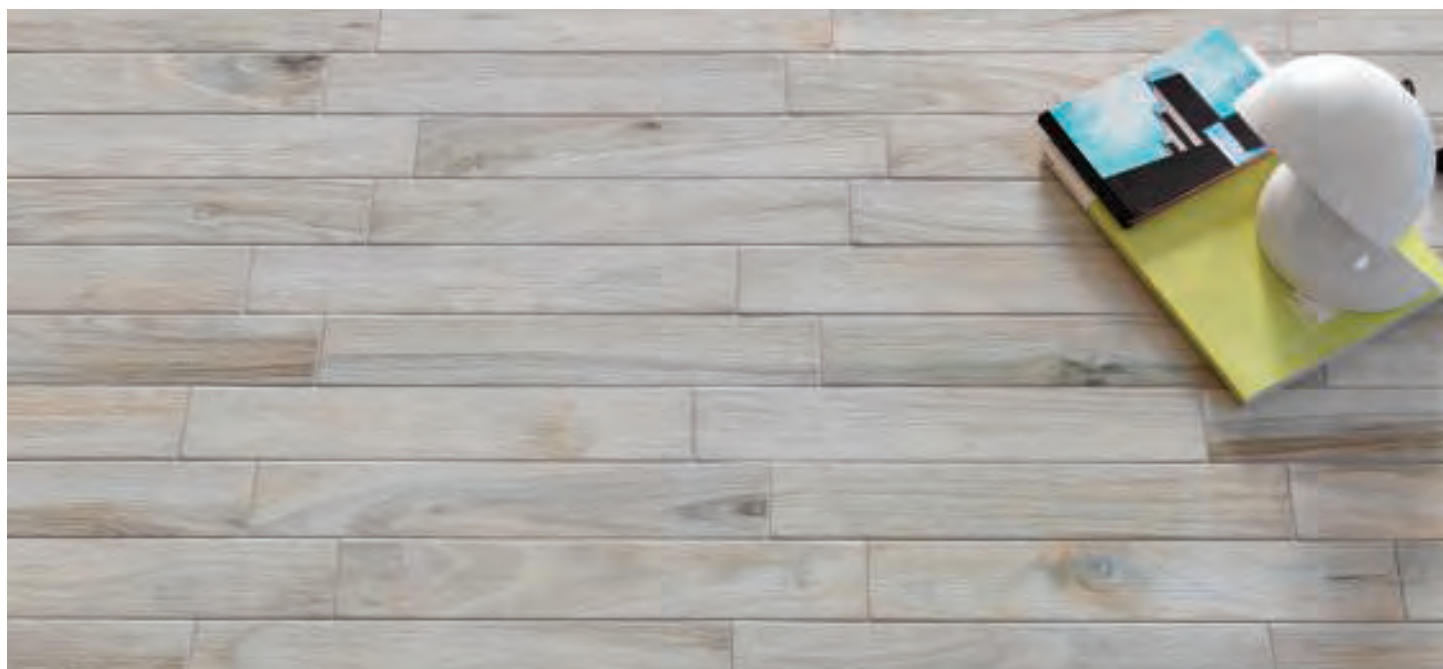







# Wood Grove

A wood-effect porcelain tile collection designed by a leading Italian designer. Available in warm, classic shades (Beige and Brown) and cooler, more modern (Green, Blue, White), Wood Grove is able to bring a uniquely warm touch to any interior commercial or domestic.

## Porcelain floor tiles 240 x 1200mm



White NB18263



Brown NB18266



Blue NB18264



Beige NB18267

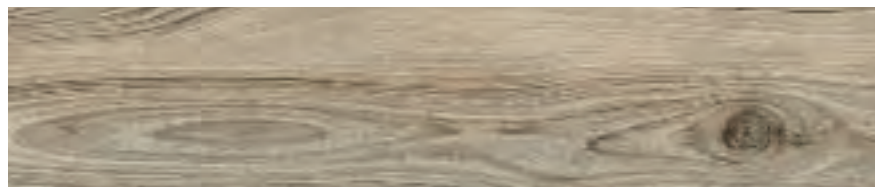

Green NB18265

## Porcelain floor tiles 75 x 450mm



White NB18268



Brown NB18271



Blue NB18269



Beige NB18272



Green NB18270

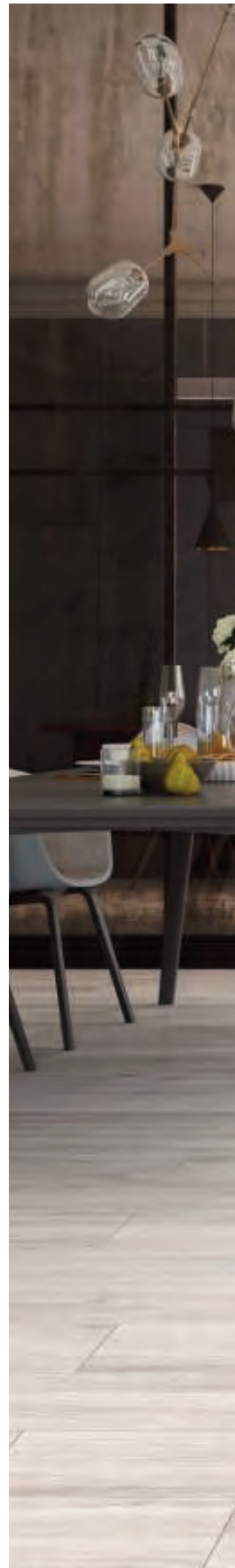





# Concept

A contemporary looking tile range that combines the subtle detailing of marble in on-trend, modern colours. This versatile range is perfect for use throughout the home and commercial setting. A must-have range for house builders looking for a all round good tile range to add their portfolio.

## Ceramic wall tiles 250 x 600mm



White NB17920



Pearl NB17922



Graphite NB17924



White Tempo Decor NB17921



Pearl Tempo Decor NB17923



Graphite Tempo Decor NB17925



Graphite Sarenne Decor NB17926

## Ceramic floor tiles 300 x 300mm

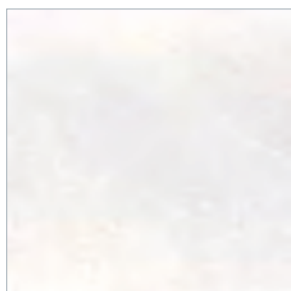

White Greco NB17927

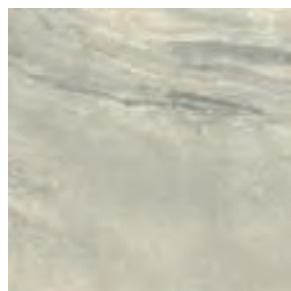

Pearl Greco NB17928



Graphite Greco NB17929













Castello







# Castello

---

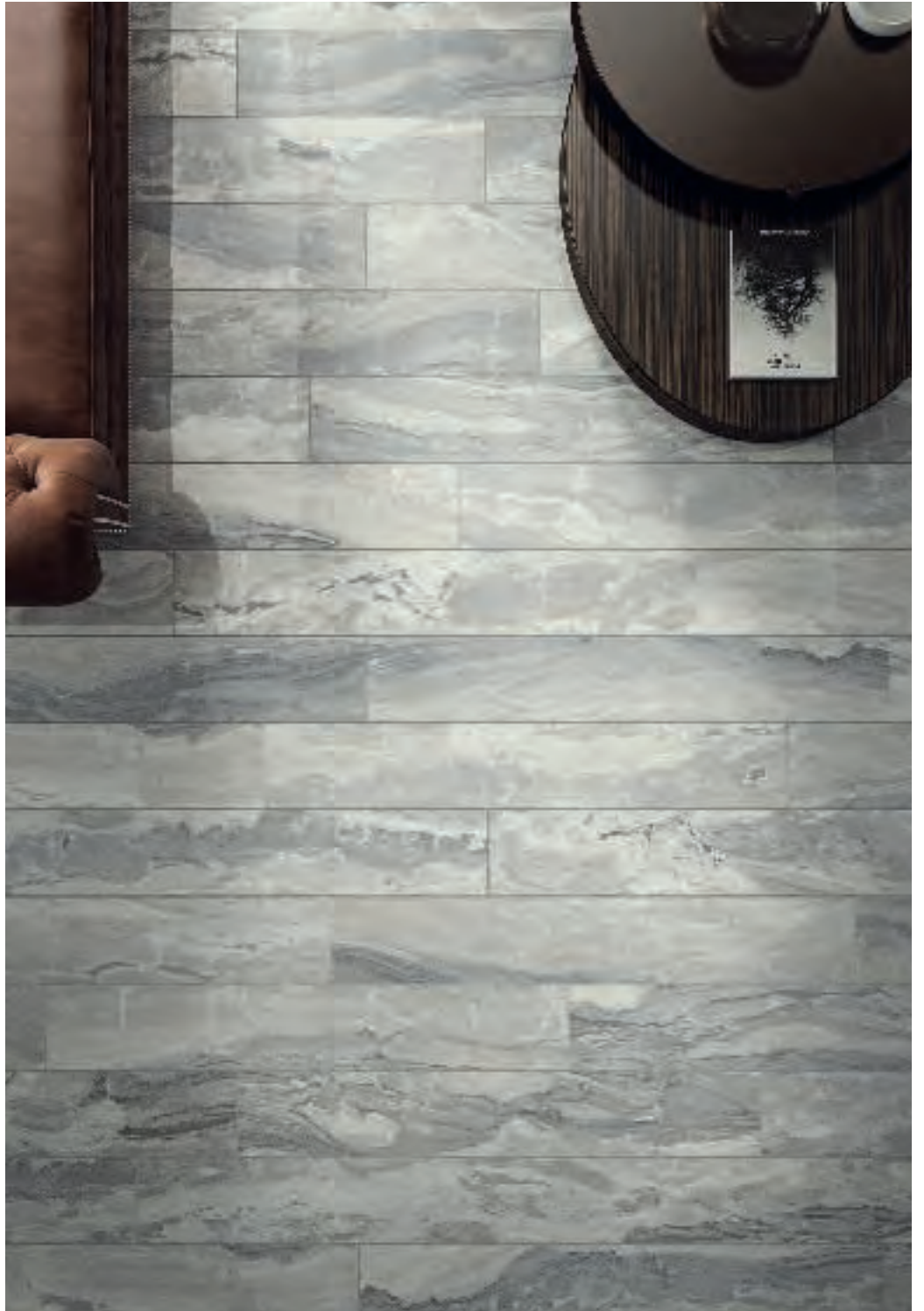



# Castello

Castello catches the strong and defined character and heavy veining found typically in Indian marble. Contemporary colors such as white, black, grey and blue interpret the nature of marble in an innovative way. The collection, available in two finishes, natural and lapato polished, is versatile and perfect to personalise and to refine residential and commercial spaces.

Porcelain wall and floor tiles 600 x 1200mm



Balmoral White Lapato Polished NB17820



Windsor Black Lapato Polished NB17825

Porcelain wall and floor tiles 200 x 1200mm



Balmoral White Lapato Polished NB17821  
Balmoral White Natural NB17822



Windsor Black Lapato Polished NB17826  
Windsor Black Natural NB17827

Porcelain wall and floor mosaic 300 x 300mm



Balmoral White Lapato Polished NB17823  
Balmoral White Natural NB17824

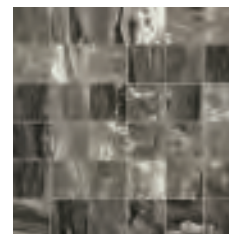

Windsor Black Lapato Polished NB17828  
Windsor Black Natural NB17829



Note: All natural finish items are available to special order.  
All mosaics lapato and natural are available to special order.

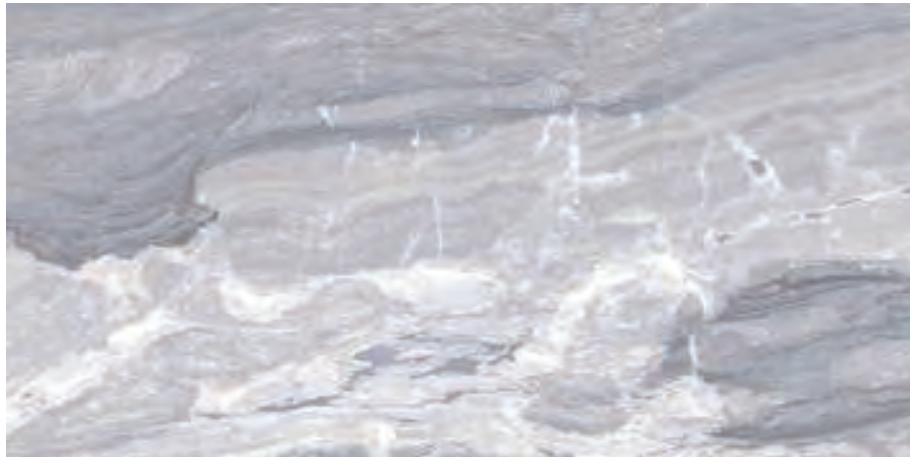

Chambard Grey Lapato Polished NB17830



Prague Blue Lapato Polished NB17835



Chambard Grey Lapato Polished NB17831  
Chambard Grey Natural NB17832



Prague Blue Lapato Polished NB17836  
Prague Blue Natural NB17837

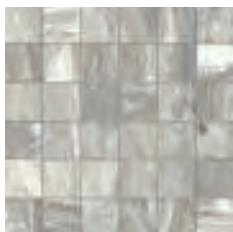

Chambard Grey Lapato Polished NB17833  
Chambard Grey Natural NB17834

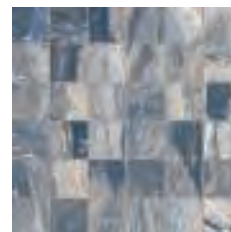

Prague Blue Lapato Polished NB17838  
Prague Blue Natural NB17839



Smart









# Smart

Smart is an impressive linear, structured wall tile with a gorgeous lustrous glaze, finished beautifully with rectified edges. Smart represents affordable luxury, offering choice and individuality. Smart offers a myriad of options to create a unique space, making it perfect for residential and commercial use.

Choose from either the structured 'Multistone' design or beautiful 'Multiwave' decorative element, and combine with their co-ordinating, solid colour plain tiles for a unique designer look where the design possibilities are endless.

## Ceramic wall tiles 250 x 600mm

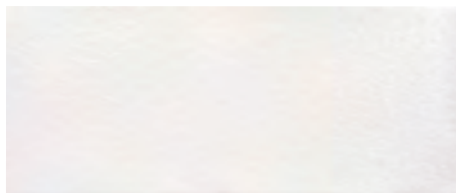

White NB18445

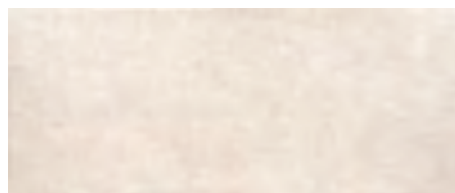

Bone NB18446

## Ceramic wall tiles 250 x 600mm



Multistone White NB18447



Multistone Bone NB18448



Multiwave Dune Decor NB18449

## Rectified ceramic wall tiles 300 x 900mm



White NB19042

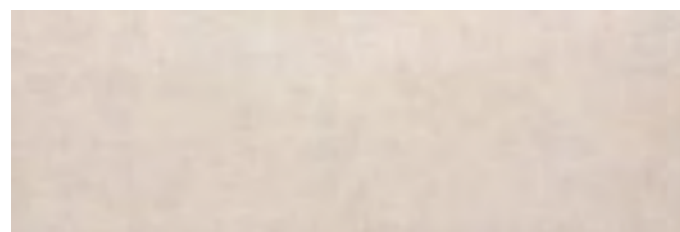

Bone NB19040

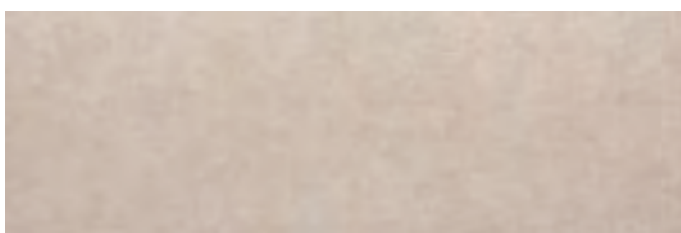

Sand NB19041







# Smart

---

Rectified ceramic wall tiles 300 x 900mm



Multistone Dark Grey NB19048



Multistone Light Grey NB19047



Multistone Bone NB19043



Multistone White NB19046



Multistone Sand NB19044



Multistone Greige NB19045



Multiwave Warm Mix Decor NB19049









# Gala

On trend, brick shaped wall tiles that are perfect for injecting a look of opulence with its high shine finish to any room within the home or commercial space. Create an eye catching herringbone splashback or feature wall in broken bond layouts or traditional bonded joints.

Wall tiles 80 x 333mm



Oro Gold NB18540



Antracite Black NB18541









\*theoffice







# Merge

Merge Hexagons highlight the epitome of on trend design with hexagon shaped tiles offered in our multi tone Synergy palette of colours. The traditional pattern design with a 'lived in' look achieves a revived effect. Merge cleverly fuses vintage chic with contemporary appeal to offer a range that is dynamic and can be used to fulfill individual design aspirations and tastes. Create a carpet area effect or use on larger areas to create the perfect statement design.

Porcelain floor tiles 250 x 220mm



Cool Multi Mix  
NB18986



Cool Multi Mix Decor  
NB18987



Warm Multi Mix  
NB18988



Warm Multi Mix Decor  
NB18989

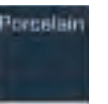







# Cemento

---

Our Cemento range represents the on trend theme of industrial chic and fashionable cosmopolitan in the home and commercial spaces. Cemento has been perfectly designed with the realistic natural variation of cement, with added visual dimension and character to lift the appeal of a room.

Porcelain floor tiles 600 x 600mm



Dark Grey NB19022



Light Grey NB19023



Warm White NB19025

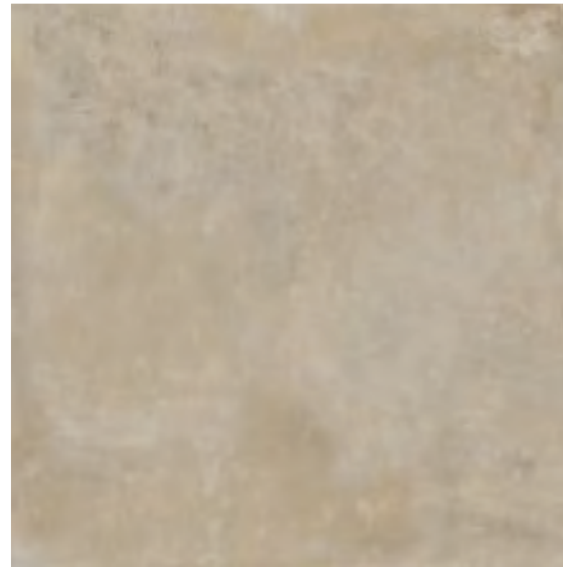

Beige NB19024





# Wood Stone

A statement floor that offers a random mix of tiles in all areas of the home or commercial space. Perfect for a restaurant setting or bar wanting to achieve an on-trend look. There are 48 faces per colour allowing for virtually zero repeats.

Porcelain wall and floor tiles 100 x 300mm

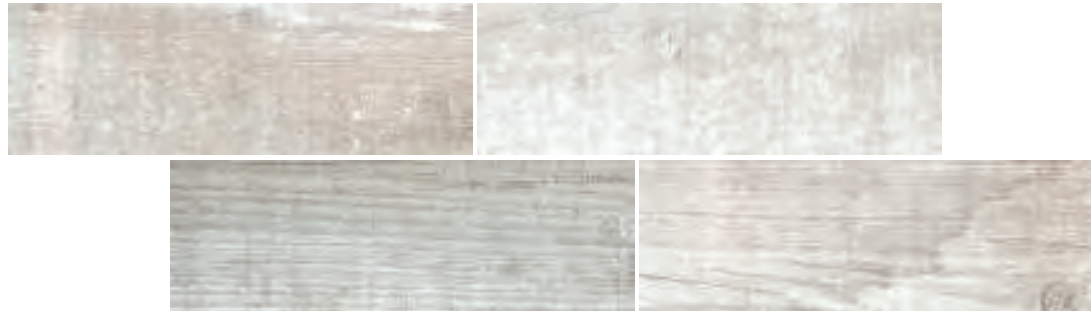

White NB18615



Graphite NB18616

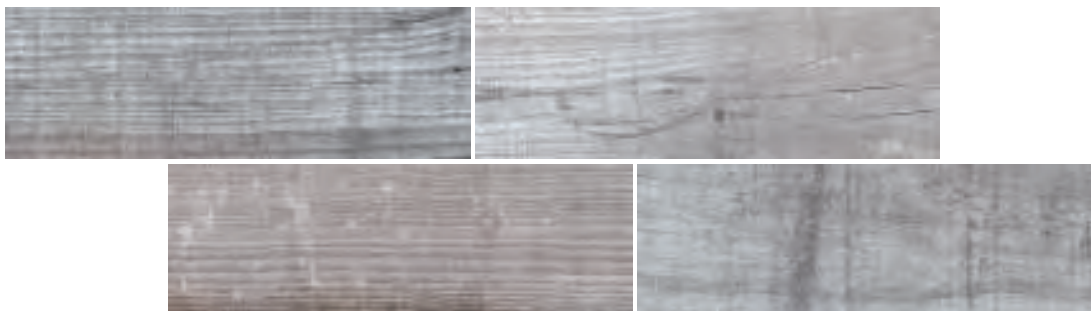

Forest NB18617













# Geology

A varied, multistone tile range that offers a large format tile option and a contrasting linear 150 x 600mm format for the creation of a feature wall or floor when installed as landscape or portrait stack bond, brick effect or random staggered.

## Porcelain wall and floor tiles 600 x 600mm



Dark Graphite NB19027



Light Graphite NB19028



Alabaster NB19030



Sand NB19029

## Porcelain wall and floor tiles 150 x 600mm



Dark Graphite NB19031



Light Graphite NB19032



Alabaster NB19034



Sand NB19033

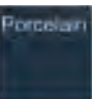



# Tracia

Create impact with Tracia, a range that uses digital ink-jet technology to create a lightly varied stone imitation with hints of onyx.

Porcelain wall and floor tiles 400 x 600mm



Grey NB18328



Beige NB18329









# Metallica

Metallica is a sophisticated range that incorporates a metallic sheen over the tile. combine with a herringbone mosaic which is mesh backed for ease of installation.

Porcelain wall and floor tiles 316 x 635mm



White NB18276



Black NB18277

Porcelain mosaic tiles 281 x 281mm



White NB18278



Black NB18279









Progress









# Progress

Progress is a comprehensive porcelain range of wall and floor tiles, with complementing mosaics made up by 6 cool and warm on-trend colours. Maximise the sense of space in a home or commercial environment, such as shopping centres, offices or spas with this oversized porcelain tile to create visually unified and sophisticated interiors. The range consists of 'IN' for internal rooms made from rectified porcelain and 'OUT', made from unrectified porcelain for an extension of the environment externally. With an impressive Pendulum Test Value (PTV) of >36.

## Porcelain wall and floor tiles - 443 x 888mm - IN

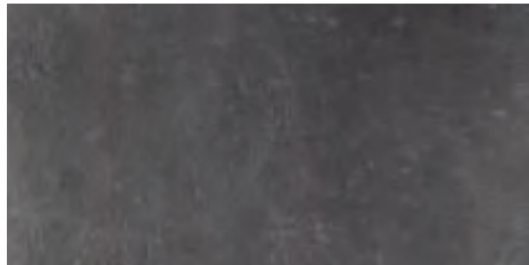

Black NB18977 - IN



Dark Grey NB18976 - IN



Silver Grey NB18974 - IN

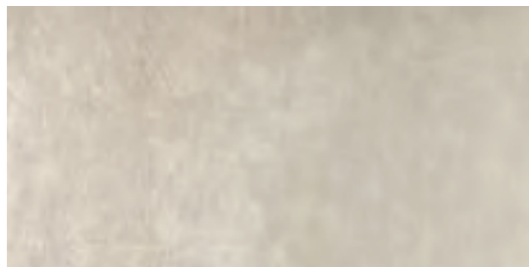

Alabaster NB18972 - IN



Stone NB18973 - IN



Clay NB18975 - IN

## Porcelain wall and floor tiles - 443 x 888mm - OUT (PTV >36)



Black NB18983 - OUT

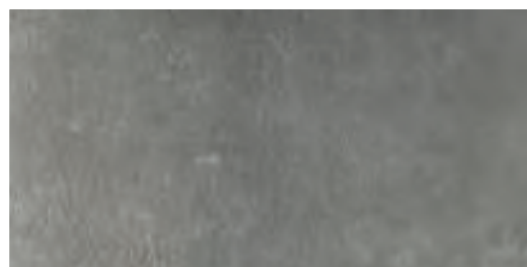

Dark Grey NB18982 - OUT



Silver Grey NB18980 - OUT

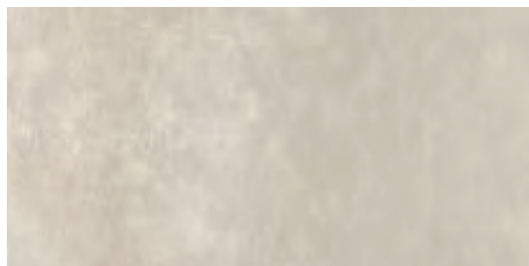

Alabaster NB18978 - OUT



Stone NB18979 - OUT



Clay NB18981 - OUT







Porcelain mosaic wall and floor tiles 295 x 295mm - IN



Black Mosaic  
NB18969 - IN



Dark Grey Mosaic  
NB18968 - IN



Silver Grey Mosaic  
NB18966 - IN



Alabaster Mosaic  
NB18964 - IN



Stone Mosaic  
NB18965 - IN



Clay Mosaic  
NB18967 - IN

Porcelain

V2



# Wood Living

A contemporary twist on a traditional looking wooden floor that is available in 6 Synergy inspired colourways. A range that is easy to handle and install, .

Porcelain wall and floor tiles 150 x 600mm



Noce NB17784



Maple NB17787



Oak NB17785



Grey NB17789



Beech NB17786



Ice NB17788









# Wood Direction

A statement floor designed to create an on-trend chevron format. The unique range utilises clever manufacturing to offer easy and quick installation.

Porcelain wall and floor tiles 700 x 400mm



White Right Hand NB18166



White Left Hand NB18167



Camel Right Hand NB18168



Camel Left Hand NB18169

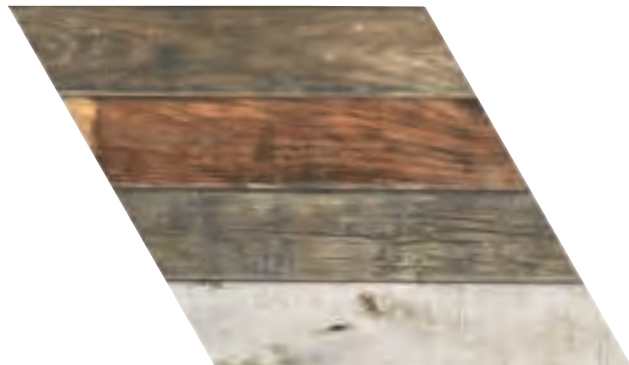

Mix Right Hand NB18170



Mix Left Hand NB18171

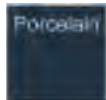







# Chess

Opt for a classic look with Chess, an easy choice to be used individually or combined for a seamless look. the matt finish gives it a softer appearance across a floor.

Porcelain wall and floor tile 330 x 330mm

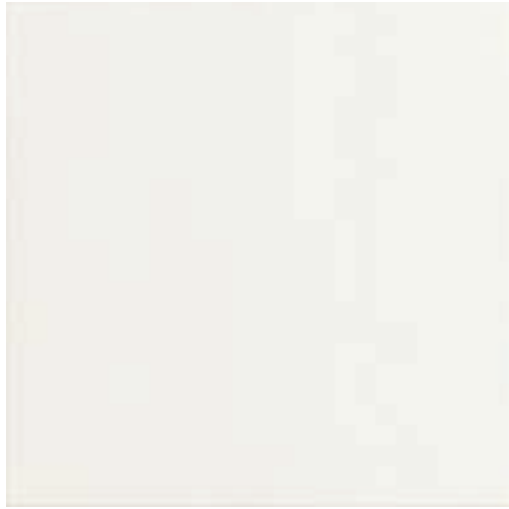

White NB17940



Black NB17941

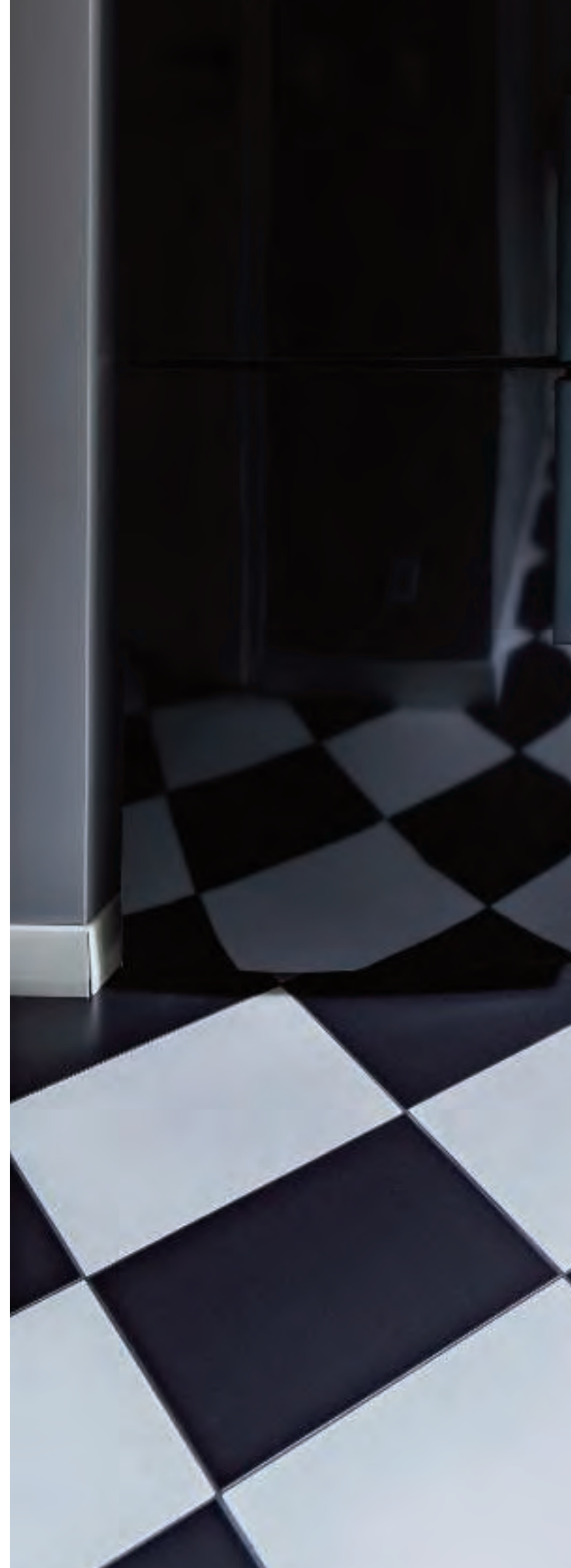







# Statuario

Statuario features the beauty and opulence of classic marble but with the practicality of porcelain. Statuario is finished with an attractive polished finish and is available in 4 popular formats, as well as 2 mosaic designs, squares and hexagons.

## Porcelain wall and floor tiles

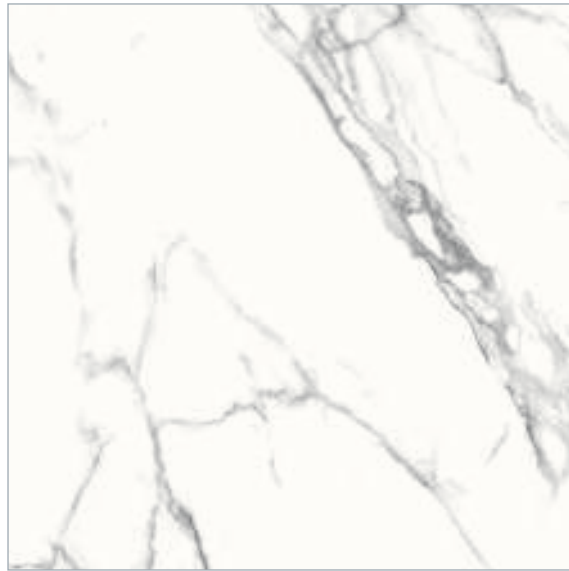

NB17970 - 900 x 900mm

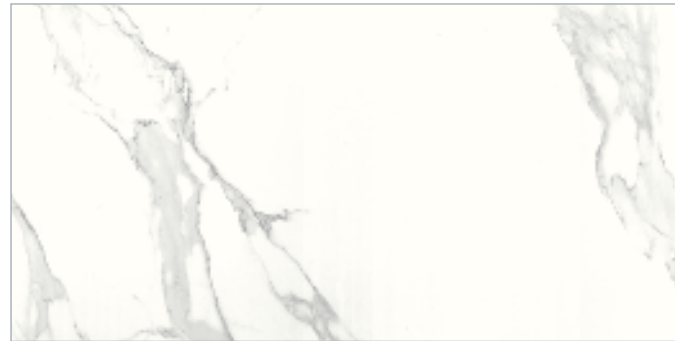

NB17971 - 1200 x 600mm



NB17972 - 600 x 600mm



NB17973 - 300 x 600mm

## Porcelain wall and floor mosaic tiles 300 x 300mm



Hexagon Mosaic  
NB17974



Square Mosaic  
NB17975









# Shift

Satin metallic effect glazed porcelain wall tile perfect for combining with other synergy options for a metallic decorative feature wall, zone, border etc. The angular structure lends itself to contemporary décor schemes.

Porcelain wall tiles 330 x 330mm



Oro Gold NB18160



Antracita Silver NB18161



V2

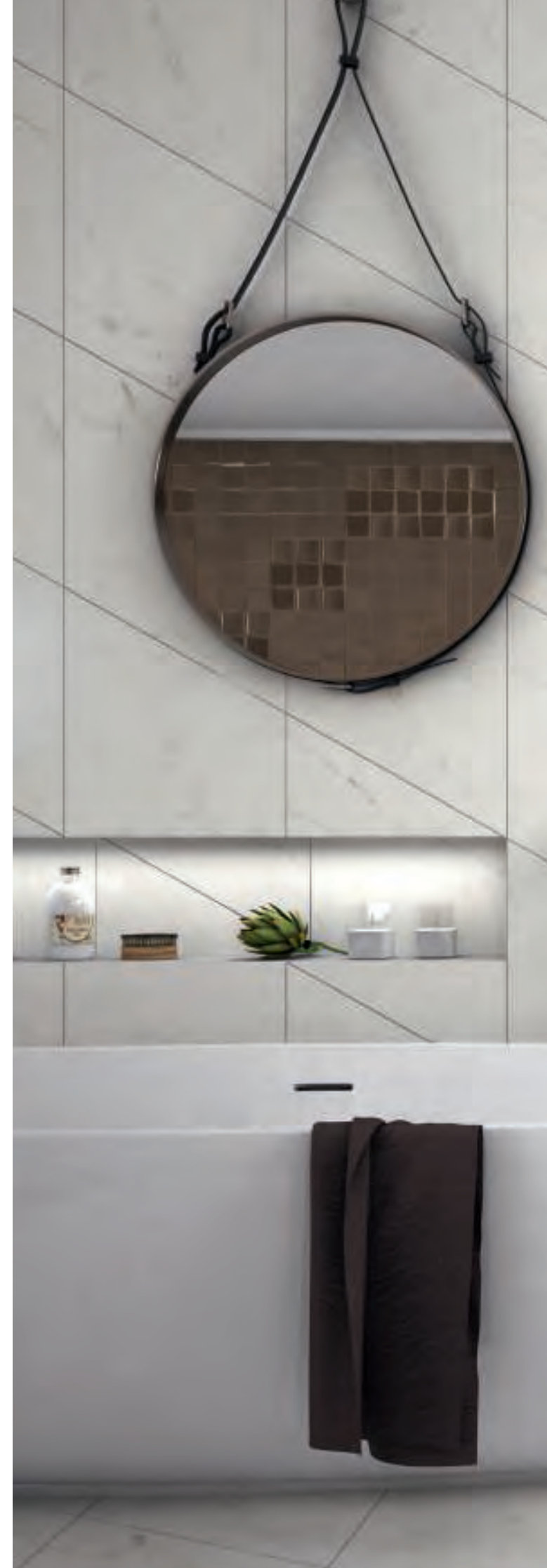









Time

---







# Time

The Time range is our most comprehensive collection, enabling us to offer our clients choice and flexibility. Time is constructed of rectified full bodied porcelain stoneware, with high level of technical characteristics offered in a blend of warm and cool tones, true to the ethos of Synergy. Time offers a complete range for the demanding requirements of modern architecture, being the ideal solution for both wall and floor from residential through to commercial spaces.

Double loaded porcelain wall and floor tiles 600 x 600mm

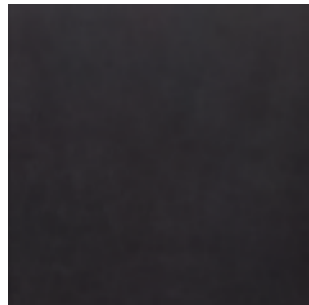

Black  
Natural Rectified NB18753  
Polished NB18763  
Anti-Slip NB18773



Carbon  
Natural Rectified NB18758  
Polished NB18768  
Anti-Slip NB18775



Grey  
Natural Rectified NB18757  
Polished NB18767

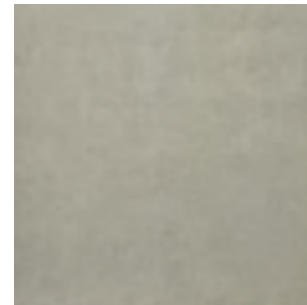

Silver  
Natural Rectified NB18752  
Polished NB18762  
Anti-Slip NB18772



Snow  
Natural Rectified NB18750  
Polished NB18760  
Anti-Slip NB18770

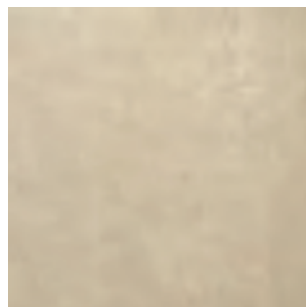

White  
Natural Rectified NB18754  
Polished NB18764

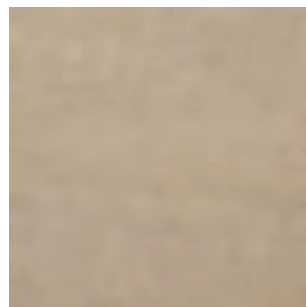

Cream  
Natural Rectified NB18751  
Polished NB18761  
Anti-Slip NB18771

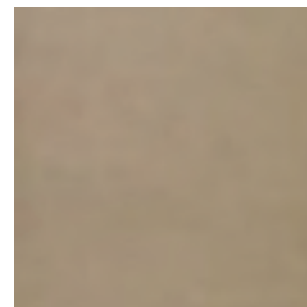

Beige  
Natural Rectified NB18755  
Polished NB18765  
Anti-Slip NB18774



Dove  
Natural Rectified NB18756  
Polished NB18766

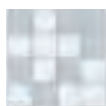



Double loaded porcelain wall and floor tiles 300 x 600mm



Black  
Natural Rectified NB18783  
Polished NB18793  
Anti-Slip NB18803



Carbon  
Natural Rectified NB18788  
Polished NB18798  
Anti-Slip NB18805



Grey  
Natural Rectified NB18787  
Polished NB18797

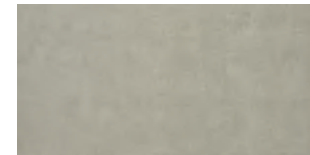

Silver  
Natural Rectified NB18782  
Polished NB18792  
Anti-Slip NB18802

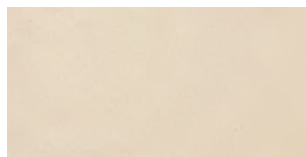

White  
Natural Rectified NB18780  
Polished NB18790  
Anti-Slip NB18800

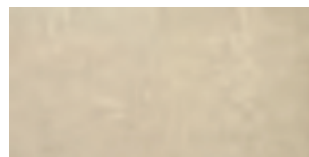

Snow  
Natural Rectified NB18784  
Polished NB18794

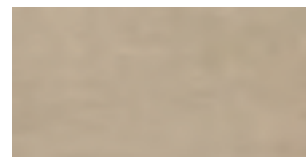

Cream  
Natural Rectified NB18781  
Polished NB18791  
Anti-Slip NB18801

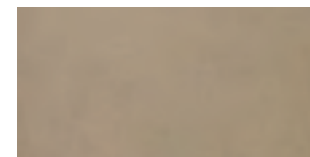

Beige  
Natural Rectified NB18785  
Polished NB18795  
Anti-Slip NB18804

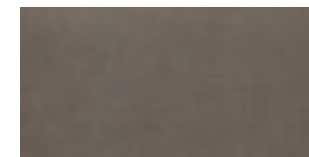

Dove  
Natural Rectified NB18786  
Polished NB18796

Double loaded porcelain mosaic wall and floor tiles 300 x 300mm



Black Natural  
Mosaic NB18844

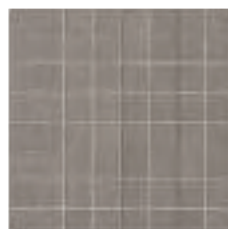

Carbon Natural  
Mosaic NB18849

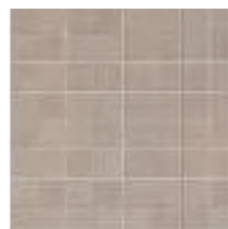

Grey Natural  
Mosaic NB18848



Silver Natural  
Mosaic NB18843



White Natural  
Mosaic NB18845



Snow Natural  
Mosaic NB18841



Cream Natural  
Mosaic NB18842



Beige Natural  
Mosaic NB18846



Dove Natural  
Mosaic NB18847

# Time

---

Double loaded porcelain wall and floor tiles 900 x 900mm

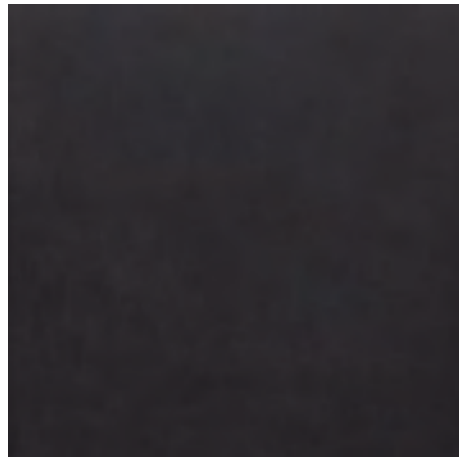

Black  
Natural Rectified NB18693  
Polished NB18703



Carbon  
Natural Rectified NB18695  
Polished NB18705

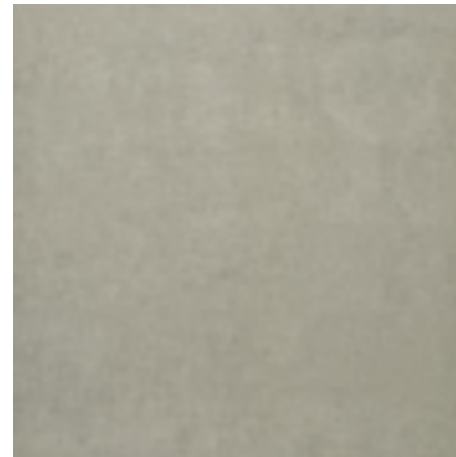

Silver  
Natural Rectified NB18692  
Polished NB18702



Snow  
Natural Rectified NB18690  
Polished NB18700

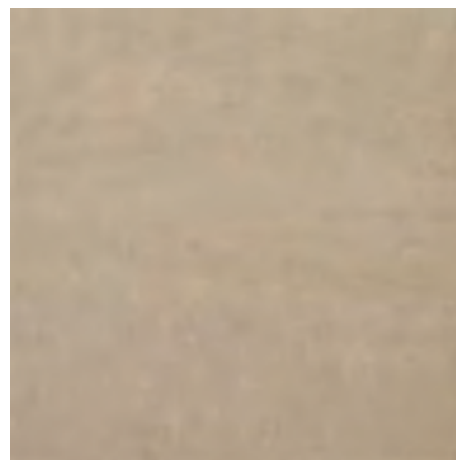

Cream  
Natural Rectified NB18691  
Polished NB18701

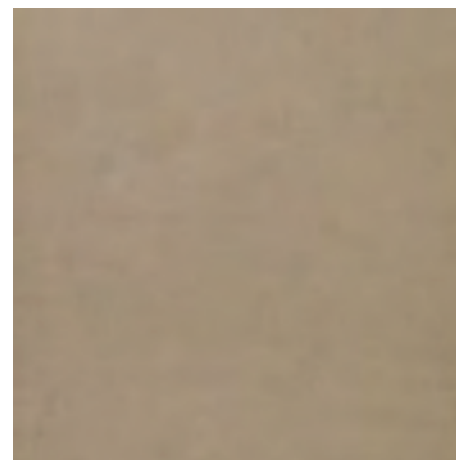

Beige  
Natural Rectified NB18694  
Polished NB18704

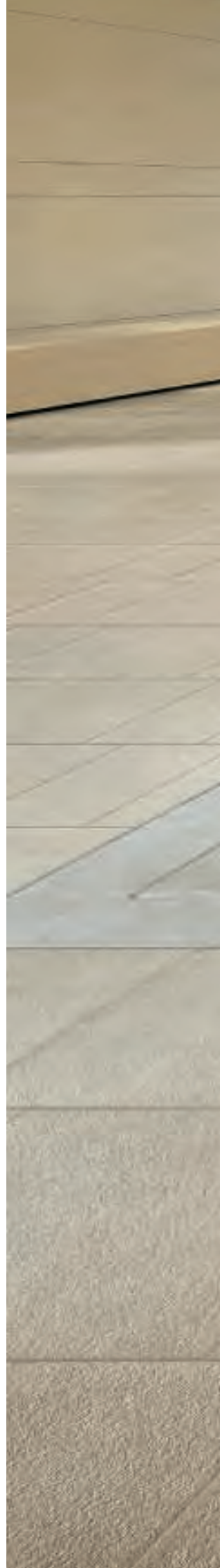





# Slim Time

Slim Time is a unique designer led, decorative wall and floor porcelain that offers clients pure spatial amplitude and design edge. Innovation meets sophistication with Slim Time, a sheet porcelain tile designed to boast the ultimate in on-trend, sophistication and class.

Sheet porcelain 3.5mm floor and wall 1000 X 3000mm - 1000 x 1000mm - 1000 x 500mm



1000 X 3000mm  
1000 x 1000mm  
1000 x 500mm

Black  
NB18927  
NB18920  
NB18913

Carbon  
NB18929  
NB18922  
NB18915

Silver  
NB18926  
NB18919  
NB18912

Snow  
NB18924  
NB18917  
NB18910

Cream  
NB18925  
NB18918  
NB18911

Beige  
NB18928  
NB18921  
NB18914











Wood Nature











## Wood Nature

---





# Wood Nature

A inspirational range of wood effect tiles that very closely replicates luxury real wood, such as Mahogany, yet attains the benefits of porcelain. Wood Nature is a highly flexible range that can be used on walls, floors and outdoors. Create a continuation of your living space from inside to your garden or patio area. The Synergy inspired colours means that this dynamic range can be used with a wide array of co-ordinating elements for the ultimate on trend aesthetic.



\* Step-nosing, drainage channels and grids available to special order.





# Wood Nature

---

Porcelain wall and floor tiles 200 x 1800 x 10mm

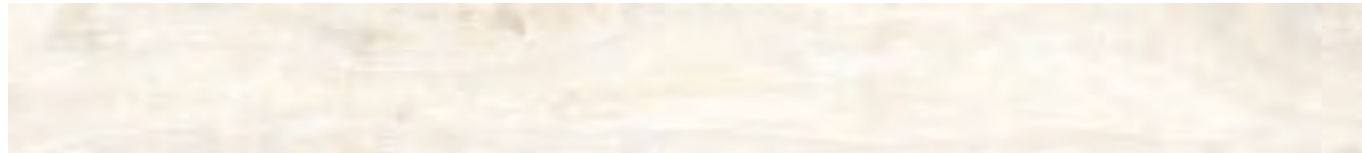

Arara NB18140



Kamba NB18141



Matis NB18142



Nawa NB18143



Tuxa NB18144





Porcelain wall and floor tiles 400 x 1200 x 20mm



Arara NB18145



Nawa NB18148



Kamba NB18146

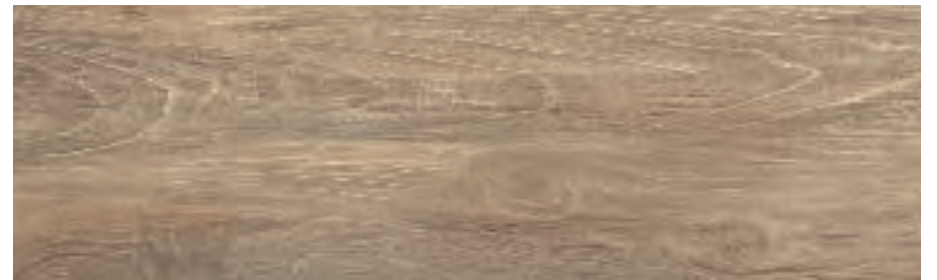

Tuxa NB18149



Matis NB18147



Landscape









# Landscape

---

Landscape, our 20mm thick porcelain range has been designed for external environments through its construction, designed to be stronger and more reliable than stone, yet lightweight for use on a balcony or where structural problems may be an issue. Used with the matching 10mm version for internal use, Landscape coordinates and extends the perceived living space from inside the home or commercial space to outdoors. With excellent frost, water, flex, scratch, stain, mould and fire resistance, Landscape boasts superb functional qualities and characteristics. It can be installed using either dry fit, loose laid or bonded method.

Specialist variations are available for the ultimate flexibility, including steps, coping stones, lights and pedestals. The Landscape series boasts an impressive Pendulum Test Value (PTV) of >36 for added peace of mind regardless of the chosen thickness.

## Porcelain floor tiles 600 x 600 x 20mm - OUT



Black Rectified NB18657



Mid Grey Rectified NB18656



Pearl Grey Rectified NB18655

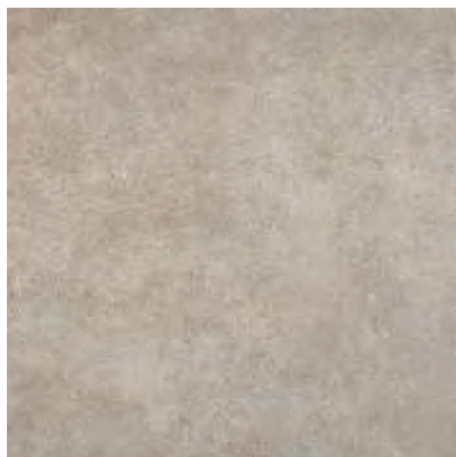

Stone Rectified NB18658

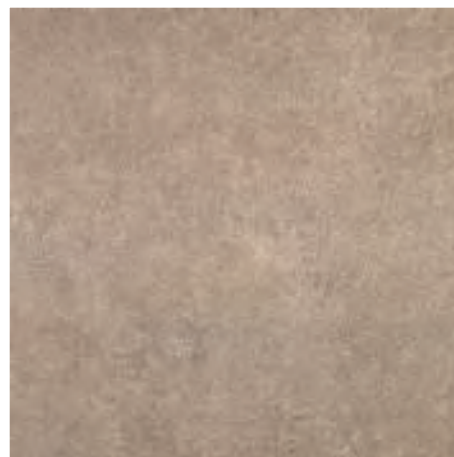

Clay Rectified NB18659





Porcelain wall and floor tiles 590 x 590 x 10mm - IN



Black Rectified NB18652



Mid Grey Rectified NB18651



Pearl Grey Rectified NB18650

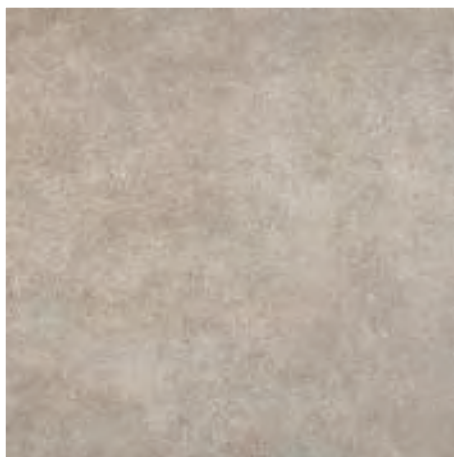

Stone Rectified NB18653



Clay Rectified NB18654

# Landscape

For the ultimate flexibility, we offer clients a vast range of special pieces to complete an outdoor tiling project, regardless of the chosen installation method. The special pieces have been created to ensure continuity in the design, with complementing pieces that maintain a high level of technical characteristics and aesthetics. From drainage pieces and nosing's, to integrated lighting and angled borders, flexibility is at the heart of Landscape.



## Edge Nosings and Accessories



Integrated Light



Pool Drainage



External Angle with Pool Drainage



Skirting Piece



150mm Edge Nosing



200 x 600mm Edge Nosing



300 x 600mm Edge Nosing



600 x 600mm Edge Nosing



Step External Angle Edge Nosing



External Angle Edge Nosing



Internal Angle Edge Nosing









Landscape







Flexibility in the installation allows you to fix Landscape in three different ways. The installation methods consist of traditional bonding, using large format tile adhesive, dry fit installation onto grass or gravel, or pedestal installation using, fixed or height adjustable supports.

The raised paving system is quick and easy to install, with a raised platform that allows for pipework to be hidden underneath. It acts as an acoustic barrier and air chamber for thermal insulation.

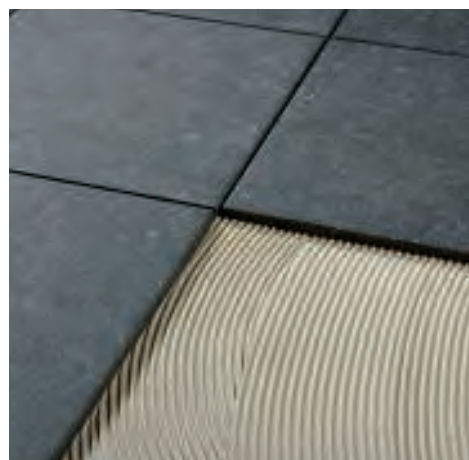

Fully bonded installation is perfect for driveways, commercial and industrial sites and access ramps.

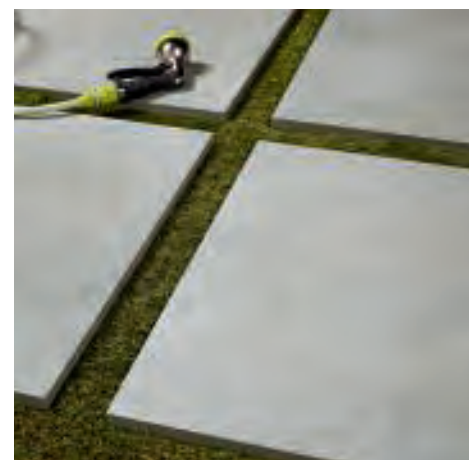

Loose laid install is ideal for lawns, pathways or decorative greenhouse subfloors.



Loose laid on to gravel creates an easy to lay patio area.

## The benefits of the Nicobond Terra-Level system

### Fast installation

No need for mortars or adhesives, so no drying or curing time and can be fitted in wet and cold conditions.

### Easy installation

No need to breach the substrate before installing the system, so no heavy plant or machinery needed.

### Flexible heights

Heights from 1cm to 103cm can be safely achieved and slopes up to 10° can be compensated, suitable in nearly all situations

### High stability

No moving or self-levelling parts, so the elevated floor tiles are unable to move, offering long term stability and no need for any future adjustments.

### Exceptional drainage

Joints created naturally during the installation process means water can easily drain away, so pooling of water will not occur.

### Permanent ventilation

Voids created below the elevated floor allows for free movement of air, so the area always dries quickly.

### Services management

Space created below an elevated floor allows services to remain hidden and protected, so no unsightly cable or pipe trip hazards.

### Special construction

Pedestals are made from special plastics, so each one can carry 1 metric tonne in weight.



Mosaics









# Mosaics



Upgrade your interior design scheme using our collection of the latest mosaics, designed to inspire individuality and the creation of feature walls or zonal areas.

The addition of mosaics and accents of colour in a neutral palette enhances the overall look, adding personality and style. Our range of on-trend quality mosaics feature a mix of shapes, colours and materials from natural stone to metals and glass in multi colour or single colour options.

Mosaics are perfect for injecting a focal point in the home, or for incorporating brand colours into a commercial environment. They are backed with a mesh sheet for easy application. combine with Nicobond Starlike Grout, available in a number of colours for the ultimate finishing touch.

We have collaborated with Sicis, an international leader in mosaics to compile a range that consists of a palette of colour that adheres to future trends and perfectly complements the Synergy Series.

# SICIS

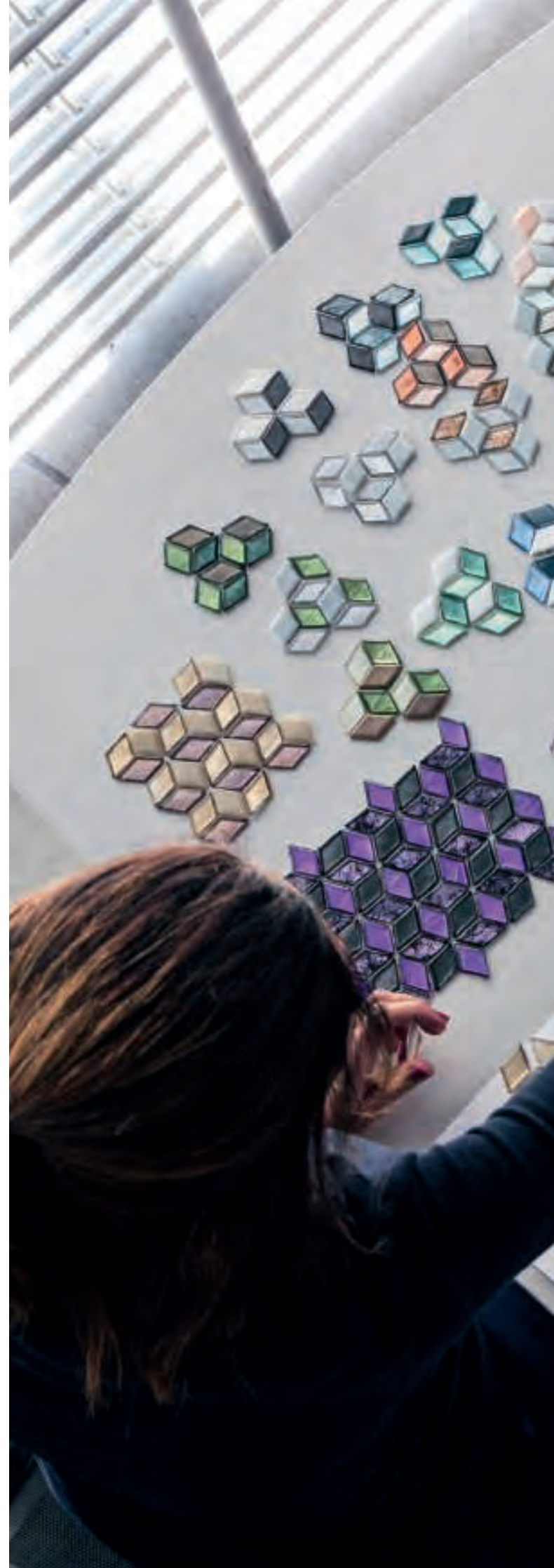





SICIS  
THE GEOMETRIC

DIAM

NO. 001

NO. 002

NO. 003

NO. 004









The three items shown within the grey line box are available from UK Stock, all other items are available to special order, enquire for details.

Diamond glass mosaic  
259 x 266mm



Cullinan Silver  
NB17700



Buvango Gold  
NB17701

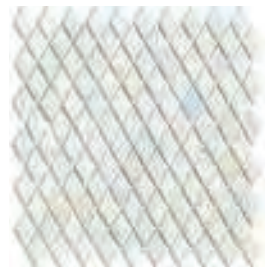

Excelsior Pearlescent  
White - NB17702



Jubilee  
NB17703



Mavinga  
NB17704



Nanorod  
NB17705



Umbo  
NB17706



Barite  
NB17707



Orapa  
NB17708



Brillante  
NB17709



Shah  
NB17710



Fuxian  
NB17711



Baroda  
NB17712



Solitario  
NB17713

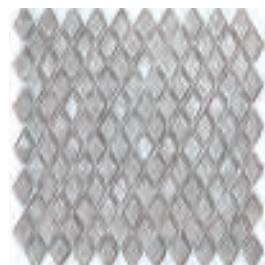

Kimberlite  
NB17714

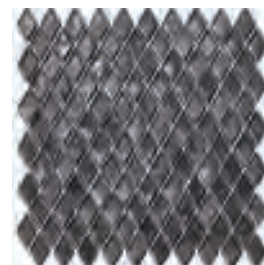

Caesium  
NB17715

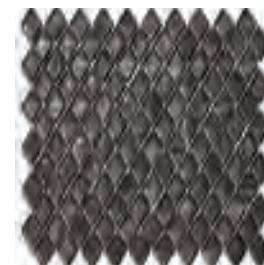

Surat  
NB17716



Alnatt  
NB17717

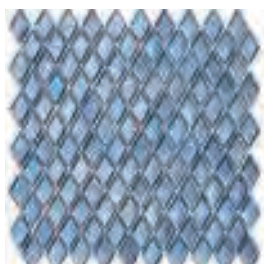

Nunavut  
NB17718



Basin  
NB17719

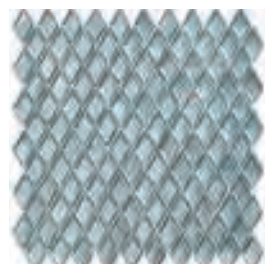

Scotia  
NB17720

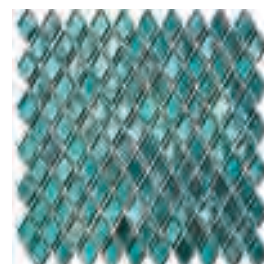

Regent  
NB17721



Dresden  
NB17722

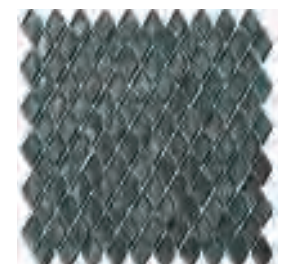

Palladium  
NB17723

mark text



# Mosaics

Clarity  
300 x 300mm

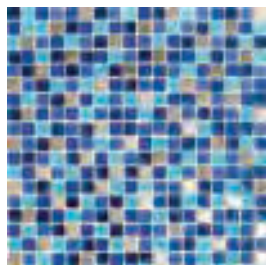
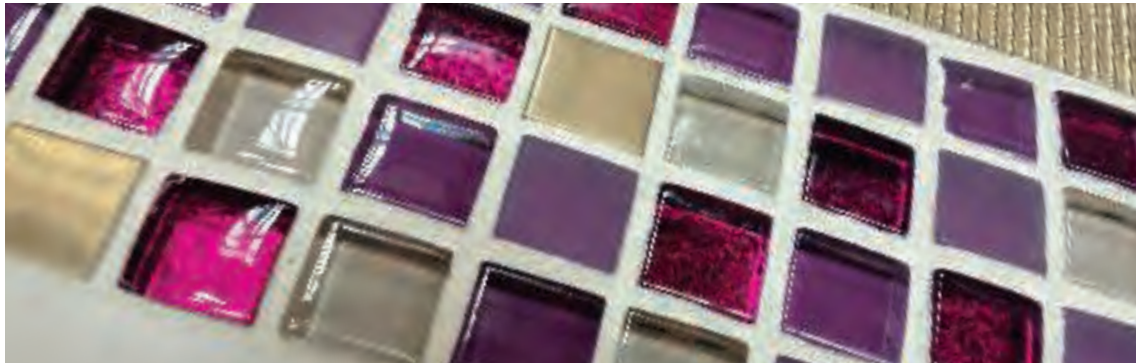

Clarity Cobalt  
NB19609

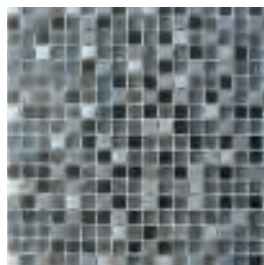

Black/Silver  
NB1280

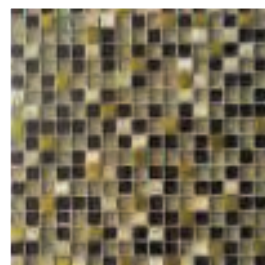

Clarity Cream/Marron/Gold  
NB1279

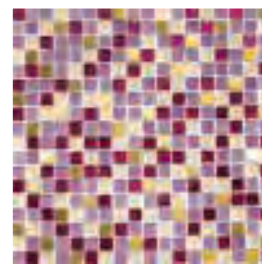

Clarity Berry  
NB19608

Linear Glass  
300 x 300mm

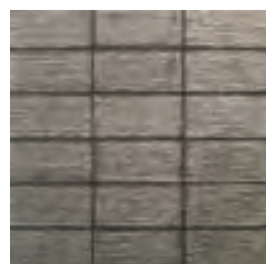

Linear Glass Bronze  
NB19191

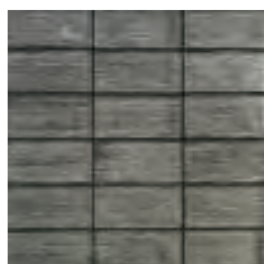

Linear Glass Titanium  
NB19192

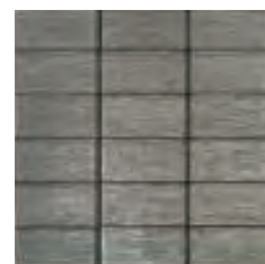

Linear Glass Silver  
NB19193





Hexagon Glass  
310 x 290mm

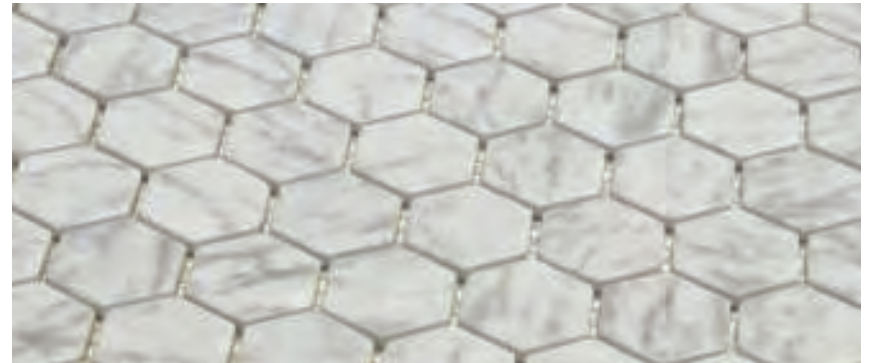

Hexagon Glass Black  
NB19130

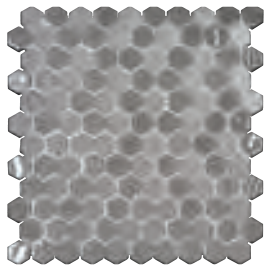

Hexagon Glass Grey  
NB19131

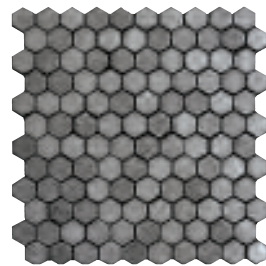

Hexagon Glass Dune  
NB19133

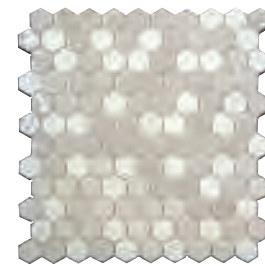

Hexagon Glass White  
NB19132

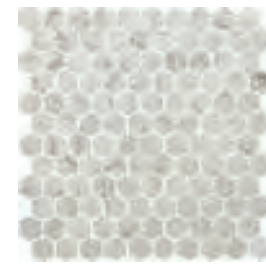

Hexagon Glass Carrara  
NB19134

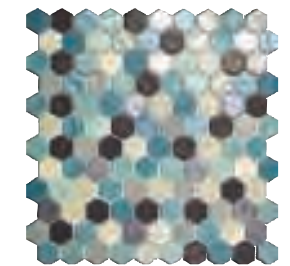

Hexagon Glass  
Aquamarine NB19135

3D Metal/Glass  
300 x 300mm

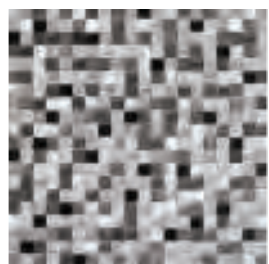

3D Cool Metal/Glass  
NB19610



3D Warm Metal/Glass  
NB19611

Stone Glass  
300 x 300mm

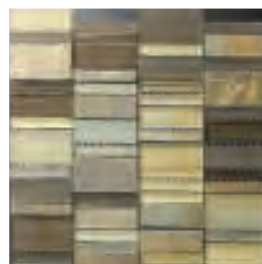

Stone Glass Cinnamon  
(interlocking) NB19185

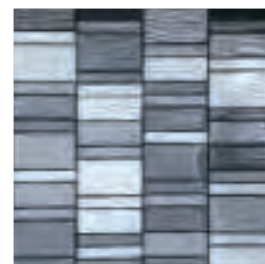

Stone Glass Nutmeg  
(interlocking) NB19187

Jewel  
300 x 300mm

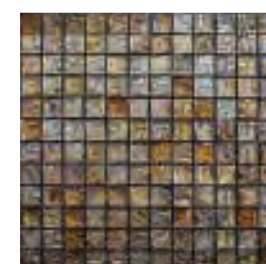

Jewel Bronze  
NB19168

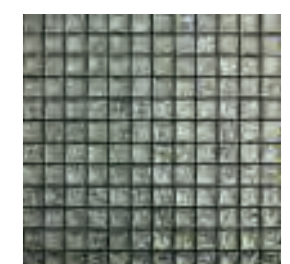

Jewel Silver  
NB19169



Synergy Furniture

Complete the look with Synergy furniture, shower trays and panels...



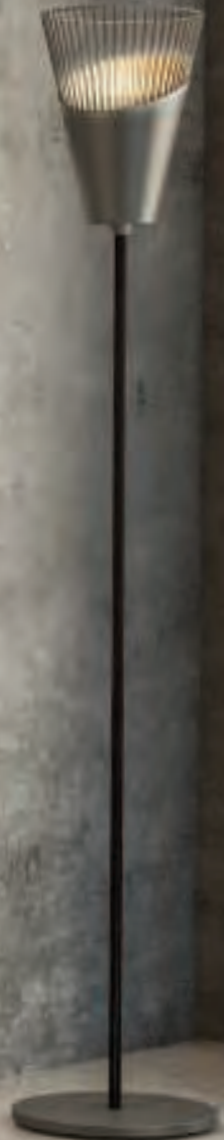



# Modular Furniture

Flexibility is at the heart of the modular range, with an endless choice of co-ordinating colours and configurations. The high quality materials used in manufacturing each component ensures durability, quality and attractive looking products. The modular wall hung units allow you to combine the different units to any configuration to suit the requirements of the given space, with our moulded 12mm basin tops to suit.

## Wall Hung Units

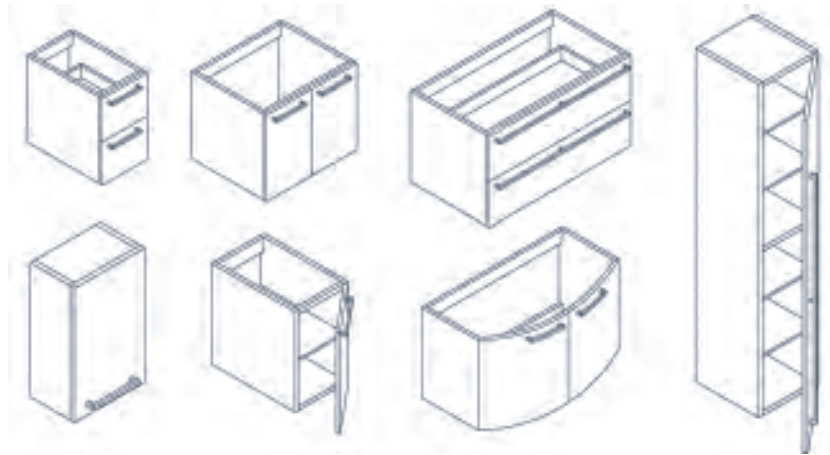

Our 18mm thick wall hung units are available in either matt or gloss lacquer, 3 wood finishes and 6 warm and cool tones that stay true to the Synergy concept. The units are modular, allowing complete flexibility in the chosen configuration with basins to suit. All units feature a soft close mechanism as standard,



## Ultima Shower Trays

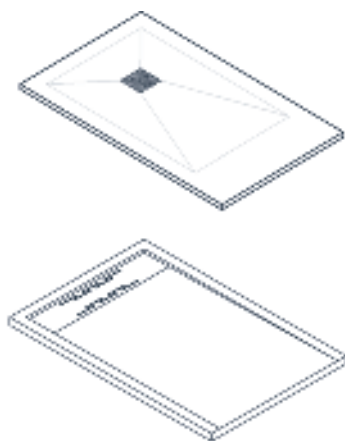

Linear and standard drainage options available. Made using 30mm marble composite construction, 5 different styles and 23 size options.

## Basins

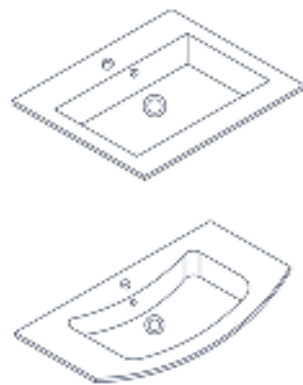

Our 12mm cast marble basin tops are made from 75% natural minerals and are available in either matt or gloss finishes.

## Wall Boards



Our colour coordinating 6mm shower panels are the perfect addition to any bathroom. Available in 500x2000, 600x2000 and 700x2000mm.









# Modular Furniture



## Colours and finishes

Our Synergy Bathroom Furniture range has a variety of colours available to suit your colour requirements. Whether you would like a light colour to brighten up a dark wall or dark furnishings to make a bold statement on a lighter wall.

### Matt/Gloss Finish



Deep Grey



Elegant Grey

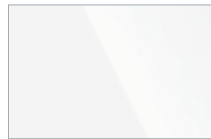

White



Autumn Beige



Mandorla



Vintage Brown

### Wood



Cigar Wood



Ciliegio Tasmania

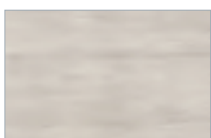

Pine Wood









# Paints, Grouts and Sealants

Complement your design scheme using our Synergy Paint offering which consists of a specially formulated palette of colours that perfectly complements the colours and tones within the Synergy Series.

We have collaborated with leaders in paint, Dulux, who have engaged in colour trend forecasting for over 15 years. Dulux, alongside our design and product team at N&C, we have together worked to produce a strong palette of colours that perfectly complements the Synergy Series, yet adheres to future consumer and commercial tastes in the interiors world.

## Choosing Colour

Undertones are the secret to understanding and selecting colours. Nearly every colour uses a mix of colours to produce the colour you can see. A yellow undertone to any colour will offer a warm tone, whereas a red undertone will offer a cooler undertone.

## Colour of the Year 2018

Our Synergy Paint Palette incorporates Dulux' Colour of the Year, Heart Wood, a smoky warm neutral with a hint of lavender. Heart Wood is a versatile colour that can be used across the Synergy Series.

## The Synergy Palette

**Diamond Eggshell** - available in 5 litre

Diamond Eggshell offers fantastic durability with stain repellent technology. Offering a mid sheen finish Diamond Eggshell is especially useful in spaces with high moisture such as kitchens and bathrooms

**Diamond Matt** - available in 5 litre

Diamond Matt offers unrivalled durability in a classic matt finish. Innovative stain repellent technology protects walls from scuffs and stains, keeping busy spaces looking good for longer.

**Vinyl Matt** - available in 1 litre, 2.5 litre and 5 litre

High opacity emulsion in a great finish for everyday use. Suitable for all normal interior wall and ceiling surfaces.

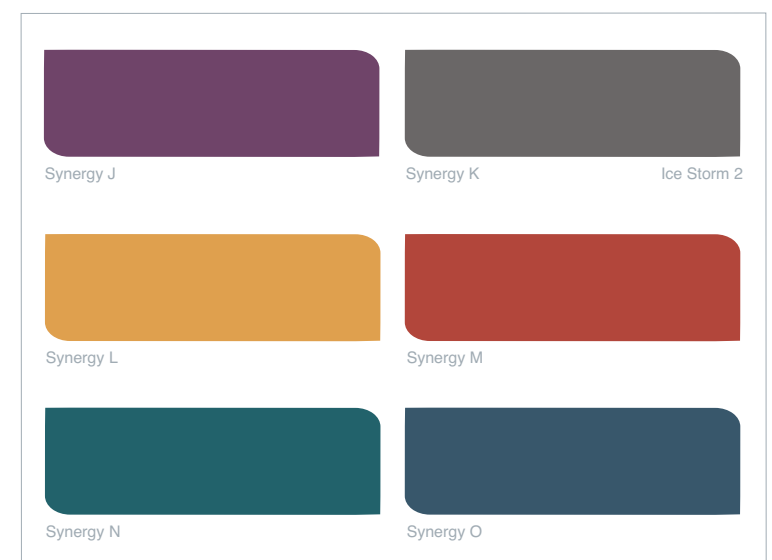
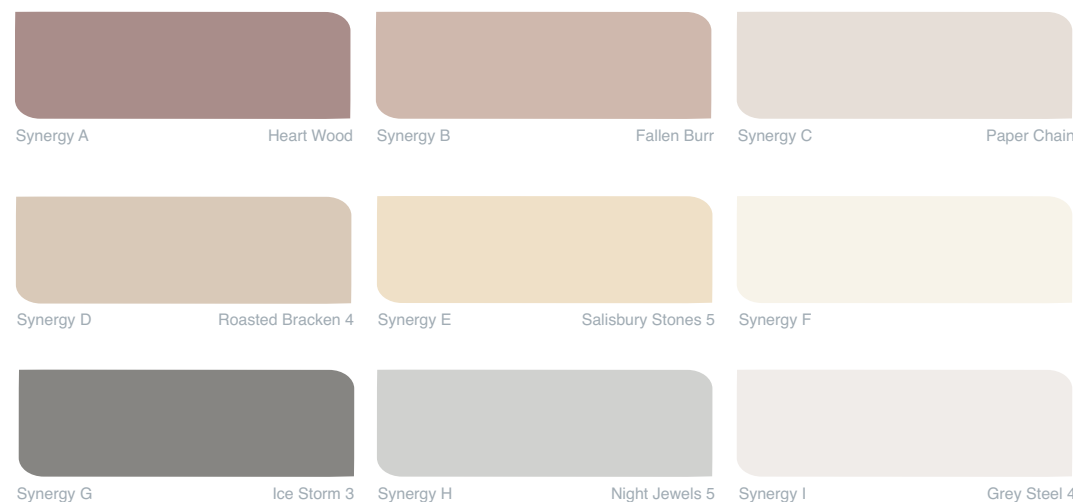

All Synergy colours are available in all three finishes





Paint: Heart Wood





### Silicone Sealant



Black



Silver Grey



White



Clear



Jasmine



Limestone



Light Coffee

### Nicobond Flexible Grout Plus

A superior highly flexible grout with anti efflorescence, anti mould and unique Aquablok technology. Suitable for wall and floor joint widths 2 – 20mm.



Black



Slate Grey

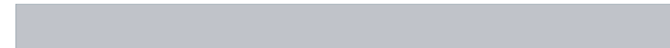

Mid Grey



Silver Grey



White



Jasmine

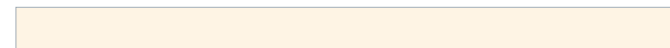

Cream

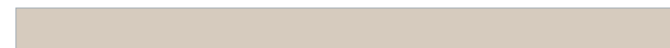

Limestone



Light Coffee

### Nicobond Starlike Grout

Nicobond Starlike Grout is waterproof, stain & mould resistant and is extremely easy to clean. It has superb acid resistant properties and is very easy to mix, apply & clean off. When fully cured, Nicobond Starlike Extreme Performance Grout provides an attractive, durable and chemical resistant finish to the tiled surface. Suitable for wall and floor joint widths up to 15mm.



Black



Slate Grey



Mid Grey



Silver Grey



White



Jasmine

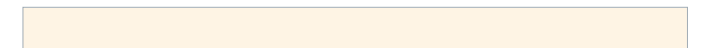

Cream

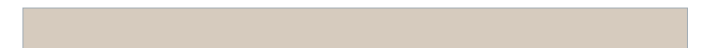

Limestone



Light Coffee



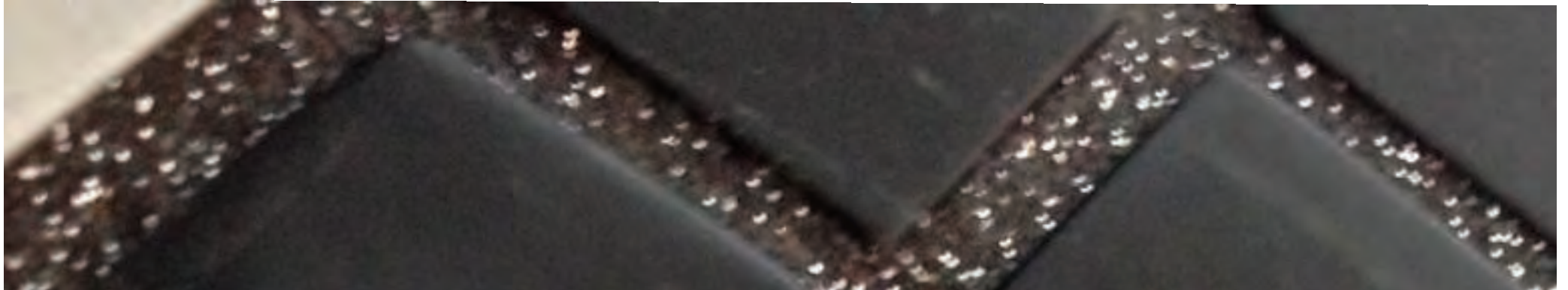

Nicobond Starlike Grout  
with Starlike Sparkle Galaxy



Black



Slate Grey



Mid Grey



Silver Grey

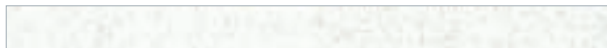

White

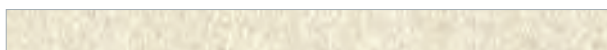

Jasmine

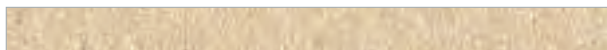

Cream

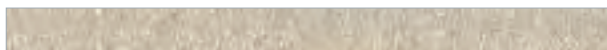

Limestone



Light Coffee

Nicobond Starlike Grout  
with Starlike Sparkle Silver



Black



Slate Grey



Mid Grey



Silver Grey



White



Jasmine



Cream



Limestone



Light Coffee

Nicobond Starlike Grout  
with Starlike Sparkle Gold



Black



Slate Grey



Mid Grey

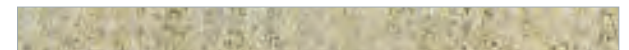

Silver Grey



White



Jasmine



Cream



Limestone



Light Coffee



# Synergy



MAffinity	38 - 43	Marbellous	20 - 29	Split-Face	48 - 49
Bevels	34 - 35	Merge	82 - 83	Statuario	104 - 105
Castello	68 - 73	Metallica	92 - 93	Surface	58 - 59
Cemento	84 - 85	Mosaic	132 - 139	Synergy Furniture	140 - 145
Chess	102 - 103	Paints, Grouts & Sealants		Time	108 - 113
Civic	56 - 57		146 - 149	Tracia	90 - 91
Concept	66 - 67	Progress	94 - 97	Whitewood	36 - 37
Future Stone	50 - 55	Shift	106 - 107	Wood Direction	100 - 101
Gala	80 - 81	Sicis Mosaic	134 - 137	Wood Grove	60 - 65
Geology	88 - 89	Sky	44 - 47	Wood Living	98 - 99
Highland	30 - 33	Slim Time	114 - 115	Wood Nature	116 - 123
Landscape	124 - 131	Smart	74 - 79	Wood Stone	86 - 87



# Total Solution *provider*



## WET ROOMS

As manufacturers of the complete system, N&C offer every component required to create a stylish, level access showering environment.



## ADHESIVES

We manufacture innovative, high performance adhesives, grouts and tiling systems through our Nicobond brand, within our UK based factory.



## GLASS & GLAZING

As the UK's leading independent supplier of commercial and domestic glass and glazing products, we can offer unrivalled solutions at competitive prices.

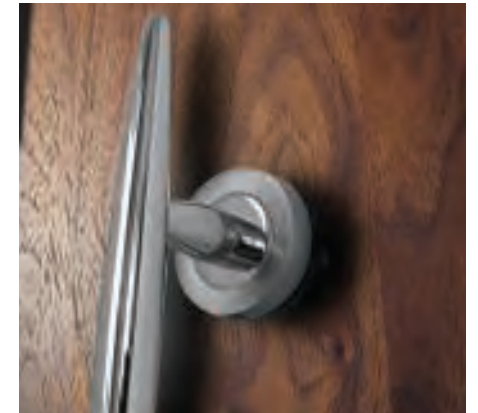

## IRONMONGERY

As Ironmongers since 1875, and as part of the Guild of Architectural Ironmongers, we specialise in everything required in washrooms



## FLOORING

As leading manufacturers, we provide quality materials for required safety flooring, such as Altro, vinyl tiles and screeds.



## BATHS

From contemporary to classic, we have a broad collection of baths in a range of shapes and styles perfect for hotels.



## INDEPENDENT LIVING

Through our Phlexicare brand, N&C are leading manufacturers and distributors of independent living solutions designed for people with all levels of abilities, covering accessible showering, multi user kitchens and more.



## DECORATING

Our builders merchant division offers all the popular trade brands for decorators and building professionals.

The colours shown within this catalogue are as accurate as the limitations of the printing process will allow. The images of tiles shown in this catalogue are representative of the product but are not necessarily to scale.

Print cannot reproduce a true likeness of colour, tone or texture. Reference to a sample is essential.

Contact your local branch or Sales Representative for dedicated literature. Alternatively, visit [www.nichollsandclarke.com/downloads](http://www.nichollsandclarke.com/downloads).



## Distribution Centres, Trade Counters & Showrooms

N&C Building Materials  
 41-51 Freshwater Road  
 Chadwell Heath  
**Romford, Essex RM8 1SP**  
 Tel: 020 8586 4600  
 Fax: 020 8586 4646

26 Colquhoun Avenue  
 Hillington Industrial Estate  
 Hillington, Scotland  
**Glasgow G52 4BN**  
 Tel: 0141 880 1200  
 Fax: 0141 880 1212

Unit C1  
 Cothill Industrial Estate  
 Plympton, **Plymouth PL7 1SR**  
 Tel: 01752 339724  
 Fax: 01752 342746

Unit 4 Waterloo Industrial Estate  
 Flanders Road, Hedge End  
**Southampton SO30 2QT**  
 Tel: 01489 779700  
 Fax: 01489 779701

Units 3 & 4 Cardiff Trade Park  
 Hadfield Road, **Cardiff CF11 8AQ**  
 Tel: 029 2039 0146  
 Fax: 029 2022 4356

## Trade Counters & Showrooms

Units 1A/B Alexander Place  
 Lower Park Road  
**New Southgate**  
 London N111QD  
 Tel: 020 8361 6050  
 Fax: 020 8361 4757

Unit 9 -11 McDonald Business Park  
 Maylands Avenue  
**Hemel Hempstead**  
 Hertfordshire HP2 7EB  
 Tel: 01442 234635  
 Fax: 01442 279501

Unit 14 Meridian Trading Estate  
 Bugsby Way, **Charlton**  
 London. SE7 7SJ  
 Tel: 020 8269 5960  
 Fax: 020 8269 5961

Unit 8D Pompey Centre  
 Fratton Way Southsea  
**Portsmouth PO4 8TA**  
 Tel: 02392 894599  
 Fax: 02392 894598

Units 10, 11, 14 & 15  
 Advent Business Park  
 Advent Way  
**Edmonton N18 3AF**  
 Tel: 020 8807 3227  
 Fax: 020 8807 3223

Unit 5 Tower Court  
 St. David's Road Swansea  
 Enterprise Park  
**Swansea SA6 8QL**  
 Tel: 01792 797337  
 Fax: 01792 774019

Unit 8 Ascent Park  
 Edinburgh Way  
**Harlow, Essex CM20 2HW**  
 Tel: 01279 621980  
 Fax: 01279 621981

25 Gunnels Wood Park  
 Gunnels Wood Road  
**Stevenage**  
 Hertfordshire SG1 2BH  
 Tel: 01438 315400  
 Fax: 01438 740338

Unit1 Cliffside Trade Park  
 Motherwell Way  
**Lakeside, West Thurrock**  
 Essex RM20 3XD  
 Tel: 01708 680180  
 Fax: 01708 680181

Unit E5  
 Copley Hill Trading Estate  
 Whitehall Road  
**Leeds LS12 1HE**  
 Tel: 0113 243 5644

2 - 3 Albarn Close  
 Wyncolls Road  
 Severalls Park  
**Colchester Essex CO4 9HY**  
 Tel: 01206 849300  
 Fax: 01206 845878

Leofric House  
 Off Phoenix Way  
 Waterman Road  
**Coventry CV6 5TP**  
 Tel: 02476 705300  
 Fax: 02476 705301

