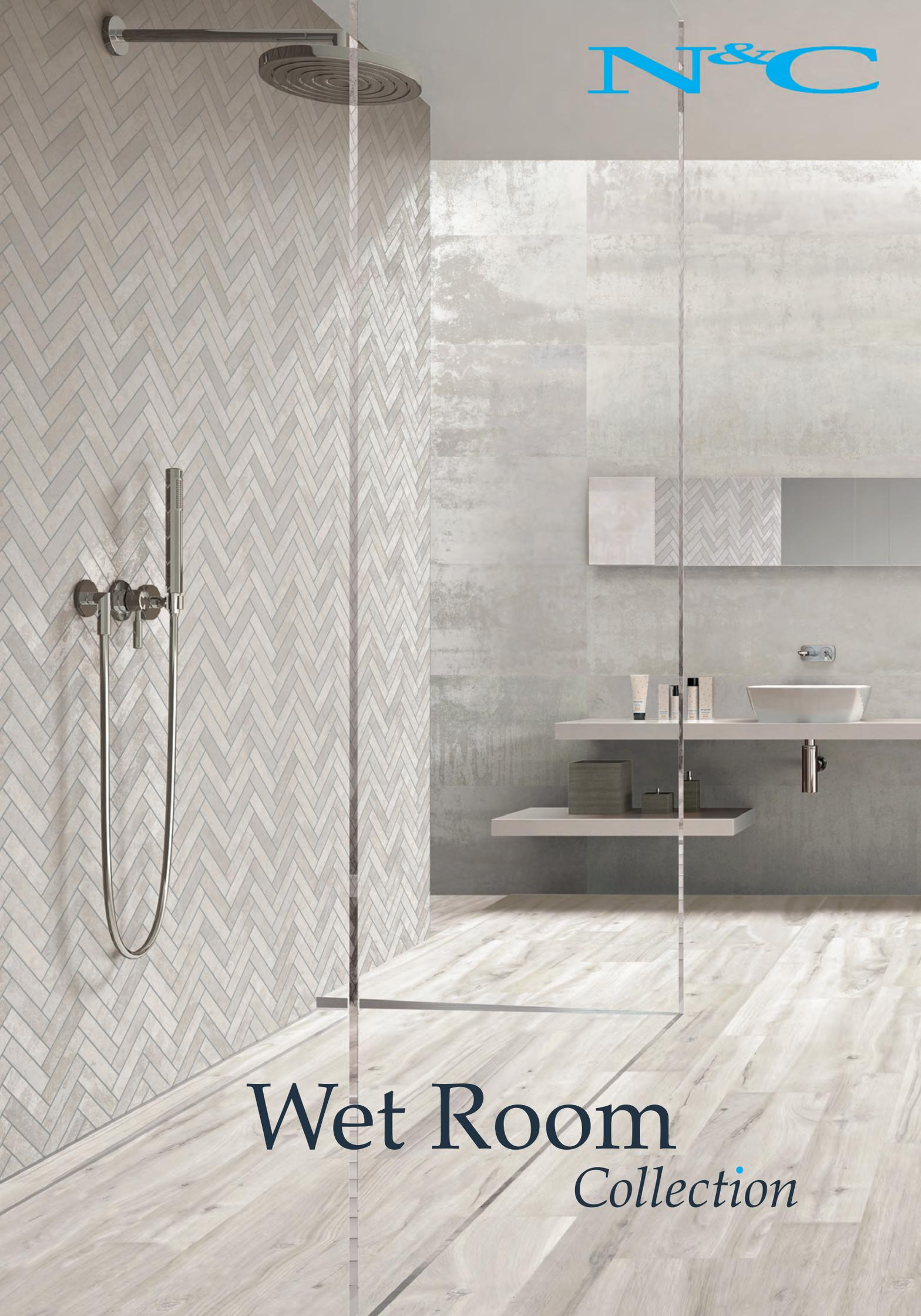

The logo for N&C, featuring the letters 'N' and 'C' in a bold, blue, sans-serif font, with an ampersand between them.A modern bathroom interior featuring a glass shower enclosure with a wall of herringbone-patterned tiles. The shower fixtures are chrome. The rest of the bathroom has large, light-colored stone tiles on the walls and a light wood-look floor. A white vessel sink is on a floating vanity with a chrome faucet. A mirror is mounted above the sink, and a shelf holds various toiletries.

Wet Room
Collection

The Authority on Wet Rooms within the UK

Nicholls & Clarke are experienced, quality manufacturers of the complete wet room system. With over 30 years of experience within the wetroom market, today we offer a comprehensive collection of wet room products that have been developed with the needs of today's market in mind, designed to suit all tastes and requirements.

A luxury addition to any home, hotel or leisure space, a wet room offers attractive, level access showering with the freedom of space and movement. With the endless screen configurations to suit different spaces, opt for the complete N&C wet room system for peace of mind and flexibility in design.

Our wet room components are approved and tested to BS/EN Standards and other regulatory requirements. Furthermore, our exceptional product warranties reflect the stringent test procedures in order to pass our quality checks. We continuously deliver quality products, as standard, to all of our customers.

Nicholls & Clarke
— Est 1875 —

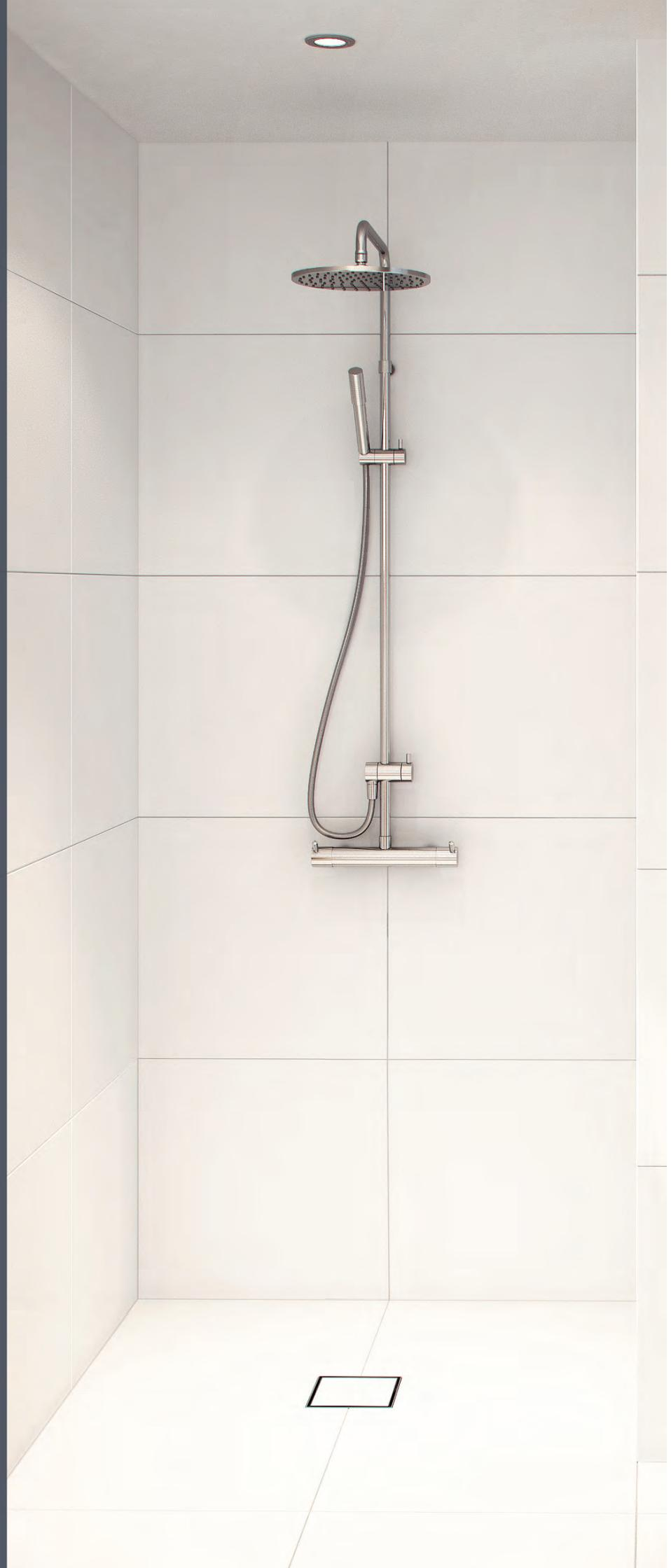

Contents

Introduction

Specialist Manufacturers of the Wet Room System	4 - 5
Why Choose an N&C Wet Room	6 - 7
Wet Rooms Tailored to Your Space	8 - 9

Choose your Complete Wet Room

Shower Decks	12 - 13
Premier Infinity Shower Deck	14 - 17
Premier Shower Deck	18 - 21
Premier Shower Deck Drainage	22 - 25
Aqua-floor Shower Deck	26 - 28
Aqua-floor Shower Deck Drainage	29 - 30
N&C Wet Zone	29
Phlexiknife	29
Phleximax 50 Support Leg	29
Gulleys for Screeded Floors	30
Independent Performance Testing	31

Tanking System

Nicobond Tile Backer Board	34
Nicobond Pipe Covers	34
Nicobond Wet Room Tanking	34
Nicobond PlasticPly™	34
Nicobond Undertile Heating	35
Nicobond Thermostats	35

Wet Room Screen/Panels

Fluidity	38 - 41
Enhance	42 - 43
Silhouette	44 - 45
Finesse Two	46 - 48
Finesse Two Reflex	49
Freespace Two	50 - 53
Creative	54 - 56
Creative Reflex	57

Tiles

Progress	58
Future Stone	59
Surface	59
Diverse Slate	59
Cityscape	60
Wood Spirit	60
Time	61



Specialist Manufacturers of the Wet Room System

N&C are UK manufacturers of the complete wet room system, specialising in the production of high quality, robust products that together create a watertight, proven system for domestic and commercial environments.

Using the latest manufacturing techniques, cutting edge design, the highest quality raw materials and thorough testing procedures, we are proud to have been manufacturing for decades the UK's strongest shower decks, which have achieved industry leading, independent test results.

Our wet room system has been installed in thousands of properties throughout the UK and internationally due to its robust construction, ease of installation, as well as the confidence instilled in our clients through its unfaltering reputation.

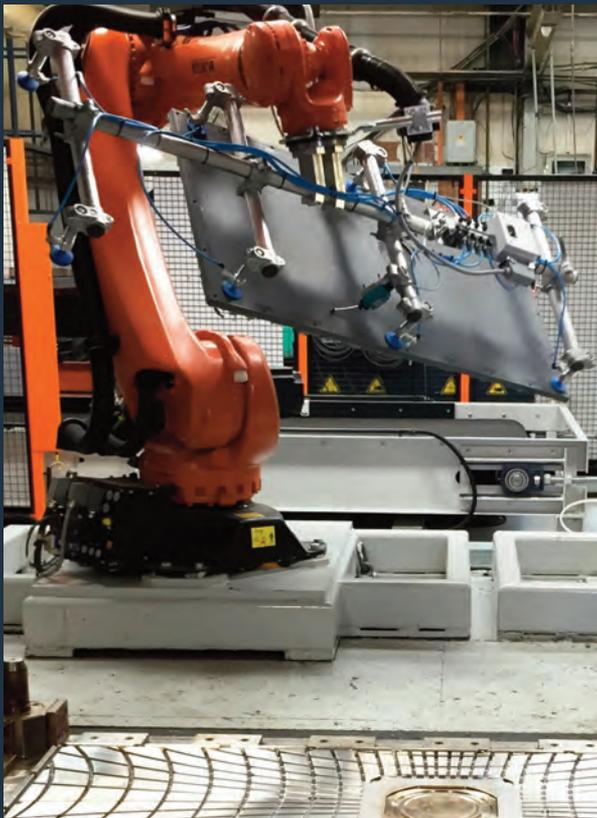







Why Choose an N&C Wet Room

A wet room is a fully tiled shower area that uses a floor former that sits flush with your sub floor, rather than a shower tray that sits on top. A wet room is an attractive bathroom option that is easy to clean, allows freedom of movement, accessibility and flexibility in design. It instantly upgrades the value of your property and is a great way to get a luxury boutique look.

At N&C, we offer a wide range of attractive wet room options which are stylish and affordable. With a broad collection of high quality, innovative wet room screens with unique functionality encompassed within each option, let N&C guide you to creating the perfect wet room.



Wet Rooms Tailored to Your Space

A wet room is ideal for many environments and spaces, whether you are looking at building a luxury ensuite, converting a small domestic cloakroom, renovating a period property bathroom or refurbishing a high usage commercial washroom.

Wet rooms by nature enable a seamless step free transition from the bathroom to the wet area so are accessible by all, making them inclusive in design. Wet rooms are the perfect option for future proofing a home to make the life and investment of a bathroom stretch further.



Small Spaces

Our wet rooms can fit any space, with floor formers as small as 900 x 900mm, which can be further trimmed onsite, with wet room screens to suit. Perfect for those cosy bathroom spaces.

Our wet rooms can be easily installed anywhere, from a ground floor space to a loft conversion. Designed with installation in mind, each component has been carefully manufactured to make installation easier, faster and most importantly, through its design, gives confidence to installers.

Furthermore, with our endless wet room screen ranges and configurations, our wet rooms work around your space, whether you want a wet room to fit into an alcove, a corner, or be freestanding in the centre of the room.

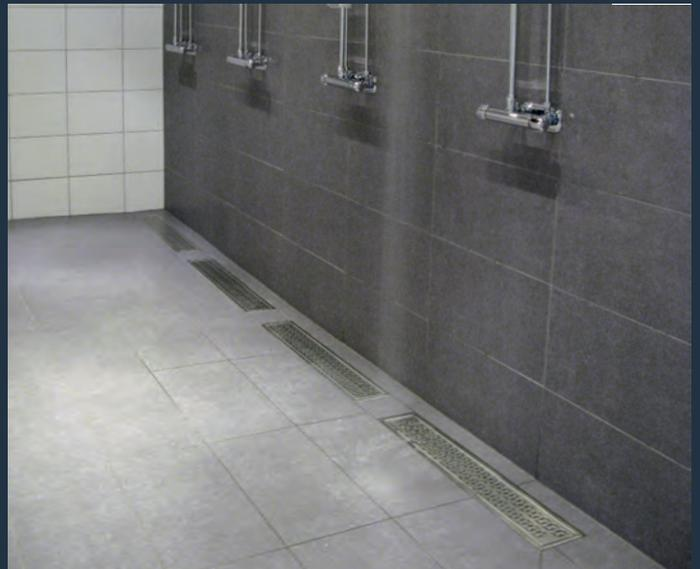

Commercial Spaces

Wet rooms are easy to clean spaces that reduce cleaning time. Opt for a linear drainage option for fast waste extraction.



Boutique Hotel

With N&C wet rooms, hotel owners can create the ultimate on-trend boudoir for visitors. Opt for our attractive Fluidity range of wet room screens with a unique soft close mechanism and a minimalist appearance.



Assisted Spaces

N&C are unique in offering independent living solutions where assistance is required. We offer stylish, practical wet room options for loved ones who require assistance. Perfect for care homes.



Luxury Spaces

A wet room by nature adds optimum elegance to any project. Incorporate our curved wet room screen for a unique appearance guaranteed to impress. Or, why not use one of our reflex wet room screen options that adds a luxury mirrored effect to your screen, whilst instantly increasing the perceived space of the room and offering privacy during showering.

Shower Deck

Choose a suitable shower deck based on the environment and whether the floor covering will be tiled or vinyl installation for a totally water tight solution. Suitable for both concrete and timber floor installations.

Drainage

Choose the suitable drainage system, whether standard or linear, with relevant waste system for the chosen deck.

Wet Room Tanking

Use Nicobond Wet Room Waterproofing Membrane, Tanking Sheet and other components to create a water tight wet room environment.

Nicobond Subfloor Preparation

Use high quality Nicobond manufactured products to prepare the substrate for tiling onto.

Shower Screens

Choose from a vast selection of configurations and attractive screen types suitable for your wet room space.

Tiles & Accessories

Select your preferred wall tiles, floor tiles and shower fittings.





Choose your Complete Wet Room System for Total Confidence

A wet room can be built up using 5 easy steps. Simply select the options that are suited to your wet room environment and usage.

1

Shower Deck

2

Drainage Option

3

Tanking System & Sub Floor Preparation

4

Shower Screen Type & Configuration

5

Tiles and Accessories

1

Shower Decks

Our shower decks have been manufactured to a high quality and independently tested and have been proven to be the strongest shower decks in the UK market. Our decks help to achieve level access showering for a seamless transition into the shower area.

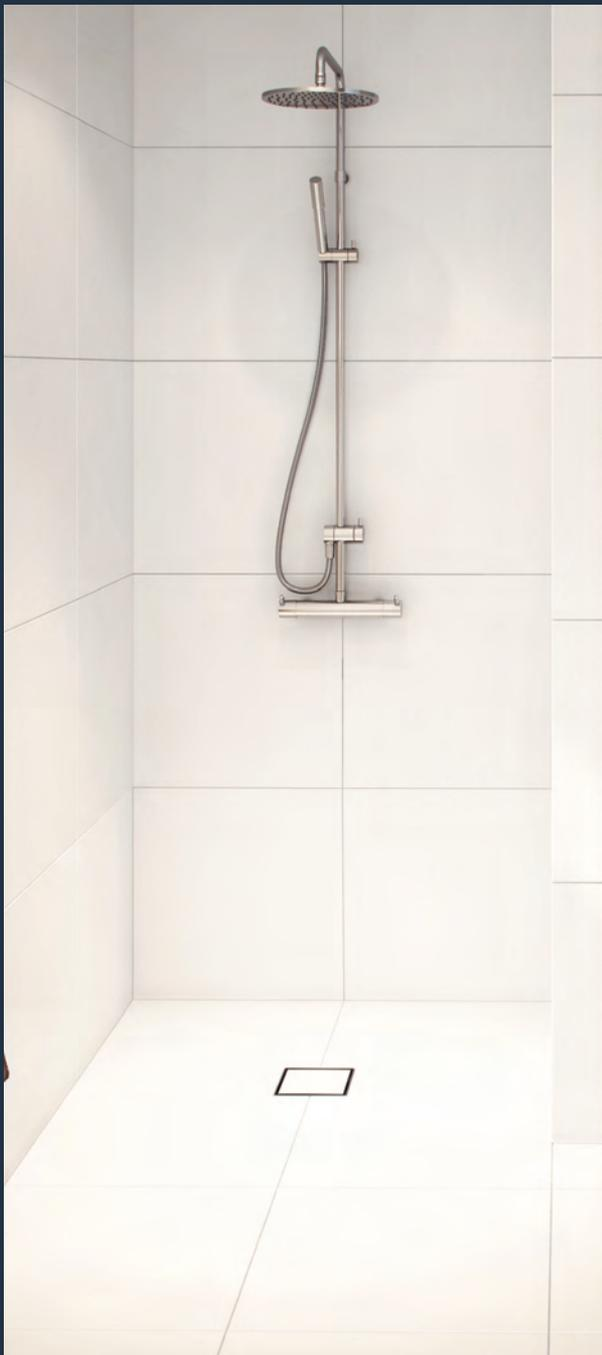

Premier Infinity Shower Deck

Our N&C Premier Infinity Deck is a revolutionary wet room floor former with a unique slider drain system for creating an easy to install, visually appealing level access wet floor. designed with the installer and end user in mind.

The unique, patented, factory-fitted waste outlet can be moved along by the installer to align the waste in the correct position for easy, fuss free installation. The deck also accepts up to 470kg loading and encompasses built in falls, complemented by geometric satin stainless steel edge, for the swift removal of water.

The deck features against-the-wall drainage that helps to achieve an invisible, seamless system that is discreet and attractive.



Level Access



Factory Fitted Linear Waste



Recycled Content



Bed into Wood



Bed into Concrete



Use with Tiles

- Factory fitted waste outlet for total confidence of a leak free connection
- Sliding action waste to avoid timber joists
- Invisible waste system that is unobtrusive
- Tile insert for discreet waste appearance
- Precision engineered single direction gradients
- Manufactured using high strength precision metal moulds
- Strong and durable base made from 50% recycled material
- Built-in 12.5mm upstand
- Can be tiled directly onto
- Built in gradients for water removal to the waste
- Pilot holes for easier installation
- Ideal for total level access
- Accepts over 470kg loading
- 28mm level access base

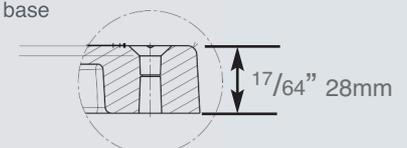



Premier Shower Deck

Premier Shower Deck is ideal for creating a level access wet floor area with ease. With a self supporting structure, Premier Shower Deck can be placed directly onto underfloor joists without the need for additional support. The built-in falls in the deck encourage the swift removal of waste water.

Designed with easy installation in mind, Premier Shower Decks can be installed into existing concrete or timber floors. Offset waste outlets have been designed to avoid joists (in most circumstances) for easier access to the pipework. The pre-cut outlet is suitable for use with gravity waste or pumped waste systems. Pre-cut linear drainage options are also available.









Level Access



Offset Waste



Cut to Length



Recycled Content



100% Recyclable



Bed into Wood



Bed into Concrete



Use with Tiles



Use with Vinyl

- Manufactured using high strength precision metal moulds
- Strong and durable base made from 50% recycled material
- Ideal for tiling directly onto or can be covered in vinyl
- Precision engineered gradients and slopes
- Ideal for total level access
- Waste offset to avoid joists
- Pre-cut waste outlet suitable for gravity waste or pumped waste systems
- Self supporting, no requirement for additional support
- Unique resin compound formulation
- Linear and round drainage options
- Can be trimmed on site
- Accepts over 470kg loading
- 22mm level access base

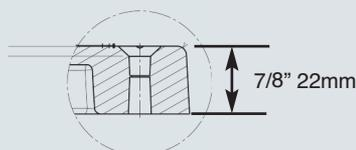

Aqua-floor Shower Deck

Our Aqua-floor shower decks have been compression moulded using a high glass content SMC formulation.

Computer Aided Modelling was used to create this unique, ribbed design to the underside of the Aqua-floor. Independent tests prove Aqua-floor's structural cellular design enables us to achieve the highest levels of durability and strength of SMC floor formers on the market, with minimal deflection.

At 350kg point loading, Aqua-floor offers complete confidence in its rigidity and strength.









Level Access



Offset Waste



Cut to Length



Recycled Content



100% Recyclable



Bed into Wood



Bed into Concrete



Use with Vinyl

- Market leading strength and rigidity
- Accepts 55 Stone / 350kg of loading
- Unique high grade SMC formulation
- Computer aided cellular structure design
- Suitable for timber / joist installation
- Beds well into concrete / screed substrates
- Unique cross linked rib design for optimum strength
- No under boarding required
- 22mm level access base
- Pre formed fixing holes
- Drill guideline - if additional fixing points are required
- Precision engineered gradients / slopes
- Pre-cut waste outlet suitable for gravity waste or pumped waste systems
- Waste offset to avoid joists
- Can be trimmed on site

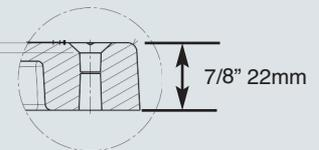

Premier Infinity Shower Deck

Unique waterproof revolutionary factory fitted sliding drain system. Experience Luxury with the Invisible Infinity Deck System



A unique, sliding drain system with an integrated factory fitted waste for complete confidence

- Factory fitted waste outlet for total confidence of a leak free connection
- Moveable waste to avoid joists in the floor during installation
- Against the wall invisible drainage system that allows for a seamless, unobtrusive water removal
- Comes with a drain insert that can be tiled
- Manufactured using high strength precision metal moulds
- Strong and durable base made from 50% recycled material
- Built-in 12.5mm upstand
- Can be tiled directly on to
- Avoid envelope cutting of tiles as system uses single, gradual slope
- Built in gradients for water removal to the waste
- Ideal for total level access
- Self supporting, no requirement for additional support
- Accepts 470kg point loading
- 28mm level access base

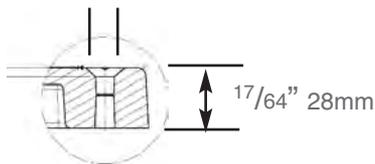

With threaded waste outlet 38mm



Slideable waste, up to 175mm, to avoid joists



Invisible drainage system



Level Access



Factory Fitted Linear Waste



Recycled Content



Bed in to Wood



Bed in to Concrete



Use with Tiles

Our N&C Premier Infinity Deck is a revolutionary shower deck with a unique, factory-fitted waste outlet which can be moved along by the installer to align the waste in the correct position. The sliding action of the outlet means that the deck can be sited in a convenient position where obstacles such as a joist can be avoided.

The deck also features a unique waste removal system, which means that the finished result is an invisible, seamless and highly attractive waste system that is discreet and attractive. The precision engineered single direction gradient, complemented by the stainless steel edge allows for the high volume removal of waste water.

This is a highly innovative approach to linear decks where we offer a practical, attractive and fuss free alternative to other conventional linear drainage systems.



Premier Infinity Shower Decks

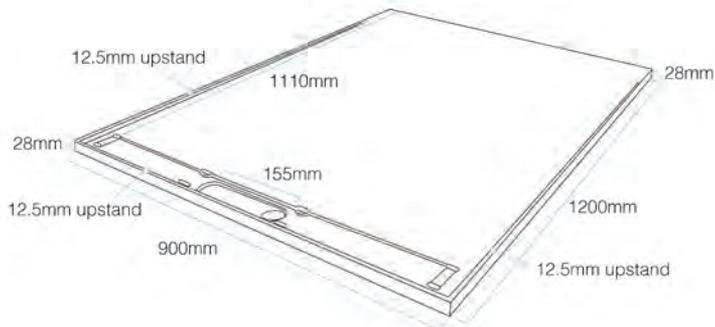

1200 x 900mm Short side waste

P6822008

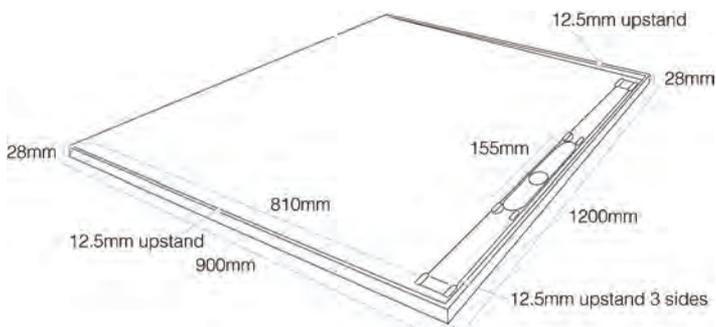

1200 x 900mm Long side waste

P6822007

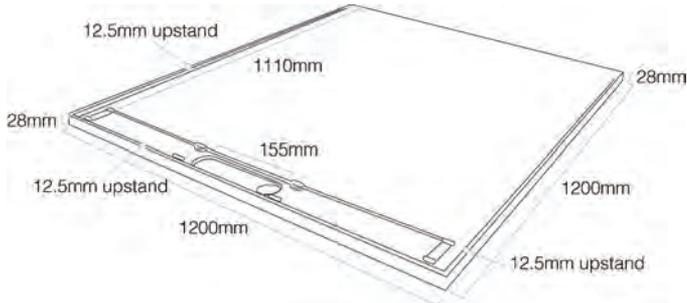

1200 x 1200mm

P6822006



Premier Infinity Tileable Insert Grating

- Stainless Steel
- Tray Type

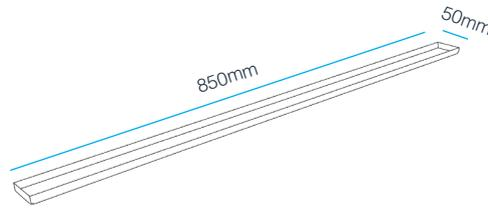

900 x 50 x 10mm	S2220500
900 x 50 x 12mm	S2220502
900 x 50 x 14mm	S2220504

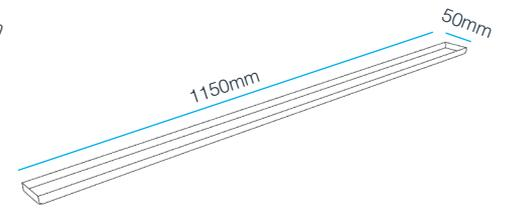

1200 x 50 x 10mm	S2220501
1200 x 50 x 12mm	S2220503
1200 x 50 x 14mm	S2220505



Premier Infinity Tileable Grating

- Stainless Steel
- Flat Plate Type

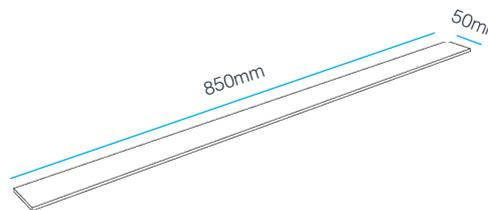

900 x 50 x 4mm	S2220506
----------------	----------

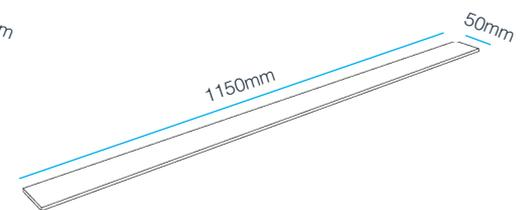

1200 x 50 x 4mm	S2220507
-----------------	----------



Right hand illustrated

Premier Infinity Inclined Shower Profile

- Stainless Steel

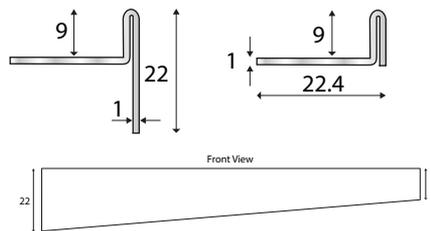

Right Hand	9mm - 900mm (889mm)	S2220520
Left Hand	9mm - 900mm (889mm)	S2220522

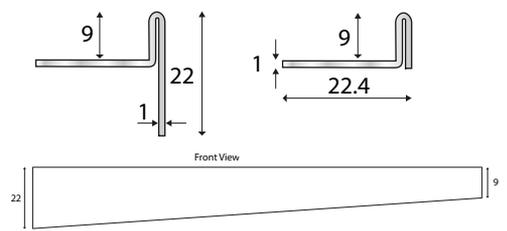

Right Hand	9mm - 1200mm (1189mm)	S2220521
Left Hand	9mm - 1200mm (1189mm)	S2220523

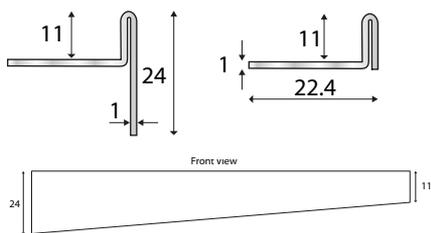

Right Hand	11mm - 900mm (889mm)	S2220524
Left Hand	11mm - 900mm (889mm)	S2220526

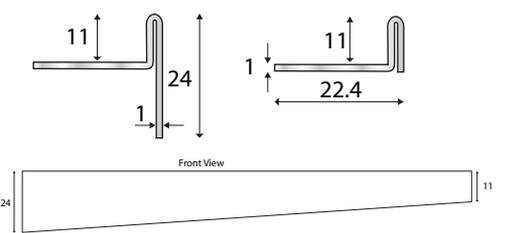

Right Hand	11mm - 1200mm (1189mm)	S2220525
Left Hand	11mm - 1200mm (1189mm)	S2220527



Premier Infinity Trap System

- 50mm water seal
- 100mm overall depth
- 22 ltr per minute flow rate
- supplied complete with 95° & straight 38mm multi-fit pipe connectors

Trap System	S2370509
-------------	----------

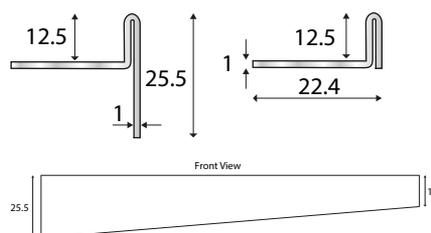

Right Hand	12.5mm - 900mm (889mm)	S2220528
Left Hand	12.5mm - 900mm (889mm)	S2220530

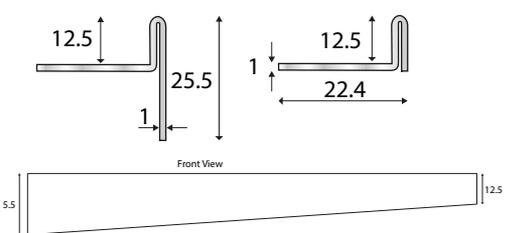

Right Hand	12.5mm - 1200mm(1189mm)	S2220529
Left Hand	12.5mm - 1200mm(1189mm)	S2220531

Premier Shower Deck

Our Premier Shower Deck is a robust, self supporting solution for achieving a total level access wet floor showering area with confidence. Tried and tested, the Premier Shower Deck is manufactured to high quality performance and endurance.



The versatile and robust, self supporting shower deck accepting up to 470kg

- The UK's strongest shower deck
- Manufactured using high strength precision metal moulds
- Strong and durable base made from 50% recycled material
- Ideal for tiling directly onto or can be covered in vinyl
- Precision engineered gradients and slopes
- Ideal for total level access
- Waste offset to avoid joists
- Self supporting, no requirement for additional support
- Unique resin compound formulation
- Linear and round drainage options
- Can be trimmed on site
- Accepts over 470kg loading
- 22mm level access base
- Solid construction

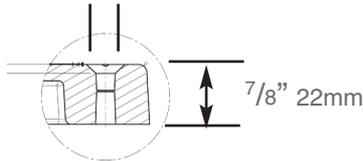

Level Access



Offset Waste



Cut to Length



Recycled Content



100% Recyclable



Bed in to Wood



Bed in to Concrete



Use with Tiles



Use with Vinyl

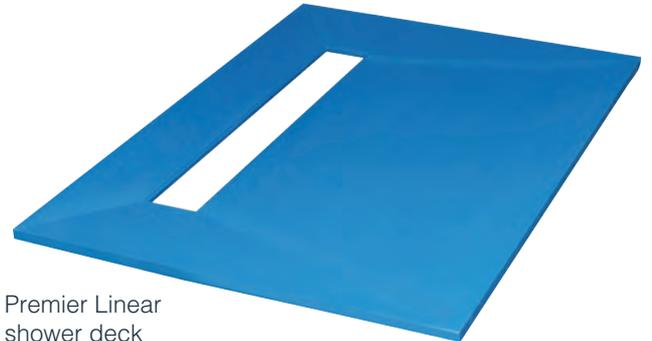

Premier Shower Deck is ideal for creating a level access wet floor area with ease. With a self supporting structure, Premier Shower Deck can be placed directly onto underfloor joists without the need for additional support. The built-in falls in the deck encourages the swift removal of waste water.

Designed with easy installation in mind, Premier Shower Decks can be installed into existing concrete or timber floors. Offset waste outlets have been designed to avoid joists (in most circumstances) for easier access to the pipework. The pre-cut outlet is suitable for use with gravity waste or pumped waste systems. Pre-cut linear drainage options are also available.

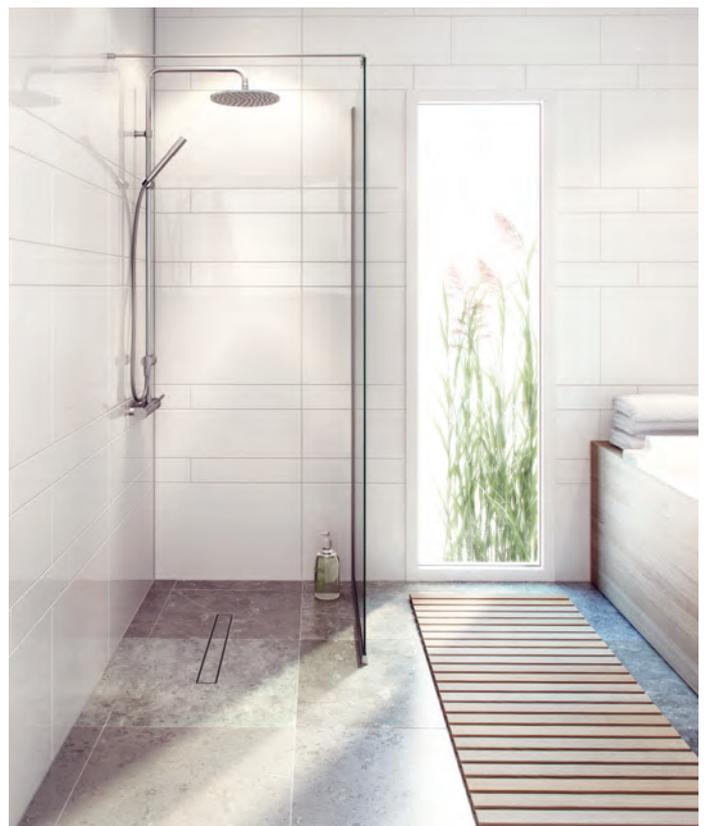

Premier Shower Decks

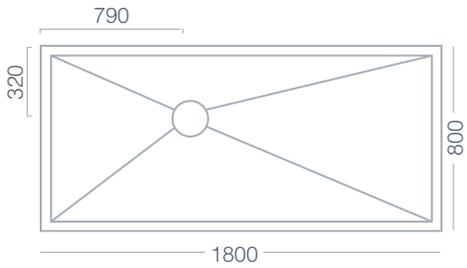

1800 x 800mm P6821940

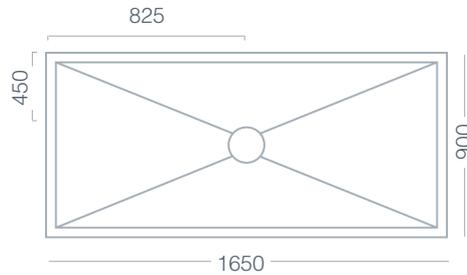

1650 x 900mm P6821942

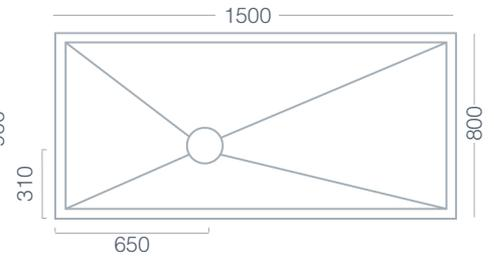

1500 x 800mm P6821933

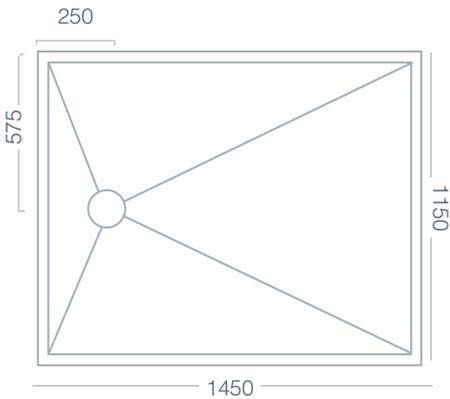

1450 x 1150mm P6821929

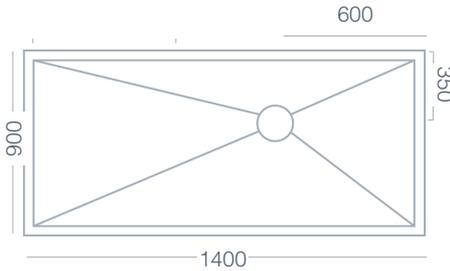

1400 x 900mm P6821935

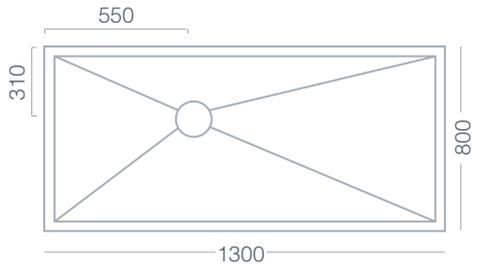

1300 x 800mm P6821932

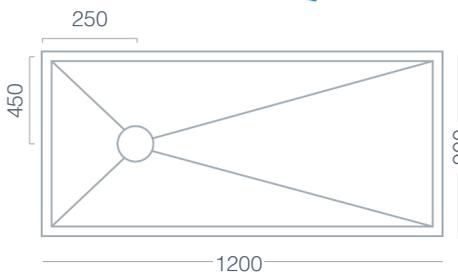

1200 x 900mm P6821943

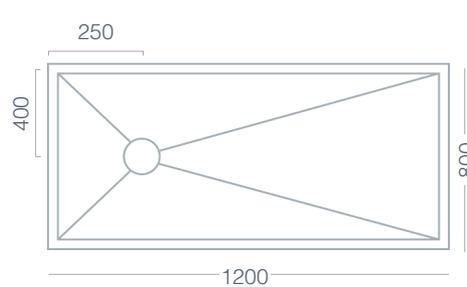

1200 x 800mm P6821941

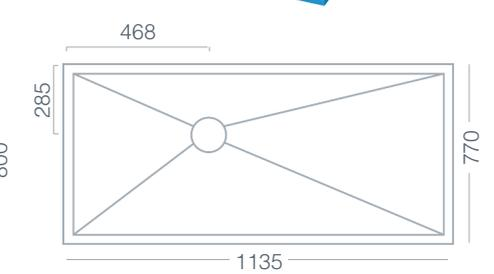

1135 x 770mm P6821931

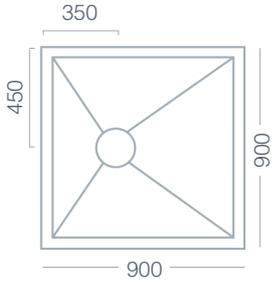

900 x 900mm

P6821934

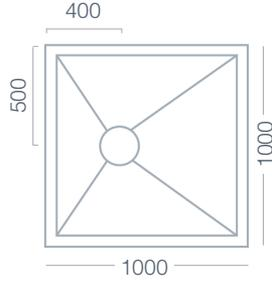

1000 x 1000mm

P6821930

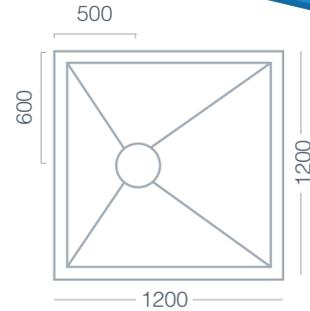

1200 x 1200mm

P6821936

Premier Linear Shower Decks

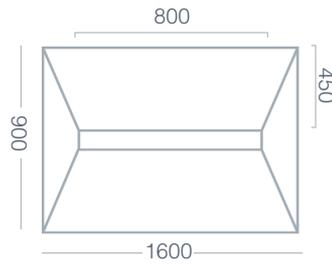
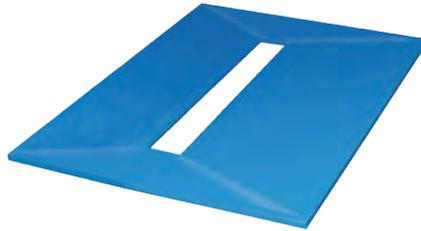

1600 x 900mm

P6821986

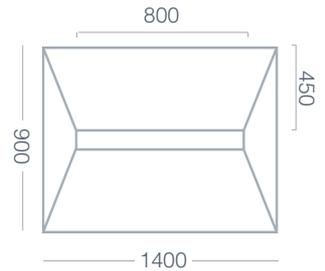

1400 x 900mm

P6821985

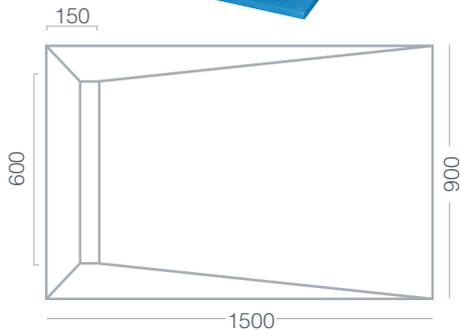

1500 x 900mm

P6821989

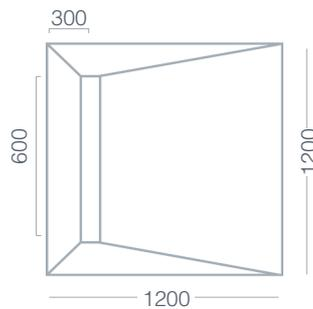

1200 x 1200mm

P6821987

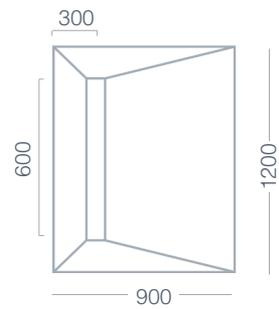
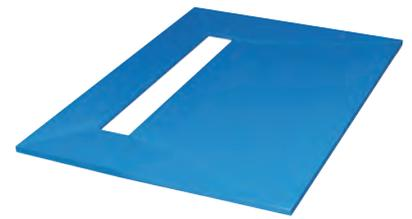

1200 x 900mm

P6821988

Premier Shower Deck - Drainage for tiles floors

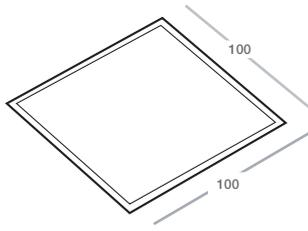

Phleximax Tile Shower Drain Assembly

- 100 x 100mm
- Adjustable for tile thickness 6mm - 26mm



Satin Stainless Steel P6882550



Polished Stainless Steel P6882551



Bronze P6882552



Gravity Waste Traps for Phleximax Tile Shower Drain Assembly

- 90mm Trap
- 38mm outlet
- Flow rate of 34 litres per minute
- 50mm water seal



Gravity Waste Trap

Shallow waste S2220183



Shallow Waste for pump waste system

Shallow waste P6821631

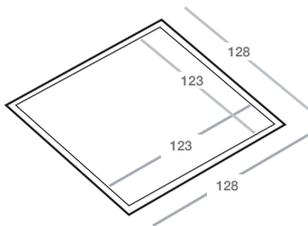

Phleximax 50 grating for tiled floor

- 128 x 128mm



Phleximax 50 tile frame tile insert

- Chrome

Tile P6882472



Phleximax 50 tile frame twist insert

- Chrome

Twist P6882473



Phleximax 50 tile frame platinum insert

- Chrome

Platinum P6882474

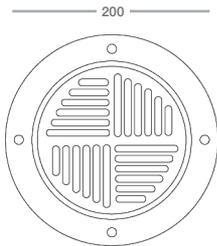

Phleximax 50 shower gully for vinyl floors

- Flow rate 48 ltrs per minute
- Supplied complete with adapter
- NOOD no-odour water trap
- Mechanical trap



Phleximax 50 shower gully

- White

Gully P6882441



Phleximax 50 vertical shower gully

- White

Gully P6882398



Phleximax 50 two part shower gully

- Grey

Gully P6882471



Drop



Twist



Tile Insert



**Phlexiline Living
50mm standard side outlet**

- ABS 1 1/2 inch adapter
- Concrete & joist installation kits
- Flow rate 60 litres per minute

600mm	Drop	P6882500
800mm	Drop	P6882510



**Phlexiline Living
50mm low mini outlet**

- ABS 1 1/2 inch adapter
- Concrete & joist installation kits
- Flow rate 30 litres per minute

600mm	Drop	P6882503
800mm	Drop	P6882513



**Phlexiline Living
50mm side/side outlet**

- ABS 1 1/2 inch adapter
- Concrete & joist installation kits
- Flow rate 60 litres per minute

600mm	Drop	P6882506
800mm	Drop	P6882516



**Phlexiline Living
50mm standard side outlet**

- ABS 1 1/2 inch adapter
- Concrete & joist installation kits
- Flow rate 60 litres per minute

600mm	Twist	P6882501
800mm	Twist	P6882511



**Phlexiline Living
50mm low mini outlet**

- ABS 1 1/2 inch adapter
- Concrete & joist installation kits
- Flow rate 30 litres per minute

600mm	Twist	P6882504
800mm	Twist	P6882514



**Phlexiline Living
50mm side/side outlet**

- ABS 1 1/2 inch adapter
- Concrete & joist installation kits
- Flow rate 60 litres per minute

600mm	Twist	P6882507
800mm	Twist	P6882517



**Phlexiline Living
50mm standard side outlet**

- ABS 1 1/2 inch adapter
- Concrete & joist installation kits
- Flow rate 60 litres per minute

600mm	Tile	P6882502
800mm	Tile	P6882512



**Phlexiline Living
50mm low mini outlet**

- ABS 1 1/2 inch adapter
- Concrete & joist installation kits
- Flow rate 30 litres per minute

600mm	Tile	P6882505
800mm	Tile	P6882515



**Phlexiline Living
50mm side/side outlet**

- ABS 1 1/2 inch adapter
- Concrete & joist installation kits
- Flow rate 60 litres per minute

600mm	Tile	P6882508
800mm	Tile	P6882518



**Phlexiline Living
50mm bottom outlet gully**

- Includes tile grate & install kit
- Flow rate 72 litres per minute
- Concrete & joist installation kits

600mm	Tile	P6882395
800mm	Tile	P6882392

Premier Shower Deck - Drainage for vinyl floors

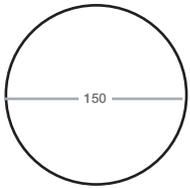

Phleximax Grating for vinyl floors

- 150mm Diameter



Wave	P6882453
------	----------



Drop	P6882452
------	----------



Art Deco	P6882451
----------	----------

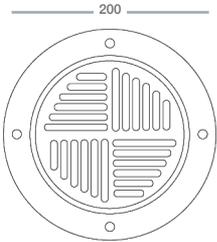

Phleximax 50 shower gully for vinyl floors

- Flow rate 48 ltrs per minute
- Supplied complete with adapter
- NOOD no-odour water trap
- Mechanical trap



Phleximax 50 shower gully

- White

Gully	P6882441
-------	----------



Phleximax 50 vertical shower gully

- White

Gully	P6882398
-------	----------



Phleximax 50 two part shower gully

- Grey

Gully	P6882471
-------	----------



Phlexiline Living Plus standard side outlet

- For vinyl floors
- Stainless steel grate
- 50mm outlet with ABS 1 1/2 inch adapter
- Flow rate 60ltrs per minute

600mm	Chessgrate	P6882521
800mm	Chessgrate	P6882524



Phlexiline Living Plus low outlet

- For vinyl floors
- Stainless steel grate
- 50mm outlet with ABS 1 1/2 inch adapter
- Flow rate 30ltrs per minute

600mm	Chessgrate	P6882522
800mm	Chessgrate	P6882525



Phlexiline Living Plus side/side outlet

- For vinyl floors
- Stainless steel grate
- 50mm outlet with ABS 1 1/2 inch adapter
- Flow rate 60ltrs per minute

600mm	Chessgrate	P6882523
800mm	Chessgrate	P6882526



Aqua-floor Shower Deck

Aqua-floor is an innovative shower deck with a unique cellular structure which makes it the most robust and strongest shower deck for vinyl installations.

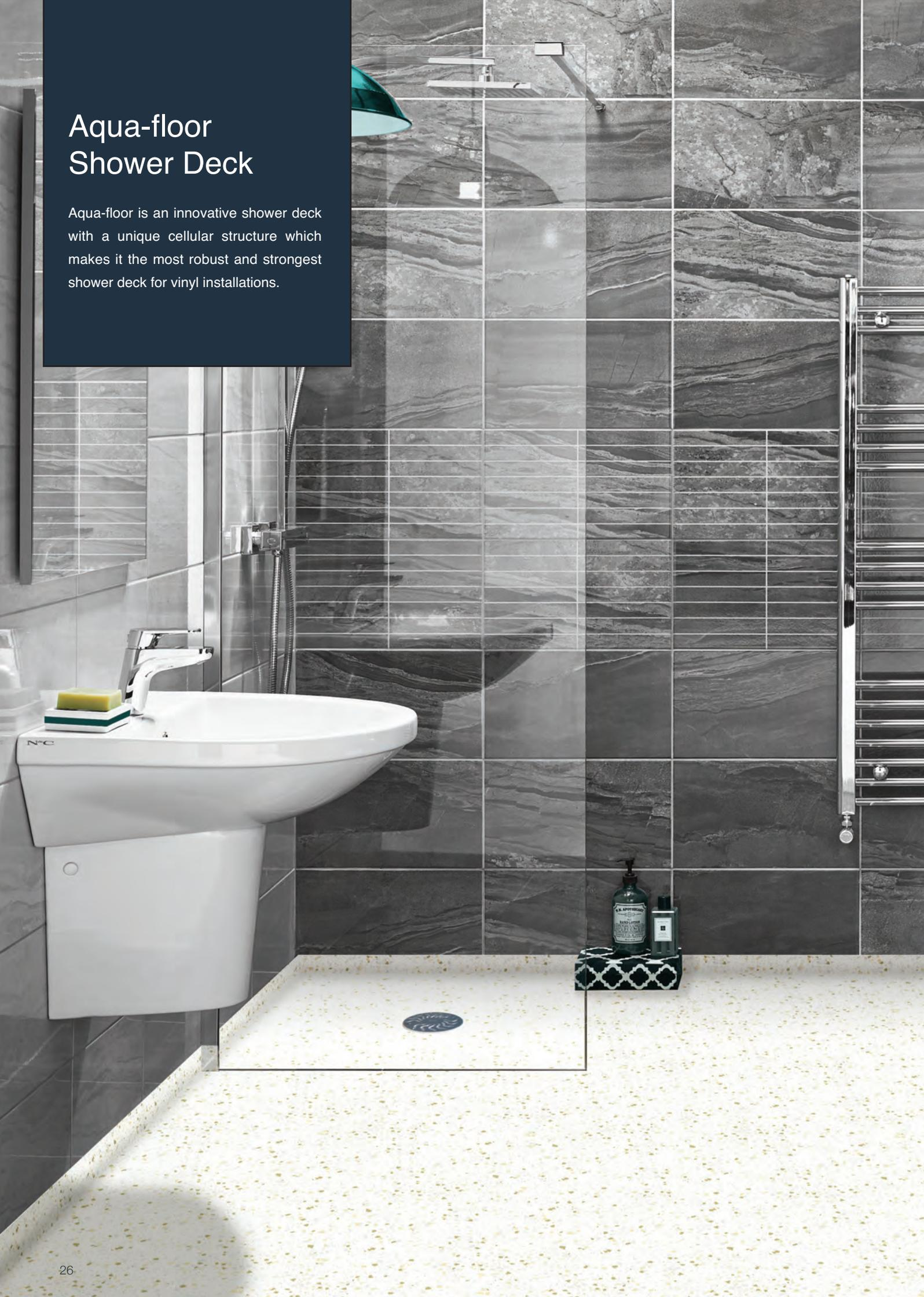

The strongest SMC deck with a unique ribbed underside, perfect for vinyl installations

- Market leading strength and rigidity
- Accepts 55 Stone / 350kg of loading
- Unique high grade SMC formulation
- Computer aided cellular structure design
- Suitable for timber / joist installation
- Beds well into concrete / screed substrates
- Unique cross linked rib design for optimum strength
- No under boarding required
- 22mm level access base
- Pre formed fixing holes
- Drill guideline - if additional fixing points are required
- Precision engineered gradients / slopes
- Waste offset to avoid joists
- Can be trimmed on site
- 100% recyclable
- Excellent stock availability throughout the UK

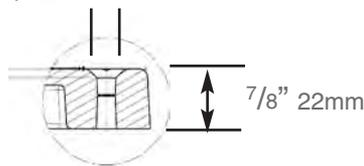

Level Access



Offset Waste



Cut to Length



Recycled Content



100% Recyclable



Bed in to Wood



Bed in to Concrete



Use with Vinyl

The N&C Aqua-Floor shower deck is a high strength wet room shower deck that has been compression moulded using a high glass content SMC formulation.

Computer Aided Modelling was used to create this unique, ribbed design to the underside of the Aqua-floor. Independent tests prove Aqua-floor's structural cellular design enables us to achieve the highest levels of durability and strength of SMC floor formers on the market, with minimal deflection. At 350kg point loading, Aqua-floor offers complete confidence in its rigidity and strength.



Aqua-floor - Shower Decks

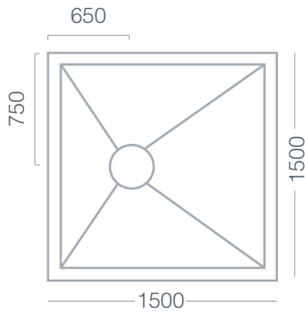

1500 x 1500mm P6820430

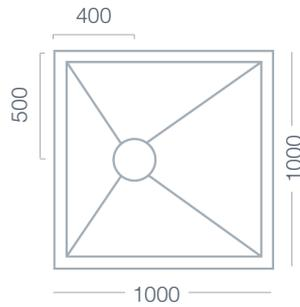

1000 x 1000mm P6820432

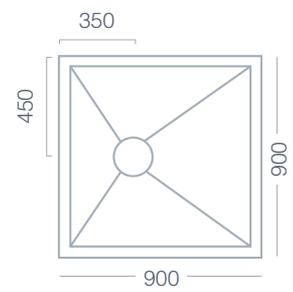

900 x 900mm P6820431

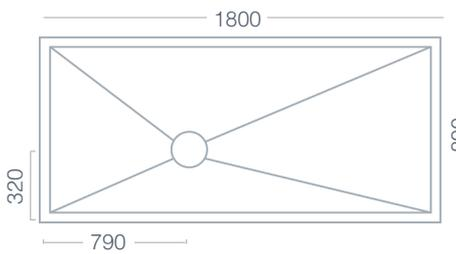

1800 x 800mm P6820437

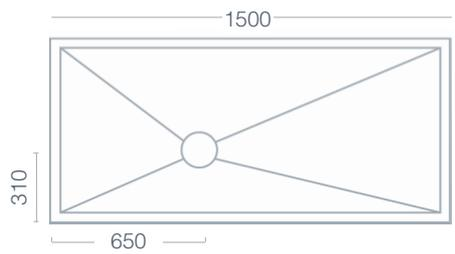

1500 x 800mm P6820436

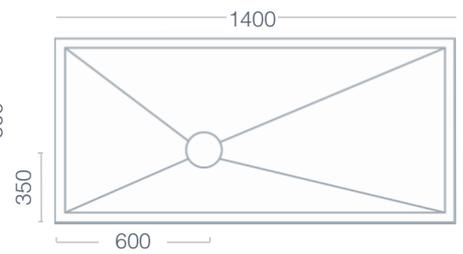

1400 x 900mm P6820435

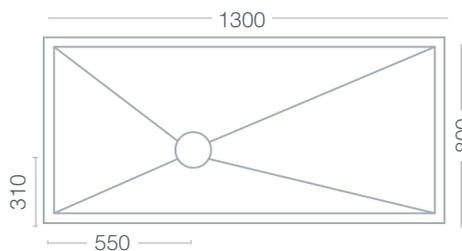

1300 x 800mm P6820434

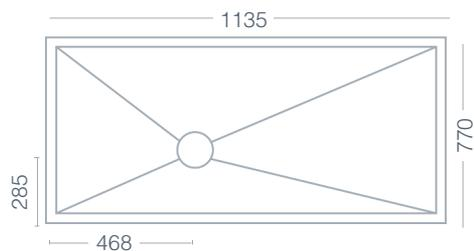

1135 x 770mm P6820433

Aqua-floor Shower Deck - Drainage for vinyl floors

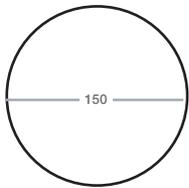

Phleximax Grating for vinyl floors

- 150mm Diameter



Wave P6882453



Drop P6882452



Art Deco P6882451

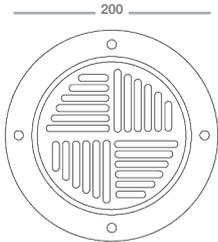

Phleximax 50 shower gully for vinyl floors

- Flow rate 48 ltrs per minute
- Supplied complete with adapter
- NOOD no-odour water trap
- Mechanical trap

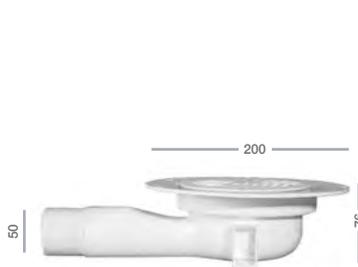

Phleximax 50 shower gully

- White

Gully P6882441



Phleximax 50 vertical shower gully

- White

Gully P6882398



Phleximax 50 two part shower gully

- Grey

Gully P6882471



Vinyl Form Shower Gully

- Flow rate of 48 litres per minute
- 50mm water seal

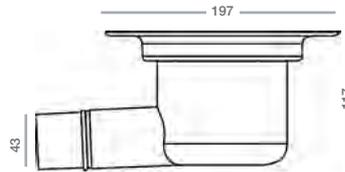

Shower Gully P6820599

N&C Wet Zone

Our N&C Wet Zone is quickly and easily assembled using the N&C Premier Shower Deck mounted onto the Wet Zone Base. The principle benefit being that the components sit directly onto the floor. This offers the perfect solution where it is impossible or impractical to breach the floor. Waste pipes and connections are all built in to the base and previous connections can be utilised. A shower screen, tiles and shower valve complete the transformation.



N&C Wet Zone for use with Premier Shower Deck (not included)

1000 x 1000 x 105mm (for use with P6821930)	N2561000
1500 x 800 x 105mm (for use with P6821933)	N2561500

Phlexiknife

A tool for the professional craftsman when connecting a vinyl floor or tanking system to the Phleximax floor gully. P6882441

When using the waterproof pipe collar this tool should be used to cut the perfect circle for securing into the Phleximax gully system, alternatively it can be used for cutting vinyl prior to securing into the Phleximax 50.



Phlexiknife P6882445

Phleximax 50 Support Leg

Support leg for Phleximax 50 for concrete installations for linear drains.

Water Trap Phleximax	P6882444
Phlexi Plate 130	P6882446
Clamping Ring 130	P6882447
Locking Screws for Plastic Grating	P6882448
Locking Screws for Stainless Grating	P6882449
Phleximax Vinyl Grating	P6882450
Extension 130mm Gullies 13mm	P6882454
Extension 130mm Gullies 25mm	P6882455



Support Leg P6882396

Phlexiline Linear Gulleys - for tiles screed floors



Phlexiline Living 50mm low mini outlet

- ABS 1 1/2 inch adapter
- Concrete & joist installation kits
- Flow rate 30 litres per minute

600mm	Drop	P6882503
800mm	Drop	P6882513



Phlexiline Living 50mm low mini outlet

- ABS 1 1/2 inch adapter
- Concrete & joist installation kits
- Flow rate 30 litres per minute

600mm	Twist	P6882504
800mm	Twist	P6882514



Phlexiline Living 50mm low mini outlet

- ABS 1 1/2 inch adapter
- Concrete & joist installation kits
- Flow rate 30 litres per minute

600mm	Tile	P6882505
800mm	Tile	P6882515

Phlexiline Linear Gulleys - for vinyl screed floors



Phlexiline Living Plus Low Outlet

- For vinyl floors
- Stainless steel grate
- 50mm outlet with ABS 1 1/2 inch adapter
- Flow rate 30ltrs per minute

600mm	Chessgrate	P6882522
800mm	Chessgrate	P6882525

Grates & Waste - for screed floors



Phleximax S-Series 59mm floor gully

- Flow rate 48 litres per minute
- NOOD no-odour water trap
- 50mm to 1 1/2" UK adapter & stainless steel clamping ring

Gully	P6882488
-------	----------

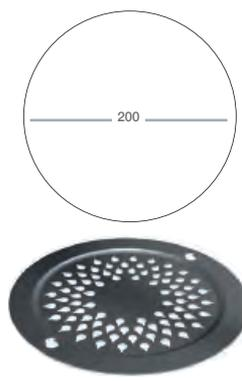

Phleximax Grating for vinyl floor

- 200 x 200mm
- Stainless steel

Drop	P6882489
------	----------

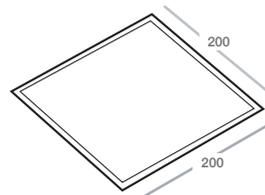

Phleximax Grating for tiled floor

- 200 x 200mm
- Stainless steel

Classic	P6882487
---------	----------

Wave	P6882485
------	----------



Art Deco	P6882484
----------	----------

Drop	P6882486
------	----------



Independent Performance Testing

An Independent expert testing authority, WMG, have completed a full programme of audited testing to evaluate the performance of the N&C Premier Shower Deck and N&C Aqua-floor Shower Deck in comparison with two competitor SMC products. The shower decks were mounted on a bespoke test rig and were subjected to point loading and distributed weight spread loading using a hydraulic cylinder or plate with a calibrated load cell.

The unloaded decks were scanned for reference using an Optical Coordinate Measurement Machine and then re-scanned as increased levels of load were applied. The test report results, shown in graph form, confirms that the N&C Premier Shower Deck was found to outperform all competitor products tested against strict test criteria*.

The report also confirms that the N&C Aqua-floor SMC shower deck outperforms the competitors SMC shower decks tested; offering best in class for point loading and distributed weight spread loading.

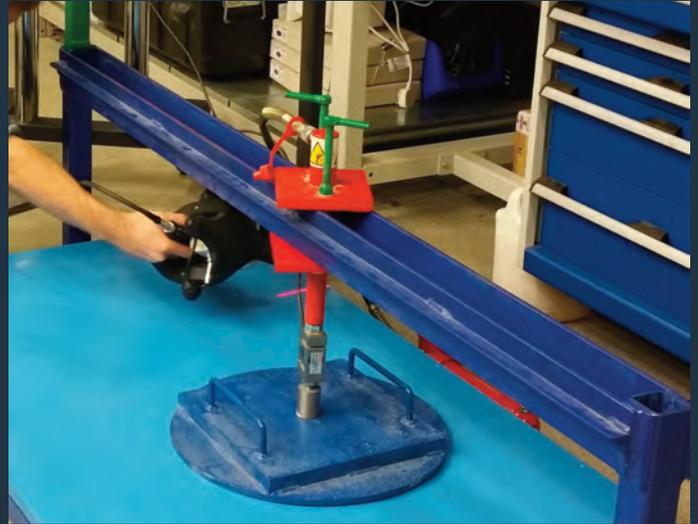

International Manufacturing Centre

Advanced robotic SMC production line.

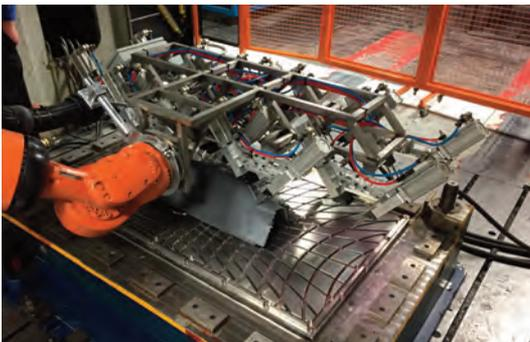

High grade SMC based material being placed in to an Aqua-floor shower deck mould using the UK's most technically advanced robotic SMC production line.



Aqua-floor shower deck being placed on the conveyor belt heading for our packaging line.

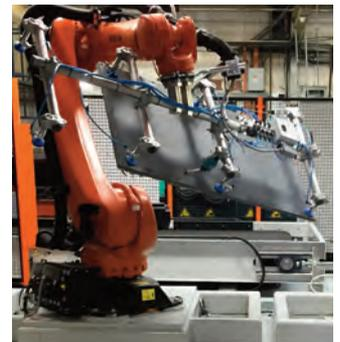

A freshly moulded Aqua-floor Shower Deck ready to be removed from its mould.

Deflection Under Point Loading at 250kg



The Results...

N&C Premier Shower Deck proved to be up to 30% stronger than the competitors decks tested.

N&C Aqua-Floor Shower Deck proved to be up to 20% stronger than the competitors SMC decks tested.



Deflection Under Point Loading at 350kg



The Results...

N&C Premier Shower Deck proved to be up to 30% stronger than the competitors decks tested.

N&C Aqua-Floor Shower Deck proved to be up to 25% stronger than the competitors SMC decks tested.



Deflection Under Point Loading at 250kg



The Results...

N&C Premier Shower Deck proved to be up to 52% stronger than the competitors decks tested.

N&C Aqua-Floor Shower Deck proved to be up to 24% stronger than the competitors SMC decks tested.



Deflection Under Point Loading at 350kg

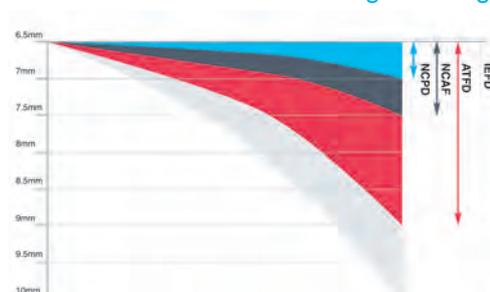

The Results...

N&C Premier Shower Deck proved to be up to 25% stronger than the competitors decks tested.

N&C Aqua-Floor Shower Deck proved to be up to 21% stronger than the competitors SMC decks tested.



*test criteria available on request

3 Tanking System

The N&C Nicobond Wet Room Tanking System is a high performance, water tight and proven system that has been used extensively across the UK. Used by housebuilders of all sizes, our tanking system has been incorporated into thousands of homes throughout the UK.

As specialists in wet rooms for over 30 years, our easy to use wet room tanking system is manufactured with total confidence and with installers in mind.







Nicobond Tile Backer Board

Nicobond Tile Backer Board is a lightweight, insulating and waterproof construction board which is an ideal substrate for a tiled wet room and for undertile heating.

- Water and fire resistant
- Suitable for walls and floors
- Undertile heating and eco friendly

600 x 1200 x 6mm	N2553006
600 x 1200 x 10mm	N2553010
600 x 2400 x 12.5mm	N2553012
600 x 2400 x 20mm	N2553020
600 x 2400 x 30mm	N2553030
600 x 2400 x 40mm	N2553040
600 x 2400 x 50mm	N2553050
600 x 2400 x 60mm	N2553060
600 x 2400 x 70mm	N2553070
2400 x 1200 x 12.5mm	N2553084

Hammer Fixings	70mm	N2553110
Screw Fixings	45mm	N2553112
Screw Fixings	25mm	N2553114
Aluminium Washer	35mm	N2553116
Joining Tape	48 x 45mm	N2552120



Nicobond Pipe Covers

Nicobond Pipe Covers are manufactured from high density extruded polystyrene with a specially formulated reinforced cementitious smooth surface coating. Nicobond Pipe Covers are designed to be placed directly over the pipe routes.

- Perfect fit for soil vent pipes
- Fitted within minutes
- Waterproof and flame retardant
- Ready to tile or paint
- No timber studwork required

140 x 140 x 2400mm	N2553150
200 x 200 x 2400mm	N2553200
200 x 300 x 2400mm	N2553240

Nicobond Wet Room 10m² Self Adhesive Tanking Kit.

A convenient kit providing all the necessary materials to waterproof a wet room area.

- 10mt x 1mtr roll
- 1 Litre primer
- 20mtr x 80mm tape
- 4 x internal corners
- 1 x external corner

Nicobond Wet Room Waterproofing Membrane

A quick drying liquid applied waterproofing membrane for rigid surfaces in wet rooms, that dries to form a highly flexible membrane.

- Drying time: 2-4 hours
- Fix tiles after: 2-4 hours



Approx 8m ²	N5200100
------------------------	----------

Nicobond Wet Room Self Adhesive Tanking Sheet

A highly flexible & robust self adhesive butyl rubber /polypropylene tanking sheet for effective waterproofing of walls and floors.

- Thickness: 1.5mm
- Tensile Strength: 7N/mm²

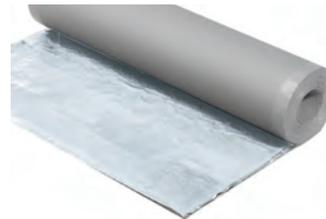

10m x 1000mm	N5200180
--------------	----------

Nicobond Wet Room Waterproofing Tape Roll

A strong reinforcing tape for internal corners and floor and wall joints.

- Durable and flexible
- Self adhesive



20m x 80mm	N5200125
------------	----------

Nicobond Wet Room Waterproof Internal and External Corners

Already cut waterproof internal and external corners which save time.

- Durable and flexible
- Self adhesive
- Saves time cutting to fit



Internal 140 x 140mm	N5200130
External 140 x 140mm	N5200140

Nicobond Wet Room Waterproof Pipe Collars

For efficient sealing around pipework, valves & drainage outlets. Remove the backing paper and press the collar firmly into position.

- Durable and flexible
- Self adhesive

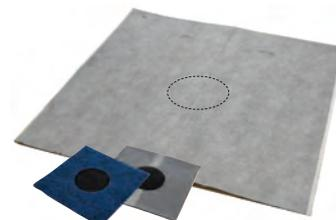

120 x 120mm	N5200160
500 x 500mm	N5200150

Nicobond PlasticPly™

2mm thick, self adhesive timber reinforcing sheet, designed to facilitate the bonding of ceramic, porcelain & natural stones to timber floors.

- 4 sheets at 600 x 500mm
- Easy to cut & no drilling needed
- Stops cracked and loose tiles



1.2m ²	N5100500
-------------------	----------



Approx 10m ²	N5200200
-------------------------	----------



Nicobond Undertile Heating Mat

The Nicobond Professional Undertile Heating Mat can be used as either a primary or secondary heat source, fitted onto Nicobond Tile Backer Board for improved insulation and connected to a Nicobond Thermostat a comfortable room temperature can be easily achieved.

- 200W/m² output
- Pre-spaced cables
- Suitable as primary heat source
- BEAB Approved and EMF safe

Covers 0.6 m ²	N2550006
Covers 1 m ²	N2550010
Covers 1.6 m ²	N2550016
Covers 2 m ²	N2550020
Covers 2.6 m ²	N2550026
Covers 2.8 m ²	N2550028
Covers 3.5 m ²	N2550035
Covers 4.2 m ²	N2550042
Covers 5.4 m ²	N2550054
Covers 6 m ²	N2550060
Covers 6.7 m ²	N2550067
Covers 7.5 m ²	N2550075
Covers 8.9 m ²	N2550089
Covers 9.9 m ²	N2550099



Nicobond Digital Thermostat

An advanced 7 day programmable thermostat for undertile heating.

- Digital display with light
- Program selection/night setback
- Parental lock
- Double insulated sensor included

White	N2552124
-------	----------



Nicobond Professional Undertile Heating Mat

A fast-to-fit undertile heating mat system designed to provide energy-efficient floor warming in all rooms and a full heating system in well insulated areas. With the wire pre-spaced and affixed to a mat, installation time is greatly reduced compared to using a loose wire system

- 150W/m² output
- Easy to install pre-spaced cables
- Ideal for efficient floor warming
- Suitable as sole heat source in well insulated rooms
- Lower initial cost option

Covers 1 m ²	N2551802
Covers 1.5 m ²	N2551805
Covers 2 m ²	N2551808
Covers 2.5 m ²	N2551811
Covers 3 m ²	N2551814
Covers 4 m ²	N2551817
Covers 5 m ²	N2551820
Covers 6 m ²	N2551823
Covers 7 m ²	N2551826
Covers 8 m ²	N2551829
Covers 9 m ²	N2551832
Covers 10 m ²	N2551835



Nicobond Touchscreen Thermostat

Easy to use colour touchscreen display Thermostat for use with undertile heating

- Energy usage information & diagnostic data
- 16 amp – 3800W
- Can operate up to 6 events per day
- Includes simple manual mode

White	N2552110
-------	----------



Undertile Heating Cable

The Undertile Heating Cable is supplied as loose cable for easy positioning and installation. Kits are available according to the room size or floor area required. The use of Nicobond Tile Backer Board and Nicobond Thermostats ensure a thoroughly efficient heating system to benefit any living area.

- BEAB approved and EMF safe

1-1.3 m ²	200W	N2550200
1.5 - 2.0 m ²	300W	N2550300
2.0 - 2.7 m ²	400W	N2550400
3.0 - 4.0 m ²	600W	N2550600
4.0 - 5.3 m ²	800W	N2550800
5.0 - 6.7 m ²	1000W	N2551000
7.0 - 9.3 m ²	1400W	N2551400
8.0 - 10.7 m ²	1600W	N2551600



Nicobond Touchscreen Thermostat Conversion Kits

To complement our Nicobond Touchscreen Thermostat we offer four conversion kits to enhance its appearance.

- East to fit during or after installation
- Made from solid metal & glass

Black Glass	N2552109
White Glass	N2552108
Brushed Aluminium	N2552112
Chrome	N2552111

4

Wet Room Screens/Panels

Our high quality wet room screens are made from high quality toughened glass and are available in endless sizes, configurations and panel options to suit the shape of the bathroom, helping to open up & utilise your space.



Corner Wall/End Panel

This is a popular wet room configuration used within standard sized UK bathrooms. The configuration enables the wet area to be positioned in the corner of the room between a wet room panel and wall for efficient use of space.



Free Standing

A freestanding wet room configuration allows for flexibility and a dual access wet area for the ultimate in class and a statement appearance.



Bi-Fold Shower Doors

Allows users to fold the wet room screens back to utilise the space in the bathroom. Great option for small bathrooms with little room to manoeuvre. If caring for a dependent loved one, we offer a split screen option too.



Sliding Shower Doors

Our sliding shower doors are the perfect solution for bathrooms with little space for shower doors to operate. The soft close function and smooth operation means that a sliding door adds a luxurious touch.



Deflector Panel Fixed

Our fixed deflector panel allows for the minimal appearance with added protection from water escaping from the wet area.



Deflector Panel Pivot

Our pivot deflector panel allows for users to easily enter and exit the shower area with ease as it acts as a partial enclosure for the wet area.

Fluidity

Fluidity is an elegant range of sliding wet room screens with a unique soft close door system. This high quality, robust system requires the gentlest of touches to operate the doors. Perfect for creating a seamless transition from bathroom or bedroom to wet area.





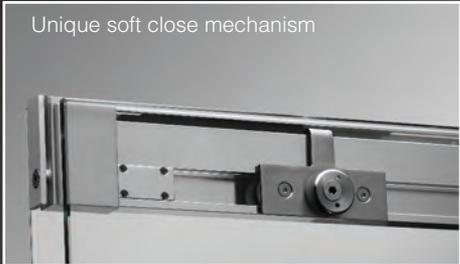

Fluidity Gaia has the same spec as Fluidity, without soft close doors

Left hand illustrated

Fluidity Sliding Soft Close Door

- 8mm toughened safety glass
- 6mm fixed glass
- Clear glass
- Soft close mechanism
- Barrier free entry
- Easy cleaning slider release
- Chrome frame
- 2000mm high

		Left Hand	Right Hand
1000mm	950-990mm	P6832731	P6832730
1080mm	1050-1090mm	P6832735	P6832734
1200mm	1150-1190mm	P6832741	P6832740
1300mm	1250-1290mm	P6832745	P6832744
1400mm	1350-1390mm	P6832751	P6832750
1500mm	1450-1490mm	P6832755	P6832754
1600mm	1550-1590mm	P6832761	P6832760
1700mm	1650-1690mm	P6832765	P6832764
1800mm	1750-1790mm	P6832771	P6832770

Fluidity Gaia Sliding door

- 6mm toughened safety glass
- 6mm fixed glass
- Clear glass
- Barrier free entry
- Easy cleaning slider release
- Chrome frame
- 2000mm high

		Left Hand	Right Hand
1200mm	1150-1190mm	P6832611	P6832610
1400mm	1350-1390mm	P6832613	P6832612
1500mm	1450-1490mm	P6832615	P6832614
1700mm	1650-1690mm	P6832619	P6832618
1800mm	1750-1790mm	P6832621	P6832620



Fluidity Sliding Soft Close Double Door

- 8mm toughened safety glass
- 6mm fixed glass
- Clear glass
- Unique soft close mechanism
- Step free entry
- Easy cleaning slider release
- Chrome frame
- 2000mm high

1400mm	1360-1400mm	P6832800
1500mm	1460-1500mm	P6832802
1600mm	1560-1600mm	P6832805
1700mm	1660-1700mm	P6832808
1800mm	1760-1800mm	P6832810



Fluidity Door Side Panels

- 6mm toughened safety glass
- Clear glass
- Chrome frame
- 2000mm high

700mm	670-690mm	P6832780
740mm	720-740mm	P6832782
800mm	770-790mm	P6832785
840mm	820-840mm	P6832787
900mm	870-890mm	P6832790

Fluidity Gaia Sliding Double Doors

- 6mm toughened safety glass
- Clear glass
- Barrier free entry
- Easy cleaning slider release
- Chrome frame
- 2000mm high

1400mm	1360-1400mm	P6832625
1500mm	1460-1500mm	P6832626
1700mm	1660-1700mm	P6832628
1800mm	1760-1800mm	P6832629



Enhance

Enhance offers you a stylish and sophisticated wet room look with a square edged design. Enhance is available in 5 different configurations and up to 9 sizes with panels that can be added for a bespoke solution. Also available with a matching chrome bracing bar in various options to suit your space.



Achieve flexibility with
endless size and design options...

Enhance Wet Room Screen

- 8mm clear toughened safety glass
- Suitable for shower trays or wet floor installations
- 2000mm high



Front Wet Room Panel

Size	Actual width	
600mm	567mm	S6100480
700mm	667mm	S6100481
760mm	727mm	S6100482
800mm	767mm	S6100483
900mm	867mm	S6100484
1000mm	967mm	S6100485
1100mm	1067mm	S6100486
1200mm	1167mm	S6100487

Corner Wet Room Panel

- Includes corner fixing kit

Size	Actual width	
600mm	565mm	S6100471
700mm	665mm	S6100472
760mm	725mm	S6100473
800mm	765mm	S6100474
900mm	865mm	S6100475
1000mm	965mm	S6100476
1100mm	1065mm	S6100477
1200mm	1165mm	S6100478
1400mm	1365mm	S6100479

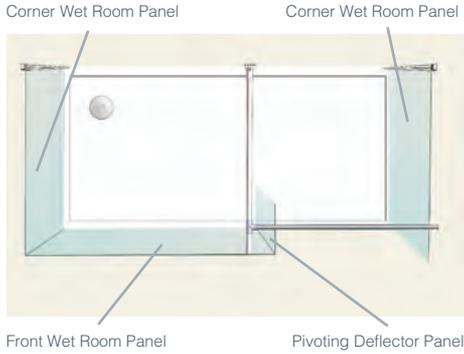

Freestanding Panel

- Includes freestanding floor kit

1000mm	955mm	S6100379
1100mm	1067mm	S6100381
1200mm	1167mm	S6100383
1400mm	1355mm	S6100385

Fixed Deflector Panel

- Includes fixed corner fixing kit

200mm	226mm	S6100488
-------	-------	----------

Pivoting Deflector Panel

- Includes pivoting corner fixing kit

200mm	243mm	S6100489
300mm	343mm	S6100490
400mm	443mm	S6100491

Bracing Bars



Low Level

1030mm	S6100492
--------	----------



Ceiling

560mm	S6100494
-------	----------



Floor to Ceiling

2700mm high	S6100495
-------------	----------



High level

1135mm	S6100496
--------	----------



Side panel kit

use with S6100492	S6100493
-------------------	----------

Vinyl flooring countour profile kit	S6100497
--	----------

Silhouette

A range of shower panels and fixings that are combined to create an arrangement designed to fit various bathroom shapes and sizes.

This range offers two beautiful curved glass shower panel options for both recess and corner arrangements. Within this range there is an option of curved hinged deflector panels or curved glass panels which liberates even more space within your bathroom.

Maximise your space with our unique curved screen...



Silhouette Shower Screen

- 8mm curved wet room screen clear glass
- Silver frame
- 1952mm high



Wet room Screen

1000mm	S6100575
1200mm	S6100576



Deflector Panel

	Left hand	Right Hand
300mm	S6100588	S6100589



Side Panel

700mm	S6100590
800mm	S6100591
900mm	S6100592

Curved Wall Profile

- Curved wall profile kit for wetfloor installations

25 x 10mm	S6100582
-----------	----------

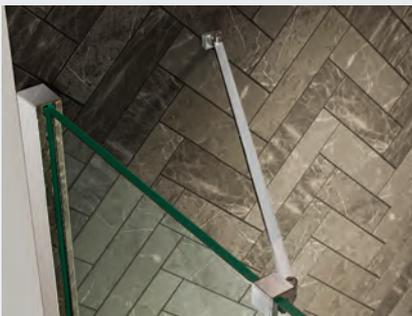

Stabilising Bar

- Glass to wall angled corner bar
- Chrome finish
- Adds 12mm to top of glass panel

300mm	S6100583
500mm	S6100584

Front Panel To Wall Fixing Kit

- Chrome finish
- Can be trimmed
- Adds 35mm to top of glass panel when fitted

1000mm	S6100577
--------	----------



Ceiling Stabilising Bar

- Can be trimmed

600mm	S6100585
-------	----------

Side Panel Fixing Kit

- Chrome finish
- Can be trimmed
- Adds 35mm to top of glass panel when fitted

1000mm	S6100579
--------	----------

Finesse Two

This frameless, elegant wet room screen will enhance any showering space by enabling freedom of movement unhindered by traditional enclosure frames.



Open up and utilise your spaces...





Finesse Two Wet Room Screen

- 8mm clear toughened safety glass
- Chrome profiles
- Reversible
- 90° wall support included
- Flexible seal
- Suitable for trays and wet floors
- 2000mm high



Speed of Installation

The glass panel is secured with a flexible seal.



Modular System

The mobile panel is attached by a unique clamping hinge providing limitless flexibility.



Freestanding

900mm	P6832715
1000mm	P6832716
1200mm	P6832717
1400mm	P6832718

Corner Wall/End Panel

300mm	P6832700
400mm	P6832701
500mm	P6832702
600mm	P6832703
700mm	P6832704
800mm	P6832705
900mm	P6832706
1000mm	P6832707
1200mm	P6832708
1400mm	P6832709

Deflector Panel

300 x 6mm	P6832720
-----------	----------

- 8mm clear toughened safety glass
- Chrome profiles
- 2000mm high

Finesse Two Reflex

Finesse Two Reflex is an innovative range of mirrored effect shower screens which complete the look of your showering area. It's unique mirrored effect makes the room look bigger by reflecting light and creating the illusion of space. Also a great option if you require some assistance during showering and would like to maintain a level of privacy.

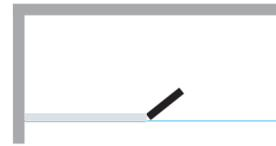

Finesse Two Reflex Shower Screen

- 6mm chrome treated toughened safety glass
- Mirror effect on both sides
- Reversible
- Oxide, scratch, acid and salt spray resistant
- Chrome profiles
- 45° or 90° wall support
- Flexible seal
- Suitable for trays and wet floor
- 2000mm high

Reflex Corner Wall/End Panel

300mm	P6832687
400mm	P6832688
500mm	P6832689
600mm	P6832690
700mm	P6832691
800mm	P6832692
900mm	P6832693
1000mm	P6832694
1200mm	P6832695
1400mm	P6832696

Reflex Deflector Panel

300mm	P6832697
400mm	P6832698

Freespace Two

Freespace Two is our innovative, award winning, multi-user collection that incorporates unique folding door and split screen functionality. Freespace Two enables total accessibility and opens up a whole new generation of wet room showering.

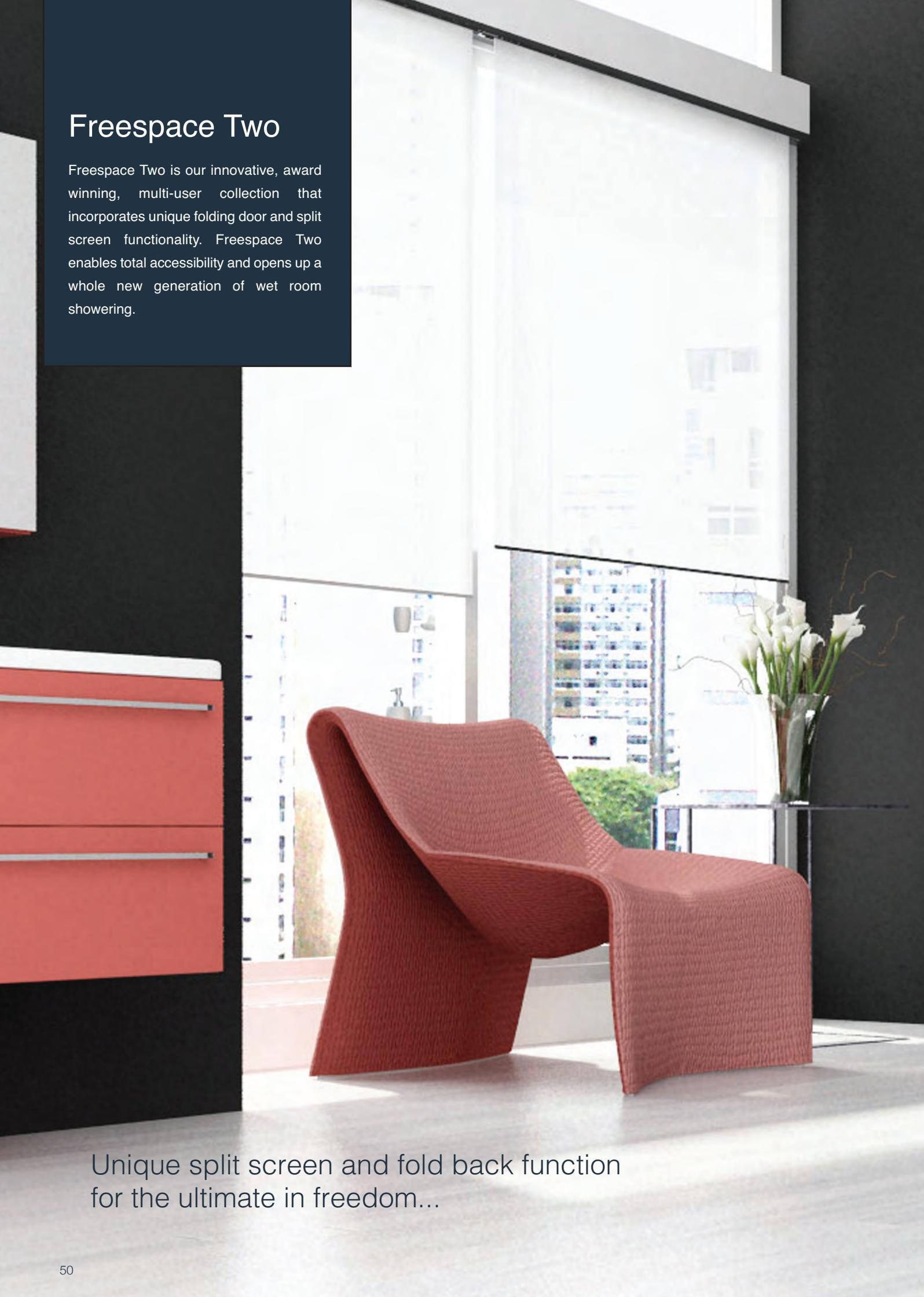

Unique split screen and fold back function for the ultimate in freedom...





Order one left & one right hand to create a corner or in-line enclosure

Freespace Two Shower Screen

- 6mm clear toughened safety glass
- Chrome finish
- Suitable for in-line and corner installations
- Unique split screen
- Rising hinge system on both folding panels
- 2000mm full height
- 1000mm half height
- Fold doors back against the wall in both directions
- Supplied with an extension profile 25 x 15mm to complete in-line lengths



Perfect when caring for loved ones who require assistance

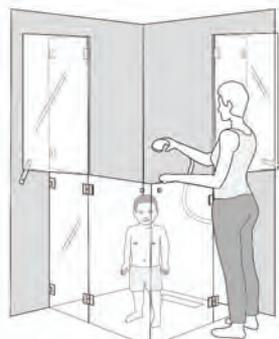

Great for showering young ones



Beneficial for households with pets

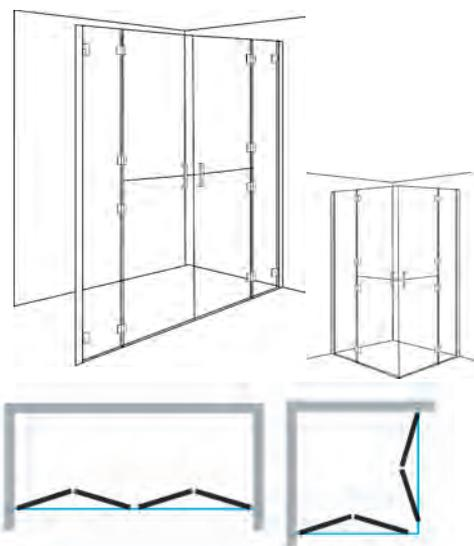

Full Height Bi-fold Shower Doors with split doors

Left hand Right Hand

	Left hand	Right Hand
580 - 600mm	P6840031	P6840030
630 - 650mm	P6840033	P6840032
680 - 700mm	P6840035	P6840034
730 - 750mm	P6840037	P6840036
780 - 800mm	P6840039	P6840038
830 - 850mm	P6840041	P6840040
880 - 900mm	P6840043	P6840042
930 - 950mm	P6840045	P6840044
980 - 1000mm	P6840047	P6840046
1030 - 1050mm	P6840049	P6840048
1080 - 1100mm	P6840051	P6840050
1130 - 1150mm	P6840053	P6840052
1180 - 1200mm	P6840055	P6840054

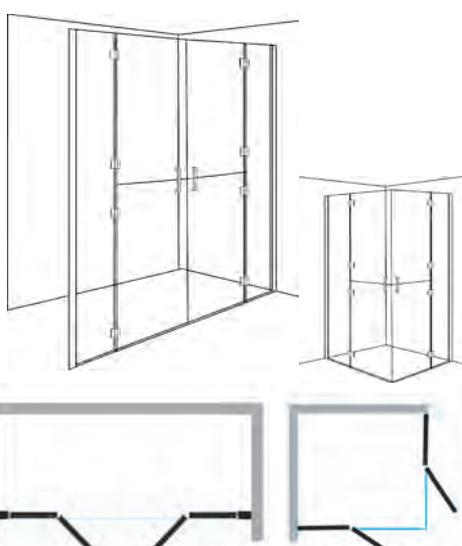

Full Height Fixed Panel/Shower Doors with split doors

Left hand Right Hand

	Left hand	Right Hand
780 - 800mm	P6840061	P6840060
830 - 850mm	P6840063	P6840062
880 - 900mm	P6840065	P6840064
930 - 950mm	P6840067	P6840066
980 - 1000mm	P6840069	P6840068
1030 - 1050mm	P6840071	P6840070
1080 - 1100mm	P6840073	P6840072
1130 - 1150mm	P6840075	P6840074
1180 - 1200mm	P6840077	P6840076

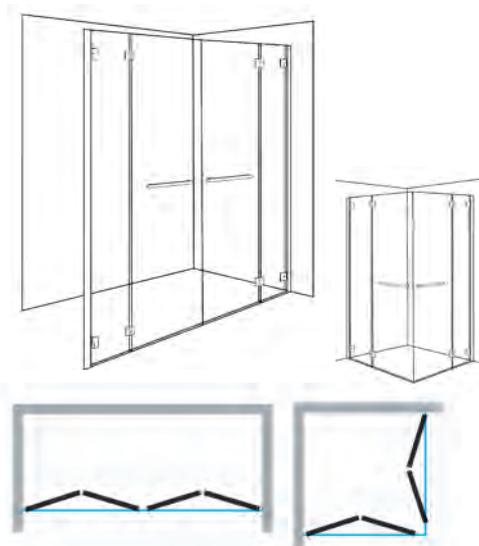

Full Height Bi-fold Shower Doors

Left hand Right Hand

	Left hand	Right Hand
1170-1210	P6840081	P6840080
1270-1310	P6840083	P6840082
1370-1410	P6840085	P6840084
1470-1510	P6840087	P6840086
1570-1610	P6840089	P6840088
1670-1710	P6840091	P6840090
1770-1810	P6840093	P6840092
1870-1910	P6840095	P6840094
1970-2010	P6840097	P6840096
2070-2110	P6840099	P6840098
2170-2210	P6840101	P6840100
2270-2310	P6840103	P6840102
2370-2410	P6840105	P6840104

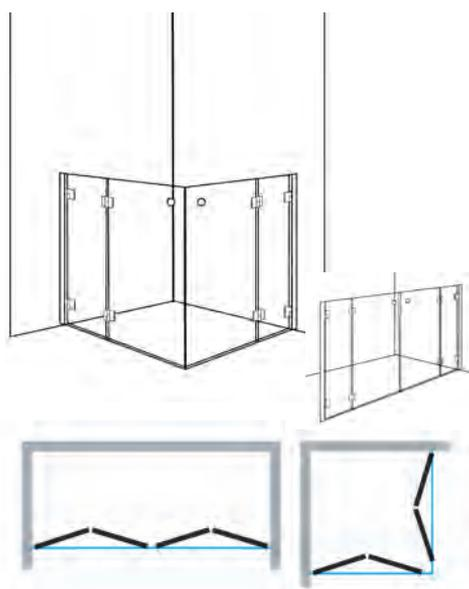

Half Height Bi-fold Shower Doors

Left hand Right Hand

	Left hand	Right Hand
580 - 600mm	P6840001	P6840000
630 - 650mm	P6840003	P6840002
680 - 700mm	P6840005	P6840004
730 - 750mm	P6840007	P6840006
780 - 800mm	P6840009	P6840008
830 - 850mm	P6840011	P6840010
880 - 900mm	P6840013	P6840012
930 - 950mm	P6840015	P6840014
980 - 1000mm	P6840017	P6840016
1030 - 1050mm	P6840019	P6840018
1080 - 1100mm	P6840021	P6840020
1130 - 1150mm	P6840023	P6840022
1180 - 1200mm	P6840025	P6840024

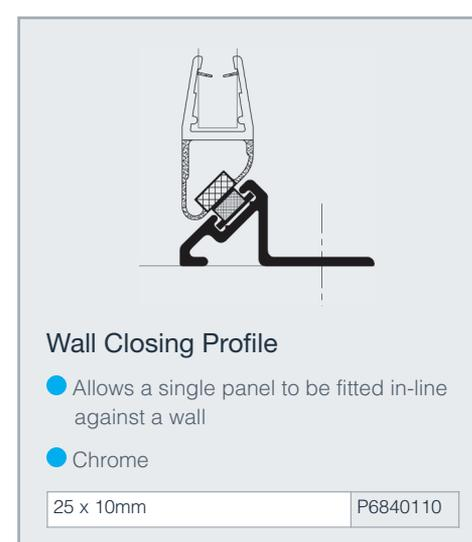

Wall Closing Profile

● Allows a single panel to be fitted in-line against a wall

● Chrome

25 x 10mm

P6840110

Extension Profile

● Required when the full height bi-fold doors are being used in-line

● Chrome

25 x 15mm

P6840194

Creative

A polished square edge range of shower screens that creates a modern versatile finish within any bathroom. With three configurations available you can choose one that suits your bathroom space. This range guarantees you additional support through the 3.3m adjustable telescopic ceiling support.

Attractive, square edge screen design with a telescopic ceiling support





Creative Shower Screen

- 6mm clear toughened safety glass
- Square edge chrome profiles
- Reversible
- Suitable for shower tray or wet room
- Telescopic ceiling support, 3.3m adjustment
- Free standing and corner wall versions
- 2000mm high

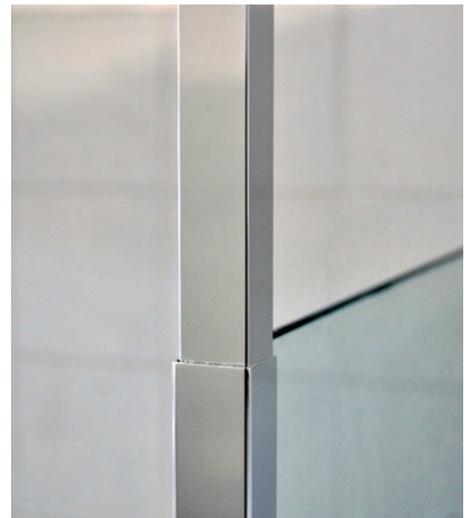

Freestanding Panel

690mm	P6840150
790mm	P6840151
890mm	P6840152
990mm	P6840153
1190mm	P6840154
1390mm	P6840155



Corner Wall Panel

690-700mm	P6840156
790-900mm	P6840157
890-900mm	P6840158
990-1000mm	P6840159
1190-1200mm	P6840160
1390-1400mm	P6840161

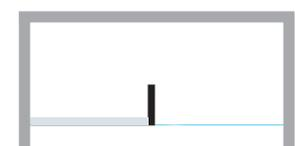

Fixed Deflector Panel

- Supplied with corner connections profile

310mm	P6840162
410mm	P6840163
510mm	P6840164

Creative Reflex

Creative Reflex shower screens create a unique look within the bathroom through their stunning mirrored effect. This range is available in various sizes to suit all types of bathrooms.



Creative Reflex Shower Screen

- 6mm chrome treated toughened safety glass
- Mirror effect, oxide, scratch, acid and salt spray resistant on both sides
- Square edge chrome profiles
- Reversible
- Telescopic ceiling support with 3.3mm adjustment
- 2000mm high



Corner Shower Screen

490-500mm	P6840176
590-600mm	P6840177
690-700mm	P6840178
790-800mm	P6840179
890-900mm	P6840180
990-1000mm	P6840181
1190-1200mm	P6840182
1390-1400mm	P6840183

5 Tiles

Achieve slip resistant flooring

N&C are one of the largest UK distributors of ceramic, porcelain and natural stone wall and floor tiles in the UK. We are unique in offering a large collection of slip resistant floor tiles that meet a Pendulum Test Value of 36+ and deemed suitable for a wet floor and with bare foot slip resistance by the requirements set out by the Health & Safety Executive (HSE) for the UK market.

The tests carried out on our slip resistant tiles use a specialist rubber to simulate the slip resistance characteristics of a barefoot pedestrian, when assessing floor surfaces for use in shower areas, changing rooms and swimming pools.

It is important to consider that there are currently only two different types of rubber defined within BS 7976-1: 2002, and the UKSRG Guidelines, for use in the measurement of the floor surface slipperiness of pedestrian surfaces with the pendulum. Slider 96, also known as Four-S (Standard, Simulated Shoe Sole) rubber, is a material developed to be representative of shoe soling material of moderate slip resistance. Slider 55, also known as TRL or TRRL rubber, is a softer rubber compound used to simulate barefoot slip resistance.

All Pendulum Test Values achieved are 36+, these are therefore all classified as a 'low slip potential'.



We are unique in owning the UK's first digital pendulum testing system.

All of the tiles shown are tested using Slider 55



Progress 443 x 888mm

Progress is a comprehensive porcelain range of wall and floor tiles, with complementing mosaics made up by 6 cool and warm on-trend colours. Maximise the sense of space in a wet room with this oversized porcelain tile to create visually unified and sophisticated interiors.

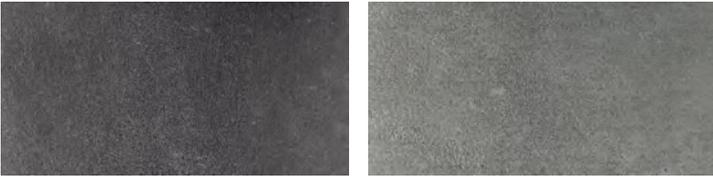

Black Natural	NB189823	Dark Grey Natural	NB18982
---------------	----------	-------------------	---------



Silver Grey Natural	NB18980	Alabaster Natural	NB18978
---------------------	---------	-------------------	---------



Stone Natural	NB18979	Clay Natural	NB18981
---------------	---------	--------------	---------

Mosaic 295 x 295mm

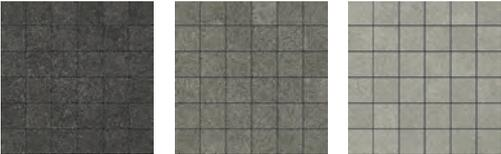

Black NB18969	Dark Grey NB18968	Silver Grey NB18966
------------------	----------------------	------------------------



Alabaster NB18964	Stone NB18965	Clay NB18967
----------------------	------------------	-----------------



Future Stone 600 x 600mm

The latest, innovative inkjet technology enables you to benefit from the intricate beauty of natural marble whilst attaining the benefits of hard wearing porcelain floors. Matching ceramic wall tiles also available.



Surface 300 x 600mm

Surface is our most dynamic range that allows you to extend your existing spaces from room to room for a seamless environment throughout the home, office or commercial setting.



Bone NB19404



Grey NB19405



Dark Graphite NB19003



Light Graphite NB19002



Sand NB19001



Warm White NB19000



Diverse Slate 400 x 600mm

Diverse Slate uses state of the art digital reproduction techniques to create one of the most visually stunning tiles ever made. Taking its inspiration from the natural stone, Oyster Slate, each tile is designed to embody the look and feel of this stone, thus making each tile dramatically different.



Diverse Slate NB19905



Cityscape 300 x 300mm - 300 x 600mm

On-trend through bodied porcelain tiles, closely replicating the varied nature of natural Quartzstone. Combine with mosaics to create a unique look.



Grey NB19256



Beige NB19259

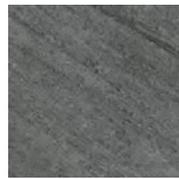

Black NB19262



Grey NB19296



Beige NB19297



Black NB19298



Wood Spirit 200 x 1140mm

Opt for Wood Spirit, a hard wearing porcelain floor tile with the beautifully diverse nature of real wood. Wood Spirit uses the latest in manufacturing technology to create the perfect replication of wood with high definition detail. The three contemporary colours blend perfectly into the series. The functional characteristics outweigh that of real wood, resulting in a wood that can be used in wet areas.



Ash

NB18935



Oak

NB18936



Teak

NB18937

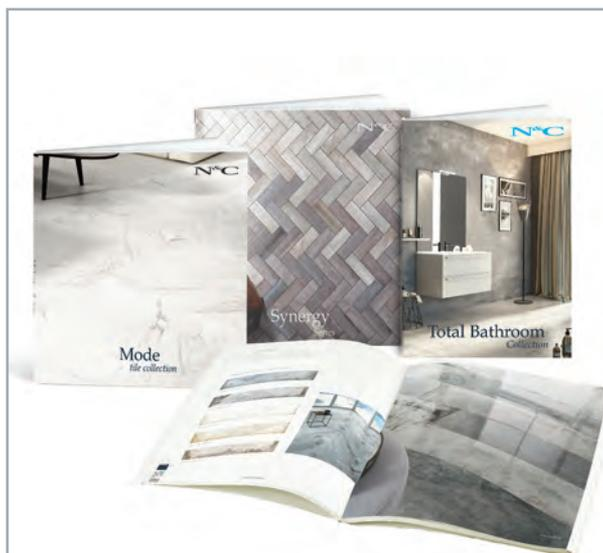

Browse our comprehensive on-trend tile and bathroom catalogues...

Browse hundreds of tile ranges in our latest Mode and Synergy tile catalogues, filled with inspirational ideas and large format pages for easier selection.

Complete your wet room with one of our attractive, high quality bathroom suites and accessories from our Bathroom Collections catalogue.

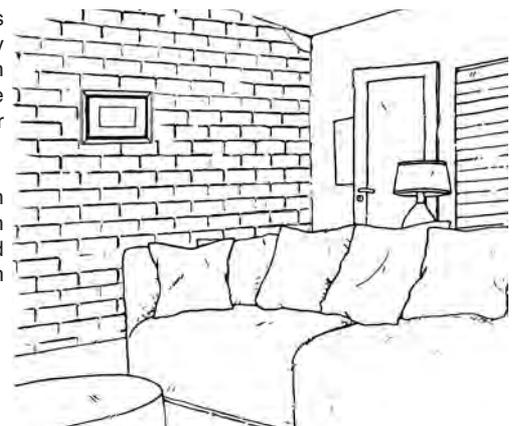

Request or view the catalogues online at www.nichollsandclarke.com/downloads



Time 600 x 600mm - 300 x 600mm

The Time range is our most comprehensive collection, enabling us to offer our clients choice and flexibility. Time is constructed of rectified full bodied double loaded, porcelain stoneware, with high level of technical characteristics offered in a blend of warm and cool tones, true to the ethos of Synergy.

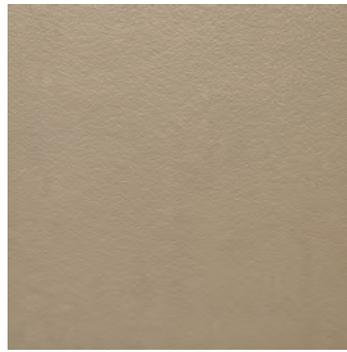

Beige NB18774



Carbon NB18775



Beige NB18804



Carbon NB18805

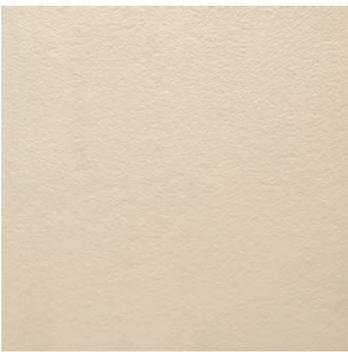

Snow NB18770



Cream NB18771



Silver NB18772



Black NB18773



Snow NB18800



Cream NB18801



Silver NB18802



Black NB18803

Complimentary colours and sizes are also available in natural and polished finish (not PTV 36+)

Mosaic 300 x 300mm

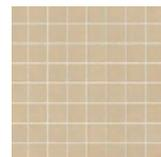

Beige NB18846

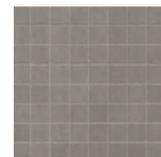

Carbon NB18849

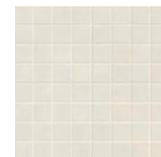

Snow NB18841



Cream NB18842



Silver NB18843



Black NB18844

Experience

Established in 1875, Nicholls & Clarke has pedigree that has been developed over many years. Through great heritage, we have gained a depth of knowledge and invaluable experience in the manufacturing and supplying of bathroom products to the construction market. We have experience across many industries with a huge portfolio of products suited to all project environments.

Total Solution Providers

As part of the Nicholls & Clarke Group, we have the ability to offer the complete bathroom solution through a comprehensive range of quality products, so that you can benefit from dealing with one source, making it easier to co-ordinate project supplies.

Inventors & Innovators

N&C have been introducing innovative products to the bathroom industry from the early years, such as the invention of the raised height pan. We continue to be at the forefront of innovation, embracing new technology within the industry and better defining our portfolio of products that perform, but where quality and functionality are at its peak. As inventors, we continue to engage in research and development and have spent decades developing innovative bathroom products that solve the challenges faced in today's construction industry.

Warranties

N&C products are manufactured to such high and exacting standards enabling us to offer excellent warranties on all of our bathroom products. Our shower enclosures and wet room screens have up to a lifetime warranty, our shower trays and sanitaryware have up to 25 years warranty, our taps and showers have up to 12 years warranty and our baths and vanity furniture have up to 10 years.

Research & Development

Investment in the latest manufacturing equipment and testing facilities allow us to push forward with the development of new technology and raw material that will further enhance product performance and handling characteristics. Prior to going to market, we undergo rigorous testing of all our products to ensure that performance is to a high standard. All products are tested to meet the relevant standards and regulations.

Environment

As an ISO14001 company, sustainability is a core part of our company agenda. As well as various carbon offsetting programmes in place, we invest a great deal in manufacturing and developing solutions dedicated to reducing our carbon footprint, and in turn increasing our customers' green credentials.

Training

We offer practical training courses at our 120,000 square foot head office facility. Our team of experts will demonstrate and give clients and customers the opportunity to get hands on with our range of products. For further information please contact our Head Office on 020 8586 4600 or email us at info@nichollsandclarke.com

Customer Care

We aim to provide you with an outstanding level of customer service that will help to further enhance the service you offer to your clients. We monitor our performance levels and strive to achieve 100% client satisfaction. We believe that open channels of communication with our customers, coupled with their feedback are a sure way of further improving our customers buying experience.

British Manufacture

Our three state of the art U.K manufacturing facilities comply with ISO 9001 and ISO 14001, utilise the latest manufacturing technologies and apply stringent quality control checks during every part of the manufacturing process. Only the highest quality raw materials, product formulations and packaging materials are used, ensuring the finished product meets our exacting standards, far exceeding those of the latest European standards.

Trade Associations & Technical Committees

N&C have been heavily involved in the creation of British & European Standards for decades. We have chaired the TTA Wetroom Technical Committee. We continue to push for stringent policing of the industry. Our philosophy has always been to drive up quality and standards whilst remaining highly competitive.

24 Hour Nationwide Delivery

Nicholls & Clarke are unique in being able to offer nationwide, next day delivery, even when you order up to 5pm the day before' and there is no minimum order requirement. N&C operates from 18 branches nationwide offering localised delivery or, with thousands of product lines in stock, you also have the option to collect.

Technical Service

The Nicholls & Clarke technical team has extensive experience in the bathroom industry. We are able to offer a full technical specification service and are available to attend any site address throughout the U.K. A technical written specification is available on request.

Product Quality

All of our bathroom products are tried and tested to great depth prior to being introduced into the marketplace. Our wet room components have been manufactured to high quality to ensure total confidence in the market. Our Premier Shower Decks have undergone independent testing, being tested against other key manufacturers decks. The results proved that under the test parameters, Premier Shower Deck was the strongest deck when compared to the those tested.

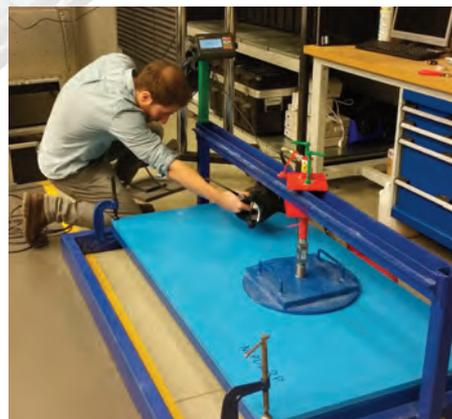

Total Solution

provider



WETROOMS

As manufacturers of the complete system, N&C offer every component required to create a stylish, level access showering environment.



ADHESIVES

We manufacture innovative, high performance adhesives, grouts and tiling systems through our Nicobond brand, within our UK based factory.



WALL & FLOOR TILES

N&C are leading suppliers of award winning ceramic, porcelain and natural stone wall and floor tiles.

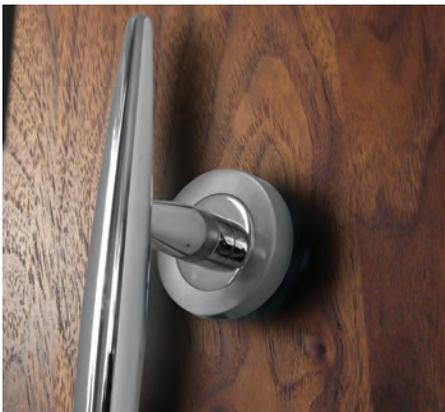

IRONMONGERY

As ironmongers since 1875, and as part of the Guild of Architectural Ironmongers, we specialise in everything required in washrooms

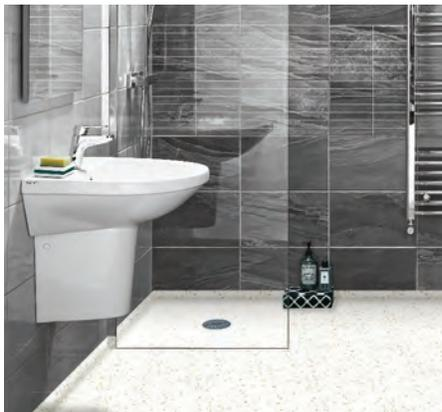

FLOORING

As leading manufacturers, we provide quality materials for required safety flooring, such as Altro, vinyl tiles and screeds.



BATHS

From contemporary and classic, we have a broad collection of baths in a range of shapes and styles perfect for hotels.



INDEPENDENT LIVING

Through our Phlexicare brand, N&C are leading manufacturers and distributors of independent living solutions designed for people with all levels of abilities, covering accessible showering, multi user kitchens and more.



DECORATING

Our builders merchant division offers all the popular trade brands for decorators and building professionals.



GLASS & GLAZING

As the UK's leading independent supplier of commercial and domestic glass and glazing products, we can offer unrivalled solutions at competitive prices.

Contact your local branch or Sales Representative for dedicated literature.
Alternatively, visit www.nichollsandclarke.com



Distribution Centres, Trade Counters & Showrooms

N&C Building Materials
 41-51 Freshwater Road
 Chadwell Heath

Romford, Essex RM8 1SP
 Tel: 020 8586 4600
 Fax: 020 0586 4646

Unit C1
 Cothill Industrial Estate
 Plympton, **Plymouth** PL7 1SR
 Tel: 01752 339724
 Fax: 01752 342746

Units B1/B3
 Sneyd Trading Estate
 Sneyd Hill, Burslem
Stoke-on-Trent ST6 2PA
 Tel: 01782 575727
 Fax: 01782 575641

Units 3 & 4 Cardiff Trade Park
 Hadfield Road
Cardiff CF11 8AQ
 Tel: 029 2039 0146
 Fax: 029 2022 4356

26 Colquhoun Avenue
 Hillington Industrial Estate
 Hillington, Scotland
Glasgow G52 4BN
 Tel: 0141 880 1200
 Fax: 0141 880 1212

Unit 4 Waterloo Industrial Estate
 Flanders Road, Hedge End
Southampton SO30 2QT
 Tel: 01489 779700
 Fax: 01489 779701

Nicholls & Clarke
 Est 1875

Trade Counters & Showrooms

Units 1A/B Alexander Place
 Lower Park Road
New Southgate
 London N11 1QD
 Tel: 020 8361 6050
 Fax: 020 8361 4757

Unit 14 Meridian Trading Estate
 Bugsby Way, **Charlton**
 London. SE7 7SJ
 Tel: 020 8269 5960
 Fax: 020 8269 5961

Units 10, 11, 14 & 15
 Advent Business Park
 Advent Way
Edmonton N18 3AF
 Tel: 020 8807 3227
 Fax: 020 8807 3223

Unit 8 Ascent Park
 Edinburgh Way
Harlow, Essex CM20 2HW
 Tel: 01279 621980
 Fax: 01279 621981

Unit1 Cliffside Trade Park
 Motherwell Way
Lakeside, West Thurrock
 Essex RM20 3XD
 Tel: 01708 680180
 Fax: 01708 680181

2 - 3 Albarn Close
 Wyncolls Road
 Severalls Park
Colchester Essex CO4 9HY
 Tel: 01206 849300
 Fax: 01206 845878

Unit 9 -11 McDonald Business Park
 Maylands Avenue
Hemel Hempstead
 Hertfordshire HP2 7EB
 Tel: 01442 234635
 Fax: 01442 279501

Unit 8D Pompey Centre
 Fratton Way Southsea
Portsmouth PO4 8TA
 Tel: 02392 894599
 Fax: 02392 894598

Unit 5 Tower Court
 St. David's Road Swansea
 Enterprise Park
Swansea SA6 8QL
 Tel: 01792 797337
 Fax: 01792 774019

25 Gunnels Wood Park
 Gunnels Wood Road
Stevenage
 Hertfordshire SG1 2BH
 Tel: 01438 315400
 Fax: 01438 740338

Unit E5
 Copley Hill Trading Estate
 Whitehall Road
Leeds LS12 1HE
 Tel: 0113 243 5644

Leofric House
 Off Phoenix Way
 Waterman Road
Coventry CV6 5TP
 Tel: 02476 705300
 Fax: 02476 705301